



Cooled Scientific Digital Cameras

User Guide

CC215MU, CC505MU, CC895MU

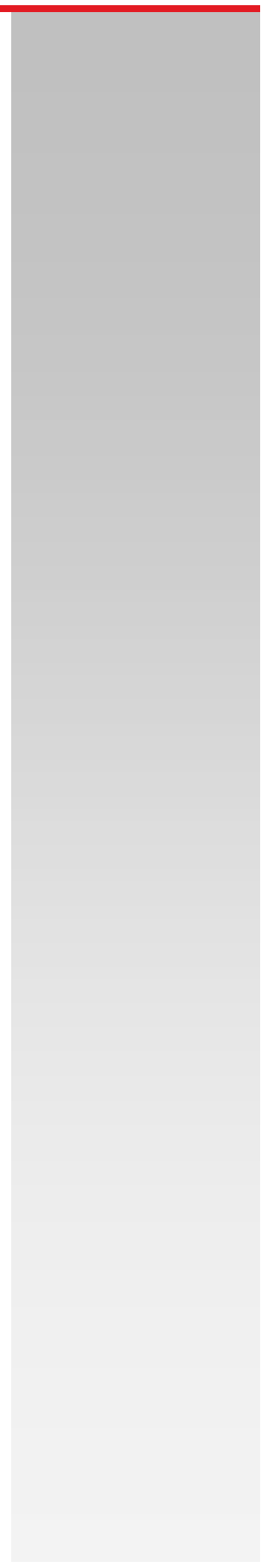

Table of Contents

Chapter 1	Safety	1
	1.1. Precautions	1
	1.2. Warning Symbol Definitions	2
	1.3. Product Care	3
	1.3.1. Service	3
	1.3.2. Accessories and Customization	3
Chapter 2	Description	4
	2.1. Introduction	4
	2.2. Receiving and Unpacking	4
	2.3. Supplied Equipment	5
	2.3.1. Optional Items	5
Chapter 3	Setup & Installation	6
	3.1. Pre-Installation - USB 3.0	6
	3.2. Installing the Software	6
	3.2.1. Download and Run the Installation File	6
	3.2.3. Driver Selection	6
	3.2.4. Installing 3 rd Party Software Application Support.....	10
	3.3. Connecting the Camera	11
	3.3.1. Multiple Camera Operation	11
	3.4. Optical and Mechanical Mounting Considerations	12
	3.4.1. Using a C-Mount Lens	12
	3.4.2. Mounting the Camera.....	12
	3.4.3. Using the Camera with a Cage System	13
	3.5. Optical Front End	14
	3.5.1. Description of Components.....	14
	3.6. Optical Front End Procedures	15
	3.6.1. Window Removal and Replacement Procedure	15
	3.6.2. Re-Assembly of the Window and C-Mount Adapter and Flange Focus Adjustment	15
	3.7. Auxiliary Connector	16
	3.7.1. Pin Descriptions	16
	3.7.2. Signal Descriptions	16
	3.7.3. Auxiliary I/O Cable Requirements.....	17
Chapter 4	Operation	18
	4.1. Starting the Camera	18
	4.2. Camera Timing Diagrams	19
	4.2.1. Camera-Specific Timing Considerations.....	20
	4.3. Equal-Exposure Pulse (CC215MU Quantalux Only)	21
	4.4. Hot Pixel Correction	22
Chapter 5	CC215MU Specifications	23
	5.1. sCMOS Sensor Specifications	23

5.2. Quantum Efficiency	23
5.3. Imaging Specifications.....	23
5.4. Example Frame Rates	24
5.5. CC215MU Power Consumption	24
5.6. Operating/Storage Temperatures	24
5.7. Sensor Temperatures in Cooling Mode	24
Chapter 6 CC505MU Specifications.....	25
6.1. CMOS Sensor Specifications.....	25
6.2. Quantum Efficiency	25
6.3. Imaging Specifications.....	25
6.4. Example Frame Rates	26
6.5. CC505MU Power Consumption	26
6.6. Operating/Storage Temperatures	26
6.7. Sensor Temperatures in Cooling Mode	26
Chapter 7 CS895MU Specifications.....	27
7.1. CMOS Sensor Specifications.....	27
7.2. Quantum Efficiency	27
7.3. Imaging Specifications.....	27
7.4. Example Frame Rates	28
7.5. Operating/Storage Temperatures	28
7.6. CC895MU Power Consumption	28
7.7. Operating/Storage Temperatures	28
7.8. Sensor Temperatures in Cooling Mode	28
Chapter 8 Protective Glass Window.....	29
8.1. Protective Glass Window Dimensions	29
8.2. AR-Coated Window Specifications.....	29
Chapter 9 Mechanical Drawings	30
Chapter 10 Troubleshooting.....	31
10.1. Interface	31
10.2. Optical	31
10.3. Operational.....	32
10.4. Software	32
Chapter 11 Maintenance	33
11.1. Cleaning Guidelines	33
Chapter 12 Regulatory	36
12.1. Certifications and Compliance – CE Declaration of Conformity	37



12.2. FCC Statement	38
12.3. Auxiliary I/O Cable Requirements	38
Chapter 13 Warranty	39
13.1. General Product Warranty	39
13.2. Specific Warranties and Repairs	39
Chapter 14 Thorlabs Worldwide Contacts	40

Chapter 1 Safety

1.1. Precautions

Please read the instruction manual carefully before operating your Digital Camera. All statements regarding safety and technical specifications will only apply when the unit is operated correctly.

Refer to this User's Guide whenever the following symbols are encountered on the Digital Camera and Power Supply.

 **ATTENTION** 



This symbol indicates that additional information is available in this user guide.

This equipment is intended for laboratory use only and is not certified for medical applications, including but not limited to, life support situations.

Transportation and delivery may cause the Digital Camera to be warm or cool upon receipt. Please wait for the device to reach room temperature before attempting to operate.

 **WARRANTY WARNING** 

Do not open the Digital Camera. There are no user serviceable parts in this product. Opening the device will void your warranty. Any modification or servicing of this system by unqualified personnel renders Thorlabs free of any liability. This device can only be returned when packed into the complete original packaging, including all foam packing inserts. If necessary, ask for replacement packaging. Please contact Thorlabs' Technical Support at techsupport@thorlabs.com and a member of our team will be happy to assist you.

















 **CAUTION** 

This product is powered directly from the USB 3.0 port of a host computer (not included), and from an auxiliary AC-DC power supply (included). To ensure optimal performance and the safety of the user, the host computer must use a properly grounded UL Listed or Recognized AC-DC power supply (or comparable regulatory approvals).

Dangerous voltage exists within the power supplies. Do not tamper with or open the supplies under any circumstances. Doing so may expose lethal voltage to personnel and will void the warranty of the computer and the camera.

1.2. Warning Symbol Definitions

Below is a list of warning symbols you may encounter in this manual or on your device.

Symbol	Description
	Direct Current
	Alternating Current
	Both Direct and Alternating Current
	Earth Ground Terminal
	Protective Conductor Terminal
	Frame or Chassis Terminal
	Equipotentiality
	On (Supply)
	Off (Supply)
	In Position of a Bi-Stable Push Control
	Out Position of a Bi-Stable Push Control
	Caution: Risk of Electric Shock
	Caution: Hot Surface
	Caution: Risk of Danger
	Warning: Laser Radiation
	Caution: Spinning Blades May Cause Harm

1.3. Product Care

Handle the system with care during transportation and unpacking. Bumping or dropping the system can damage the unit or lower system performance. If the system is mishandled during shipment, the optical components may become misaligned, which could lead to a decrease in the image quality. If this happens, the system will need to be realigned by qualified personnel. To ensure proper care and operation of your Cooled sCMOS Digital Camera, please follow the handling instructions below.

- Do not store or operate in a damp, closed environment.
- Do not use solvents on or near the equipment.
- Keep away from dust, dirt, and air-borne pollutants (including cigarette smoke). The system is not designed for outdoor use. Protect the equipment from rain, snow, and humidity.
- Do not expose to mechanical or thermal extremes. Protect the equipment from rapid variation in temperature.
- Handle all connectors with care. Do not use unnecessary force as this may damage the connectors.
- Clean using a soft, lint free cloth. Use of isopropyl alcohol is permitted, however do not immerse in any liquid or solvent.
- Clean any accessible optical surfaces with an appropriate optics grade tissue or cloth.

1.3.1. Service

Only trained and approved Thorlabs' personnel should service the system. Please contact Thorlabs' Technical Support at techsupport@thorlabs.com and a member of our team will be happy to assist you.

1.3.2. Accessories and Customization

Although the system is easily adapted for custom interfaces, to achieve the listed specifications, this system should only be used with accessories provided by Thorlabs. Any modification or servicing by unqualified personnel renders the warranty null and void, leaving Thorlabs free of liability. Please contact Thorlabs for questions on customization.

All cameras are supplied with one USB 3.0 cable. These cables are constructed to provide reliable data throughput at a length of 3 m. Do not replace this cable with a 3 m cable from a different vendor. The use of a shorter cable (1 m or 2 m) might be acceptable but is not guaranteed. Never use any cable that is longer than 3 m on a USB 3.0 system.

Chapter 2 Description

2.1. Introduction

The CC215MU is a 2.1 MP monochrome sCMOS camera, the CC505MU is a 5.0 MP monochrome CMOS camera, and the CC895MU is an 8.9 MP monochrome CMOS camera. All are USB 3.0, actively-cooled scientific cameras. All are compatible with many related Thorlabs products, including C-mount lenses and our 60 mm cage system. They are supported by our ThorCam camera application as well as the free Micro-Manager software. They are also supported in LabVIEW and MATLAB through our .NET interfaces for each. The CC215MU is an extension of our Quantalux® CS2100M-USB sCMOS Compact Scientific camera. The CC505MU and CC895MU are extensions of our Kiralux® CMOS Compact Scientific camera family.

The cameras are bundled with the full complement of Thorlabs Scientific Imaging (TSI) software. For end-users, the ThorCam software application provides full control of the camera through an intuitive user interface, and it allows the user to acquire, pan, zoom, analyze, and save images and metadata.

For developers, TSI also offers a Software Developer's Kit (SDK), which includes a comprehensive Application Programming Interface (API) to streamline the integration of any TSI camera into your system. After software installation, the SDK can be found in a sub-folder under C:\Program Files\Thorlabs. This is the same directory for 32- and 64-bit distributions.

This manual is a functional overview of these cameras, and it is meant to be a companion to the Camera Quick Start Guide, ThorCam User Guide, and the TSI Application Programming Interface Guide. All support documentation is available at www.thorlabs.com as well as in the C:\Program Files\Thorlabs folder following the installation of ThorCam.

2.2. Receiving and Unpacking

Your camera was thoroughly tested and carefully packed at the factory. Once the camera shipment is accepted for delivery, the carrier assumes full responsibility for its safe arrival. Should you receive your shipment with any damage—concealed or apparent—please contact the carrier at once. The carrier will instruct you on how to initiate a damage claim. If a visual inspection reveals damage upon receipt, it must be noted on the freight bill or express receipt and the notation signed by the carrier's agent. Failure to do so can result in the carrier refusing to honor the claim.

To return your camera to TSI for service, you must first contact your local Thorlabs office or distributor and request a Return Material Authorization (RMA). Returns will not be accepted without an RMA. See Chapter 13, titled "Warranty Information" for details.

2.3. Supplied Equipment

The following is a list of equipment that is supplied with your camera:

Supplied Equipment	
Interface Accessory	USB 3.0 Cable ¹ (3 m long)
Accessory	Hex Key – 5/64" (for C-mount adapter removal)
Accessory	Lens Cap
Power Supply	5V/3A AC-DC Converter ² (For TEC Cooling Power Only)

Note 1 - All cameras are supplied with one USB 3.0 cable. These cables are constructed to provide reliable data throughput at a length of 3 m. Do not replace this cable with a 3 m cable from a different vendor. The use of a shorter cable (1 m or 2 m) may be acceptable but is not guaranteed. Never use any cable that is longer than 3 m on a USB 3.0 system.

2.3.1. Optional Items

- Auxiliary I/O Patch cable – The auxiliary connector on the camera allows the user to access optional camera control and internal status signals (see Section 3.7).
Order Thorlabs 8050-CAB1 and TSI-IOBOB or TSI-IOBOB2.
- Mains Power Plug Adapters:
 - ADAPTER7 US – United States Plug Adapter For SMI18 Power Supply
 - ADAPTER7 UK – United Kingdom Plug Adapter For SMI18 Power Supply
 - ADAPTER7 EUR - European Plug Adapter For SMI18 Power Supply
 - ADAPTER7 AUS – Australian Plug Adapter For SMI18 Power Supply

Note 2: Each camera includes one of the four adapters listed above, based of the country where the order was placed. They are also each available individually from Thorlabs.

Chapter 3 Setup & Installation

3.1. Pre-Installation - USB 3.0

Your camera will only operate when connected to a USB 3.0 “SS” (Super Speed) port on your PC. USB 2.0 ports are not supported at this time. A USB 3.0 compatible port is typically blue - but not always. Look for this symbol above the port to be sure:



If your computer does not have a USB 3.0 port, it is likely an indication that it is an older machine, and you should consult our recommended configuration. If you must use that machine, Thorlabs recommends our PCIe USB 3.0 card (Thorlabs' part number USB3-PCIE).

Recommended Installation Sequence

1. Run the software installer, follow the steps outlined in the next section.
2. Connect the camera, power will be applied when connected to a USB 3.0 port. See section 3.3.
3. Your PC should discover the new USB device and install the necessary drivers. This may take a minute or so for the first instance.
4. Run the ThorCam application software.

3.2. Installing the Software

The Thorlabs camera software runs on Windows 7 and Windows 10 operating systems ONLY.

3.2.1. Download and Run the Installation File

3.2.2. You may download the latest version of software from our webpage [ThorCam™ Software for Scientific and Compact USB Cameras](#). Choose the appropriate installation format, 32-bit or 64-bit and download the file to your host computer. You cannot install the 32-bit version on a 64-bit computer. Double-click the file to run the installation.

Software Designer Kits (SDKs) for Windows and Linux are also available at the same download page.

3.2.3. Driver Selection

Your camera requires a driver to be installed on your computer. After the welcome screen, acceptance of the license agreement, and entering your user information, you will be presented with a choice of drivers. Select the driver that matches the interface on your camera, in this case USB3.0. Thorlabs offers various cameras with Gigabit Ethernet or Camera Link interfaces. If you have more than one camera, and they have different interfaces, select all that apply. If you're unsure, select them all.

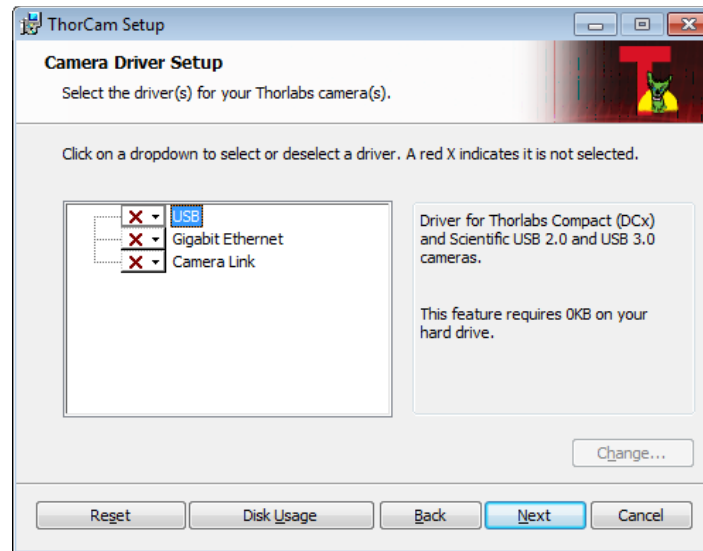

Select a driver for installation by clicking on the dropdown arrow and selecting either of the two choices; “This feature will be installed on local hard drive,” or “This feature, and all sub-features, will be installed on local hard drive.” There are no sub-features, so both choices do the same thing.

ALL Cooled sCMOS series cameras must have the USB driver selected.

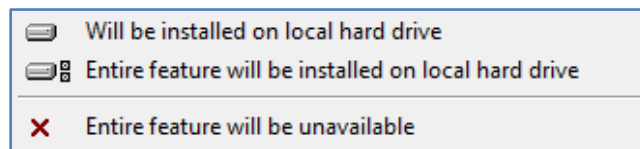

Once a driver is selected, the red X will be replaced with a hard drive icon as shown in the USB selection below.

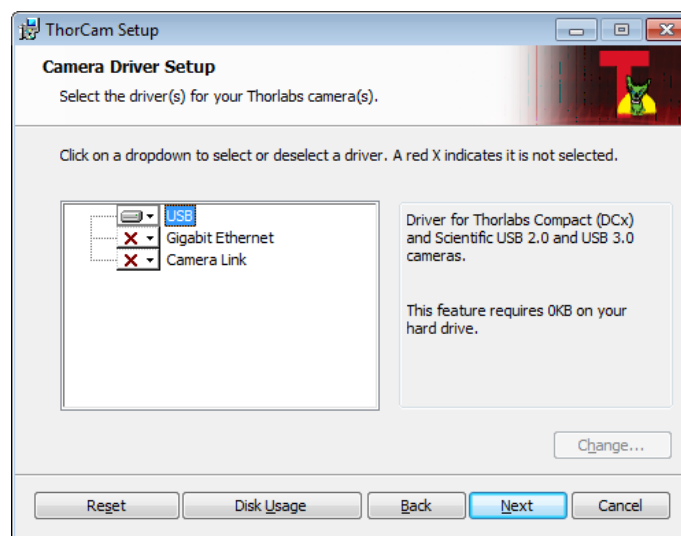

Click Next to proceed with the driver installation. Depending on your PC's configuration and the drivers you selected, you might encounter the additional Windows security dialogs below. Be sure to click "install" to complete the operation, otherwise the installer will "roll back" and exit.

USB Driver Installation. Click "Install". This is required for Cooled sCMOS series cameras.

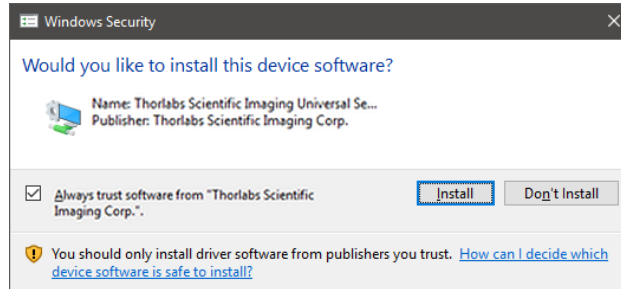

Gigabit Ethernet Driver Installation. This is not required for Cooled sCMOS series cameras, but if you have Thorlabs "GE" cameras it is recommended. If so, click "Install".

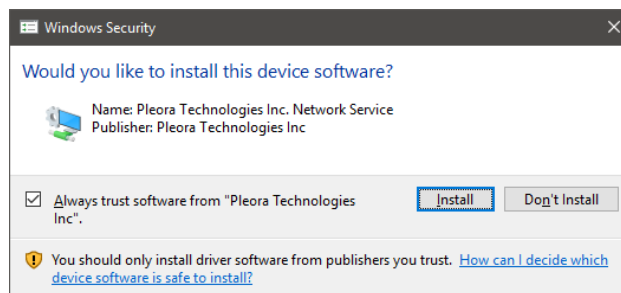

Once setup is complete, you may now proceed to the next section that will describe how to connect and power on your camera. When the camera is connected and powered up, you can navigate to the ThorCam Imaging Software as shown below:

“Start” → “All Programs” → “Thorlabs” → “ThorCam”

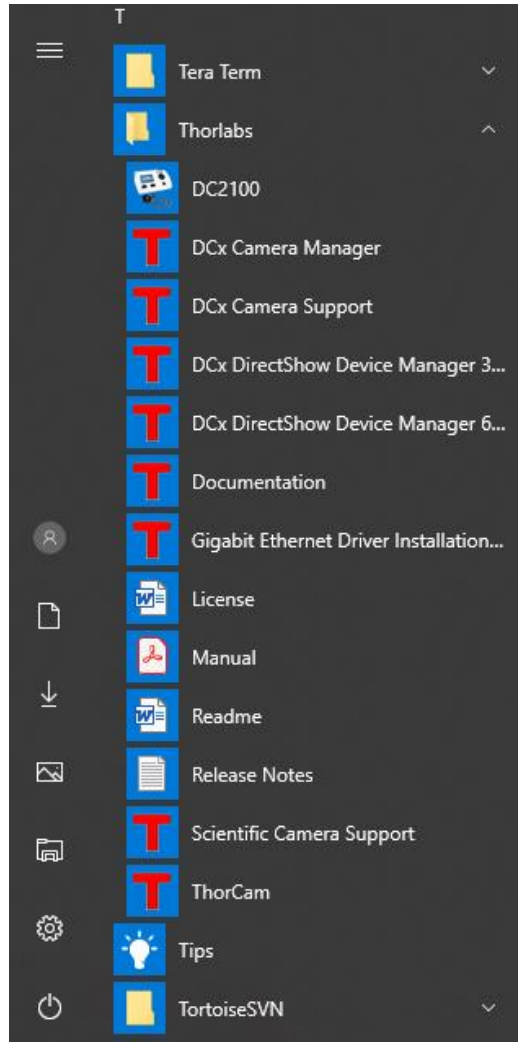

Or simply double-click on the ThorCam shortcut icon that was placed on your desktop during installation of the software:



3.2.4. Installing 3rd Party Software Application Support

After installation of Thorlabs components is complete, you have access to interfaces for select 3rd-party image analysis packages you may already have installed on your computer, such as MATLAB®.

3rd-party application software interfaces are located in Zip files in the following directory:

C:\Program Files\Thorlabs\Scientific Imaging\Scientific Camera Support

Important: Do not develop 3rd-party solutions in this directory, as they will be deleted if you update your ThorCam software.

To use the MATLAB and LabVIEW interfaces, extract from the Zip file and place in the appropriate directory on your system.

Special note for users of Micro-Manager (μ Manager) software: support for Thorlabs scientific cameras (excluding the CS505MUP polarization camera) is included when you run versions 1.4.14 and later. If you wish to download or update your Micro-Manager software, please visit

https://micro-manager.org/wiki/Micro-Manager_Open_Source_Microscopy_Software

Before using your camera within Micro-Manager, first make sure that your camera is properly installed and powered-on. You may run a session of ThorCam to confirm that the camera, software and drivers are properly installed. Then, shut down your ThorCam session and start a Micro-Manager session.

3.3. Connecting the Camera



Figure 1 Rear Panel Connections

To connect the camera, follow the steps below.

1. Connect the provided USB 3.0 cable¹ into the mating **USB 3.0** port on the back of the camera. The camera end of the cable will have two thumb screws. Make sure the connector is fully inserted, and then tighten the thumbscrews by hand into the camera housing.
2. Connect the provided +5V / 3A power supply to the **TEC Power** port by threading the mating connector onto the camera's connector.
3. Connect the other end of the USB 3.0 cable into a USB 3.0 port (USB SS) on the host computer. Note: The camera will turn on at this point.
4. If external I/O signaling is required connect an 8050-CAB1 cable (not included) to the I/O port. See section 3.7.
5. Confirm that the appropriate AC Mains adapter is installed on the +5V / 3A power supply, then plug it into a suitable AC Mains power source of 100 – 240 VAC @ 50 – 60 Hz. See section 2.3.1.



Figure 2 TEC Power Supply and Mains Adapters

Note 1 - All cameras are supplied with one USB 3.0 cable. These cables are constructed to provide reliable data throughput at a length of 3 m. Do not replace this cable with a 3 m cable from a different vendor. The use of a shorter cable (1 m or 2 m) may be acceptable but is not guaranteed. Never use any cable that is longer than 3 m on a USB 3.0 system.

3.3.1. Multiple Camera Operation

If multiple camera operation is required on the same computer, it is recommended that each camera uses a dedicated USB 3.0 port. Do not use a USB 3.0 hub.

3.4. Optical and Mechanical Mounting Considerations

3.4.1. Using a C-Mount Lens

For the best results, the use of a C-mount lens that matches the optical format of the sensor's imaging area is recommended (refer to the sensor specifications starting at Chapter 5). For more information on Thorlabs C-Mount lenses, please visit www.thorlabs.com.

C-mount lenses are specified with a flange focal distance of 17.5 mm in free air. However, there can be considerable variation in the flange focal distance among commercially available lenses, as well as effects due to inline optics.

To accommodate for these variations the camera has a fixed flange distance of 18.0 mm to allow you to bring objects at infinity in focus *before* the infinity stop on the lens is reached.

3.4.2. Mounting the Camera

On most commercial microscopes, the use of a suitable adapter is recommended in order to match the optical format of the imaging area. Please note that some commercial 1X adapters may under fill the imaging area, leading to vignetting of the image.

Six 1/4"-20 tapped holes are provided, one or two on each side of the housing. These may be used with tripods or other optical mounting devices. These 1/4"-20 tapped holes are compatible with Thorlabs Ø1" posts. For more information on Thorlabs Ø1" posts, please visit www.thorlabs.com.

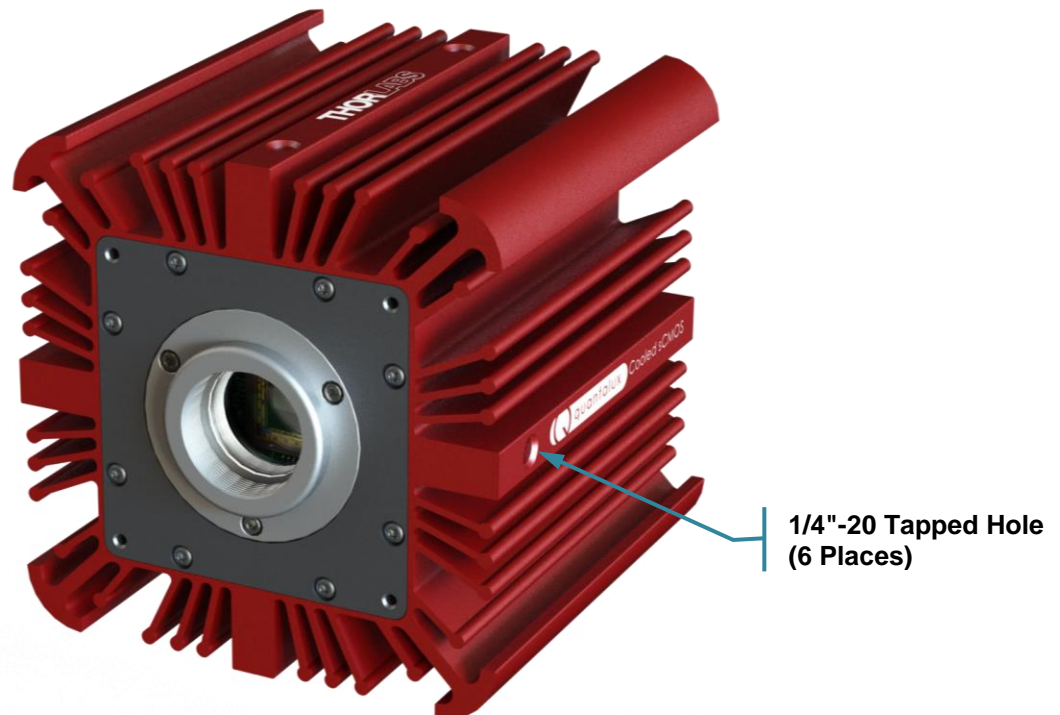

Figure 3 Arrow Indicates One of the Six 1/4"-20 Tapped Holes on Camera

3.4.3. Using the Camera with a Cage System

The cameras have 4-40 tapped holes on the front face for compatibility with Thorlabs' 60 mm Cage systems.

For more information on Thorlabs' 60 mm Cage system components, please visit www.thorlabs.com.

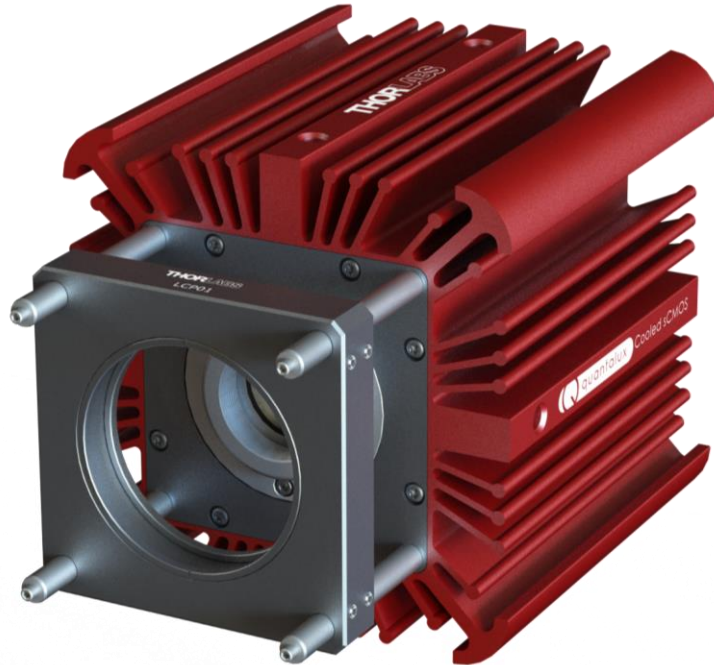

Figure 4 Camera Shown as Part of a 60 mm Thorlabs Cage System

3.5. Optical Front End

The images below show the components located on the front end of the camera.



Figure 5 Exploded View of Optical and Mechanical Components

3.5.1. Description of Components

- **C-Mount Adapter:** Allows the camera to be optically coupled with standard C-mount optics, including lenses and microscope adapters.
- **Lens Cap (Not Shown):** A protective cover that should always be installed during movement or shipment, and when the camera is not in use. The lens cap threads into the C-mount adapter.
- **Protective Window:** Unless otherwise requested, an AR coated protective glass window is installed and held in place by an **O-ring**.
 - Users may, at their discretion, remove the protective glass window, or replace it with a custom optical filter. When using the C-mount adapter the maximum filter thickness is 0.079" (2.0 mm) with Ø1" (25 mm).
 - All monochrome cooled scientific cameras are configured with a clear, broadband, AR-coated protective window to preserve the entire sensor spectral response. If the image spectrum must be limited, for example to eliminate unwanted near-infrared light, Thorlabs offers a wide range of high-quality interference and colored-glass filters compatible with the camera.
 - See Chapter 8 for more information on the clear glass window. See Section 3.6.1 for instructions related to removing and replacing the glass window.

3.6. Optical Front End Procedures

3.6.1. Window Removal and Replacement Procedure

TSI cooled scientific cameras have a protective clear glass window installed (See Section 3.5.1). The window has a broadband anti-reflection coating that is easily scratched or smudged by oil from fingers. Use soft, clean cotton, latex, or nitrile gloves and handle the window by the edges.

The optical front end is designed to accommodate standard $\text{Ø}1"$ windows. Users can, at their discretion, operate the camera without any glass installed or install custom filters in front of the sensor. The maximum filter thickness when using the C-mount adapter is 0.079" (2.0 mm). See Chapter 8 for more information.

Note: If no glass is installed, dust and debris may collect on the hermetic chamber window. Care must be taken when cleaning this window to avoid scratching or other damage to the glass. Please use every precaution to avoid contact with the hermetic chamber window, and to keep the camera securely mounted to the optical system or capped when not in use.

Removal of the Protective Window from the Camera

1. Using the hex key provided, remove the three socket head screws from the C-mount adapter.
2. You can now lift the C-mount adapter out of the camera housing.
3. Locate the pry slot along the perimeter of the rubber O-ring that is holding the protective window in the adapter. Using a non-metallic tool (optic safe tweezers or equivalent) pry the O-ring out of the C-mount adapter. Use caution to prevent the glass window from falling out of the adapter.

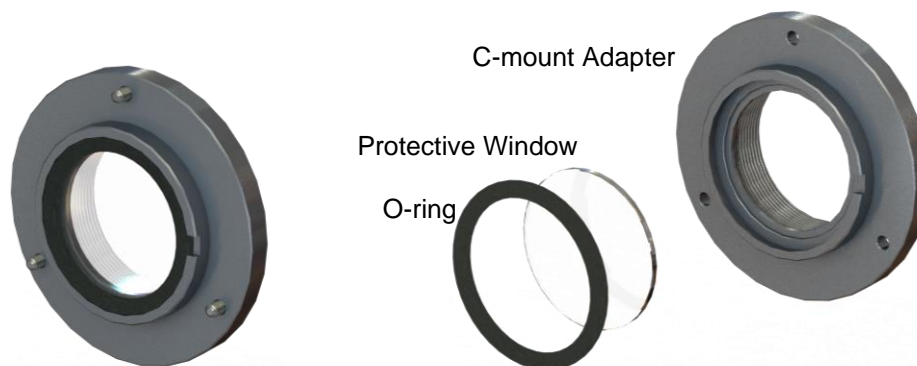

Figure 6 Removing the Window

4. Carefully remove the window from the C-mount adapter and place it in a safe location.

3.6.2. Re-Assembly of the Window and C-Mount Adapter and Flange Focus Adjustment

1. Replacement of the window and C-mount adapter is done in the reverse order as shown in Section 3.6.1. **Care must be taken when handling the window.**
2. The O-ring used to secure the window in the adapter must be pressed firmly into the mating groove in the adapter until both the O-ring and the window are held securely in place.
3. Clean the window prior to reinstalling the C-mount adapter into the camera.
4. Install a compatible lens. There is no further adjustment required as the C-mount adapter has a fixed flange focal distance.

3.7. Auxiliary Connector

The auxiliary connector on the camera allows the user to access optional camera control and internal status signals.

3.7.1. Pin Descriptions

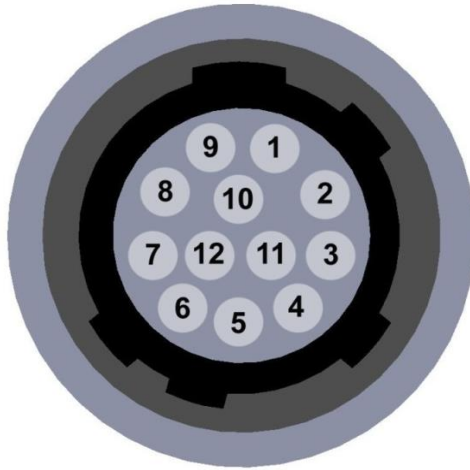

Figure 7 Illustration of the Auxiliary Connector on the Rear of the Camera

Pin Descriptions	
Pin #	Signal
1	Ground
2	Ground
3	Ground
4	LVTTL STROBE_OUT / EEP
5	LVTTL TRIGGER_IN
6	LVTTL LVAL_OUT
7	OPTO I/O_OUT STROBE
8	OPTO I/O_RTN
9	OPTO I/O_IN
10	Ground
11	Ground
12	LVTTL FVAL_OUT

3.7.2. Signal Descriptions

- **Pins 1, 2, 3, 10, 11:** Ground. This is the electrical ground for the camera TTL signals.
- **Pin 4, STROBE_OUT (Output):** STROBE_OUT is an LVTTL output that is high during the actual sensor exposure time when in continuous, overlapped exposure mode. STROBE_OUT is typically used to synchronize an external flash lamp or other device with the camera.
- **Pin 4 EEP Alternate Function (Output – CC215MU Only):** EEP - Equal-Exposure Pulse is available when Equal-Exposure Pulse is selected in the ThorCam Settings Dialog or by other means. This signal is active from the time when rolling reset is complete to the time when rolling readout commences. The Equal Exposure Pulse is typically used to synchronize an external flash lamp or other device with the camera in order to produce uniform exposures across the entire ROI. See Section 0.
- **Pin 5 TRIGGER_IN (Input):** TRIGGER_IN is an LVTTL input used to trigger exposures on the camera. Transitions can occur from the HIGH to LOW states or LOW to HIGH, as selected using the ThorCam interface. Default is Low to High. Minimum Trigger Pulse-width is 100 μ s.
- **Pin 6, LVAL_OUT (Output):** LVAL_OUT refers to “Line Valid Output.” It is an active-HIGH LVTTL signal and is asserted during the valid pixel period on each line. It returns low during the inter-line period between each line and during the inter-frame period between each frame.
- **Pin 7, OPTO I/O_OUT (Output):** The OPTO I/O_OUT signal is an optically isolated output signal. The user must provide a pull-up resistor to an external voltage source of 2.5 V to 20 V. The pull-up resistor must limit the current into this pin to <40 mA. The default signal present on Pin 7 is the STROBE_OUT signal, which is effectively the Trigger Out signal as well. Note: The value of the user supplied pull-up resistor affects the rise and fall time of this output.
- **Pin 8, OPTO I/O_RTN:** This is the return connection for the OPTO I/O_OUT output and the OPTO I/O_IN input connections. This must be connected to the pull-up source for OPTO I/O_OUT or the driving source for the OPTO I/O_IN signals.

- **Pin 9, OPTO I/O_IN (Input):** The OPTO I/O_IN signal is an optically isolated input signal used to trigger an exposure event. The user must provide a driving source from 3.3 V to 10 V. An internal series resistor limits the current into this pin to <math><50\text{ mA}</math> @ 10 V. Minimum Trigger Pulse-width is 100 μs .
- **Pin 12, FVAL_OUT (Output):** FVAL_OUT refers to “Frame Valid Output” and is an LVTTTL output that is HIGH during active readout lines. FVAL_OUT remains high throughout the active readout and returns low between frames.

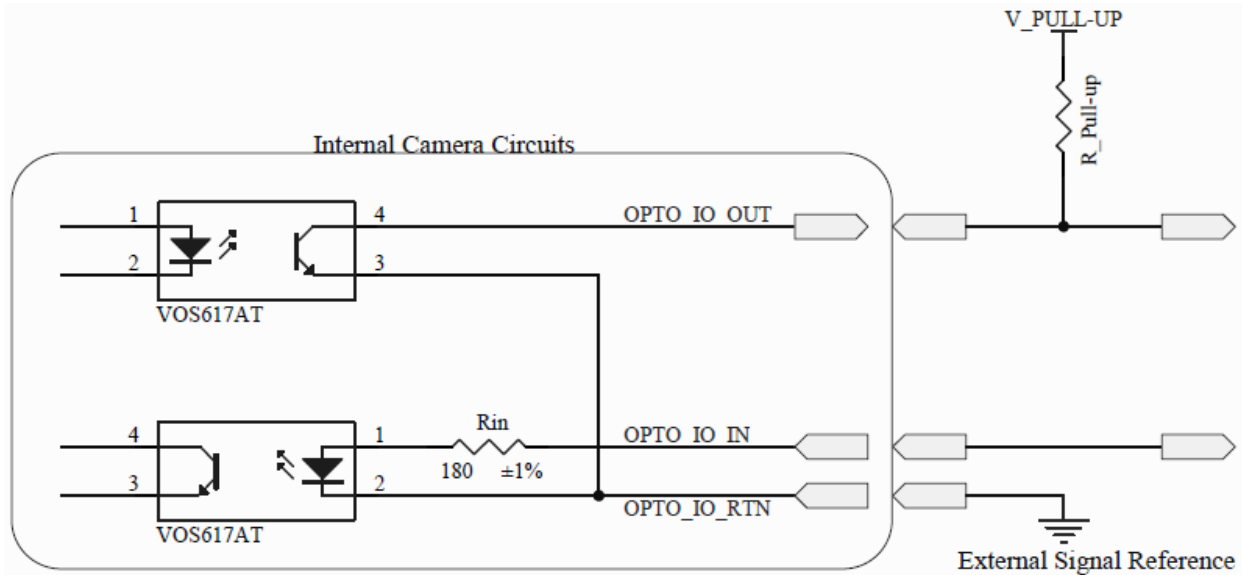

Figure 8 Internal Opto-Isolated I/O Circuits

3.7.3. Auxiliary I/O Cable Requirements

An auxiliary I/O cable may be fabricated in order to connect to the AUX I/O port of the camera. This cable is application specific in all cases due to varying lengths and functions that are used. If an Auxiliary I/O cable is to be used with this camera it must be constructed using shielded cabling for the camera to adhere to CE and FCC compliance. Lengths greater than 10 feet (3 m) have not been evaluated for EMC compliance. The mating connector for the rear panel connector is **HIROSE HR10-10P-12P (73)**.

A 10-foot-long (3 m) auxiliary I/O cable and interconnect break-out board are available from Thorlabs allowing access to some of the I/O control functions (LVTTTL_Trigger_In, LVTTTL_LVAL_Out, LVTTTL_FVAL_Out, and LVTTTL_Strobe_Out). OPTO I/O_OUT, OPTO I/O_RTN, and OPTO I/O_IN are not supported. Order the “8050-CAB1” and the “TSI-IOBOB” or “TSI-IOBOB2”, as well as the required number and style of SMA patch cables for your specific application. Order the CA28xx SMA-to-BNC series (e.g. CA2848 for 48” cable) or the CA29xx SMA-to-SMA series (CA2948 for 48” cable) as needed.

Chapter 4 Operation

The cooled scientific cameras can be operated using the ThorCam Imaging Software. For more details on using ThorCam please consult the ThorCam User Manual.

4.1. Starting the Camera

With the camera software installed and the camera connected as instructed (Refer to Section 3.3), the Status LED should light up solid Yellow, turning to solid Blue several seconds after power is applied. The table below details the conditions represented by the status indicator.

LED	If LED is Flashing	If LED is On	If LED is Off
Status	USB port cannot provide sufficient power to the camera	Blue: Connected to a USB 3.0 Port Green: Connected to a USB 2.0 Port Yellow: Camera has internal problem ¹ Cyan: TEC Power Supply is not connected or turned on.	There is no USB Connection providing power to the camera

Note 1 – The Status LED will be yellow momentarily at power up while the camera initializes.

If you are using the ThorCam Image Acquisition Software please refer to the ThorCam User Guide, which can be accessed in the Documentation selection under the Start menu / All Programs listing for Thorlabs' products.

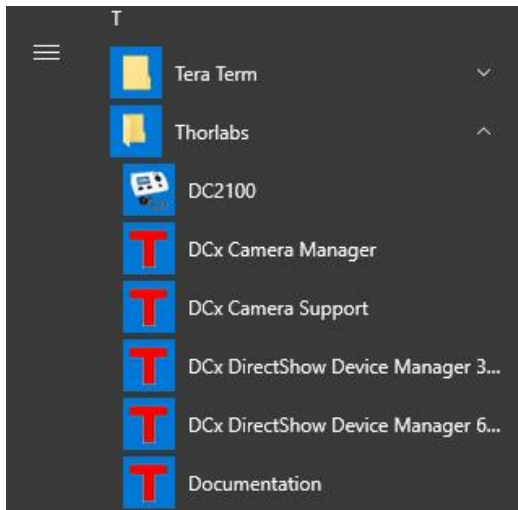

4.2. Camera Timing Diagrams

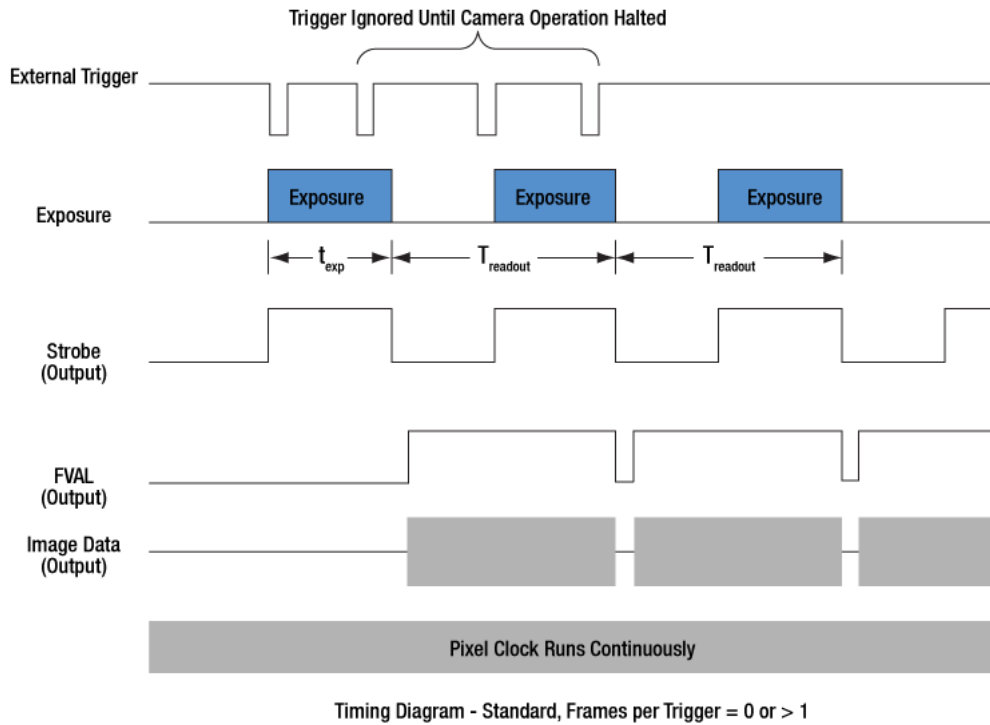

Figure 9 Timing Diagram – Standard, Frames per Trigger = 0 or > 1

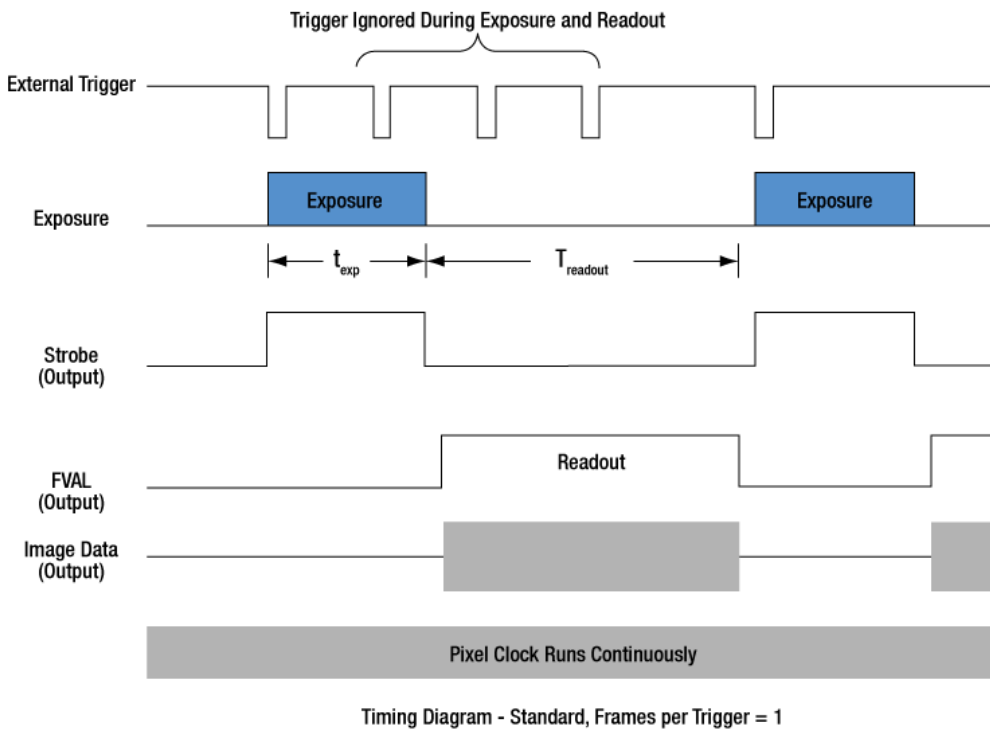

Figure 10 Timing Diagram – Standard, Frames per Trigger = 1

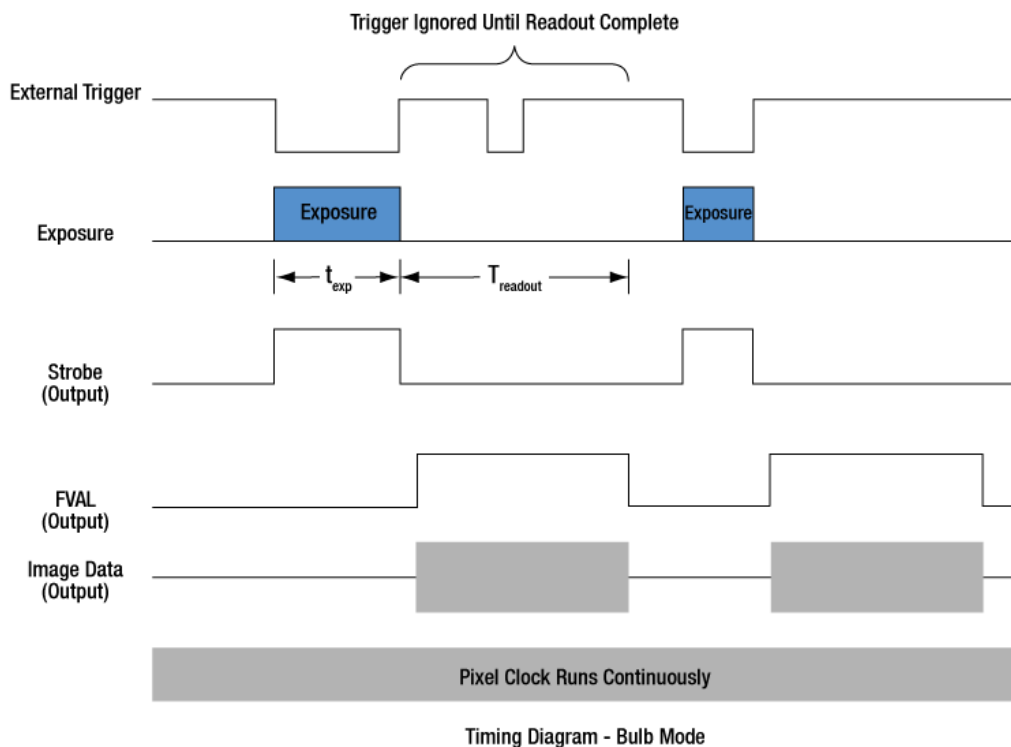

Figure 11 **Timing Diagram – Bulb Mode**

4.2.1. Camera-Specific Timing Considerations

Due to the general operation of our Kiralux CMOS sensor cameras, as well as typical system propagation delays, the timing relationships shown above are subject to the following considerations:

- 1) The delay from the external trigger to the start of the exposure and strobe signals is typically 270 ns for all triggered modes (standard and PDX/Bulb) for CC505MU cameras.
- 2) For PDX/Bulb mode triggered exposures, in addition to the start delay discussed above, there is also a fixed exposure time error AFTER the falling edge of the external trigger. This is inherent in the Kiralux sensor operation. This error is 13.72 μ s on the CC505MU, and 14.26 μ s on the CC895MU.

It is important to note that the Strobe_Out signal includes the additional fixed exposure time error and therefore is a better representation of the actual exposure time. Our suggestion is to use the Strobe_Out signal to measure your exposure time and adjust your PDX mode trigger pulse accordingly.

4.3. Equal-Exposure Pulse (CC215MU Quantalux Only)

The Equal-Exposure Pulse (EEP) is an output signal available on the Quantalux Cooled sCMOS camera's I/O connector (Refer to Section 3.7). When operated from the ThorCam acquisition software, checking the Equal Exposure Pulse box in the Settings Dialog will reconfigure the Strobe_Out signal on the I/O connector to be active only after the sensor's "rolling reset" function has completed. The signal will remain active (logical high) until the sensor's "rolling readout" function begins. This means that the EEP signal is high only between the "rolling reset" and "rolling readout" intervals, when all the sensor's pixels are simultaneously integrating. If the illumination source is active only within this interval, when the EEP signal is high, the resulting image will not show an exposure gradient typical of rolling shutter sensors.

The EEP can only be produced when the exposure time is greater than the rolling reset period, defined as the reciprocal of the frame rate. Exposure time, optimization rate, and ROI all determine the final frame rate, so varying combinations of all will determine when the signal can be produced.

For example, a CC215MU at full-frame ROI and a Data Rate setting of 30 fps requires an exposure setting greater than ~33.3 ms for EEP to be active. Changing the ROI to 50% also changes the minimum exposure setting for an active EEP to ~16 ms.

The EEP is primarily meant to be used to control a light source that will expose a scene for a precise duration only when all pixels are integrating charge. The user must keep in mind that the exposure setting will not be the *effective* exposure produced from the external light source. A rule of thumb would be to subtract the rolling reset period from the exposure setting to arrive at an approximate *effective* exposure time.

Using the example above, a CC215MU at full frame ROI, with a Data Rate setting of 30 fps requires an exposure setting greater than ~33.3 ms for EEP to be active. If you set the exposure time in the Setting window to 43.3 ms, your *effective* exposure as a result of using an external light source driven from the EEP would be ~10 ms.

The ThorCam acquisition software provides an intuitive interface for setting your desired exposure *pulse time* without having to worry about the impact of the other parameters, including the overall exposure time. ThorCam allows a minimum pulse width of 1 ms, with increments of 0.1 ms.

Be aware that the EEP has no bearing on continuously illuminated scenes, and the resulting exposure and timing relationship will be that of a normal acquisition.

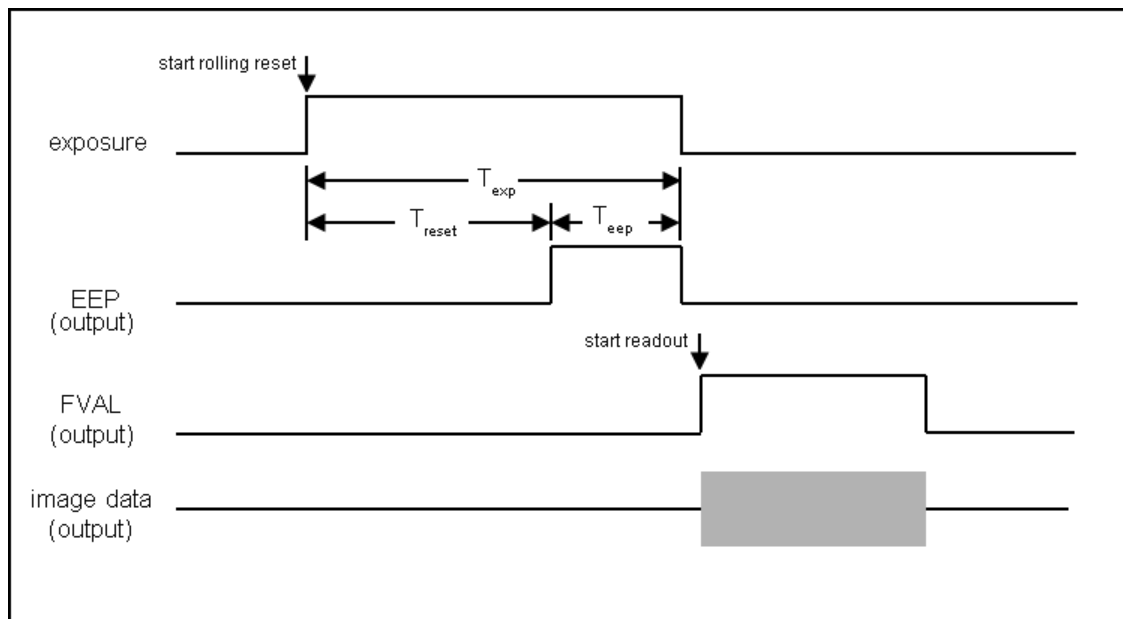

Figure 12 Timing Diagram – Equal-Exposure Pulse

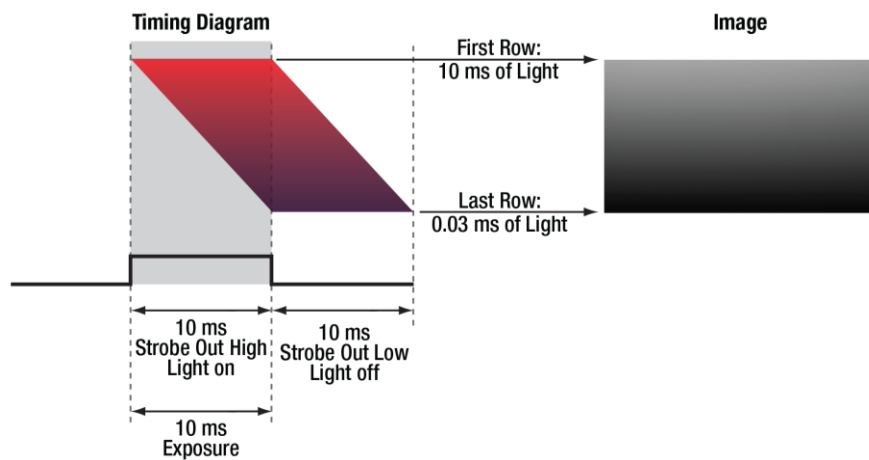

Figure 13 Timing Diagram – Strobe Driven Exposure

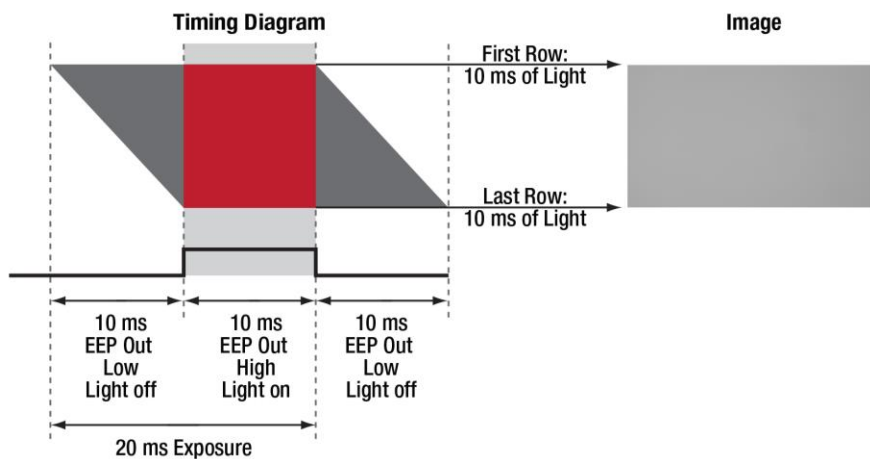

Figure 14 Timing Diagram – EEP Driven Exposure

4.4. Hot Pixel Correction

Hot Pixel Correction is a firmware function that identifies and corrects pixels that are much brighter than their surrounding pixels. Typically visible as very bright pixels regardless of the scene being imaged, these are unavoidable by-products of the CMOS and sCMOS sensor manufacturing process.

This feature can be activated by checking the **Hot Pixel Correction** check box in the ThorCam acquisition software Settings Dialog. The **Threshold** can then be adjusted using the adjacent slider or the numeric input box. The Hot Pixel Correction box can only be checked and unchecked when the camera is stopped. Once it is checked however, the Threshold adjustment can be made on a live image.

A hot pixel is identified by comparing with the mean value of the surrounding 8 pixels out of a 3x3 neighborhood. If the difference between the pixel value and the mean is larger than a specified threshold value, then this pixel is considered a hot pixel and will be replaced with the median value of those pixels in the neighborhood. As the slider is moved towards “Aggressive,” the threshold is reduced in a linear fashion. The minimum threshold value, corresponding to the upper limit, has been selected to provide users with the ability to correct hot pixels having a deviation of only a few hundred counts. At this most aggressive value, it is quite likely that image signal near the maximum pixel values (full scale) will be altered by the Hot Pixel Correction algorithm, so care must be taken at the most aggressive levels. This correction is done in hardware and any images saved by the host application will only have corrected data.

This feature is available on all Quantalux models.

Chapter 5 CC215MU Specifications

5.1. sCMOS Sensor Specifications

Sensor Specifications	
Sensor Type	sCMOS Monochrome
Number of Active Pixels	1920 (H) x 1080 (V) (~2.07 MP)
Pixel Size	5.04 μm x 5.04 μm
Optical Format	2/3" Format (9676.8 μm x 5443.2 μm)
Peak Quantum Efficiency	61% at 600 nm
Dynamic Range	Up to 87 dB
Full Well Capacity	$\geq 23,000 e^-$
Shutter Type	Rolling

5.2. Quantum Efficiency

CC215MU Quantum Efficiency

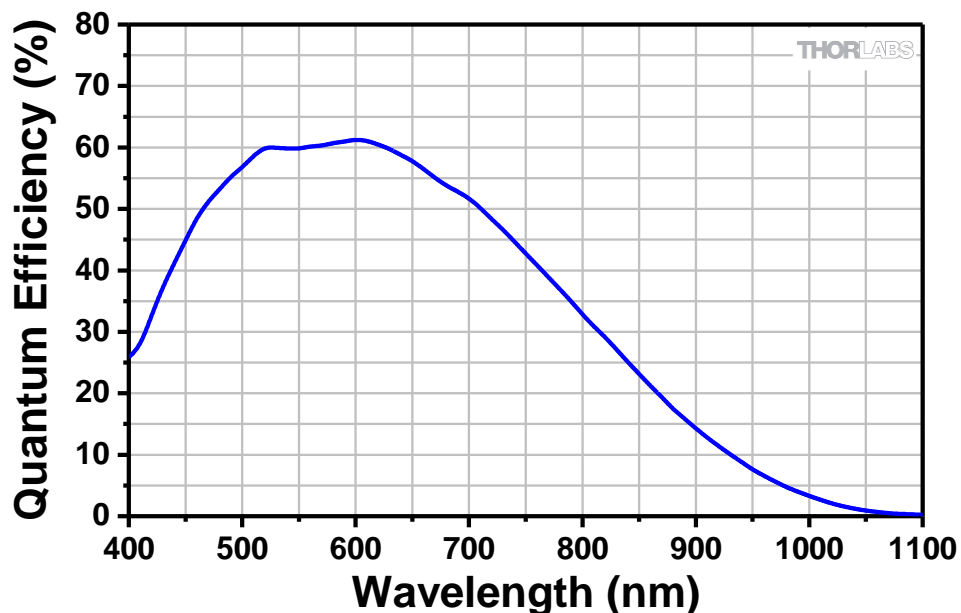

5.3. Imaging Specifications

Imaging Specifications	
Exposure Time	0.029 to 7767.2 ms in ~0.03 ms Increments
Pixel Clock Speed	74.25 MHz and 148.5 MHz
ADC Resolution	16 Bits
Vertical and Horizontal Hardware Binning	1 x 1 to 16 x 16
Region of Interest (Width x Height)	8 x 2 Pixels ¹ to 1920 x 1080 Pixels, Rectangular
Read Noise	$< 1 e^-$ Median RMS ² / $< 1.5 e^-$ RMS

¹ For Binning at 1 x 1.

² Per Sensor Manufacturer's Specification

5.4. Example Frame Rates

ROI	Frame Rate	
	L.R.N. ¹	H.F.R. ¹
Full Sensor (1920 x 1080)	30 fps	50 fps
Half Sensor, (960 x 540)	60 fps	100 fps
1/10th Sensor, (192 x 108)	300 fps	500 fps

~1 ms Exposure Time, 1 x 1 Binning,
 Frames per Trigger = Continuous
¹ L.R.N. is Low Read Noise and
 H.F.R. is High Frame Rate. Both are
 Optimization modes.

5.5. CC215MU Power Consumption

3.7 W Max @ 30 fps Full Sensor ROI, Camera Only, Powered from Host Computer

4.3 W Max @ 50 fps Full Sensor ROI, Camera Only, Powered from Host Computer

12.6 W Max, Cooler Power Only (using provided power supply, 100 – 240 VAC @ 50 – 60 Hz.)

5.6. Operating/Storage Temperatures

Operating: 10 °C to 40 °C (Non-condensing)

Storage: 0 °C to 55 °C

5.7. Sensor Temperatures in Cooling Mode

Operating Ambient Temperature: 10 °C to 40 °C

Sensor Temperature: -10 °C to 20 °C

Chapter 6 CC505MU Specifications

6.1. CMOS Sensor Specifications

Sensor Specifications	
Sensor Type	CMOS Monochrome
Number of Active Pixels	2448 (H) x 2048 (V) (~5.01 MP)
Pixel Size	3.45 μm x 3.45 μm
Optical Format	2/3" Format (8445.6 μm x 7065.6 μm)
Peak Quantum Efficiency	72% Over 525 to 580 nm (Typical)
Dynamic Range	Up to 71 dB
Full Well Capacity	$\geq 10,000 e^-$
Shutter Type	Global

6.2. Quantum Efficiency

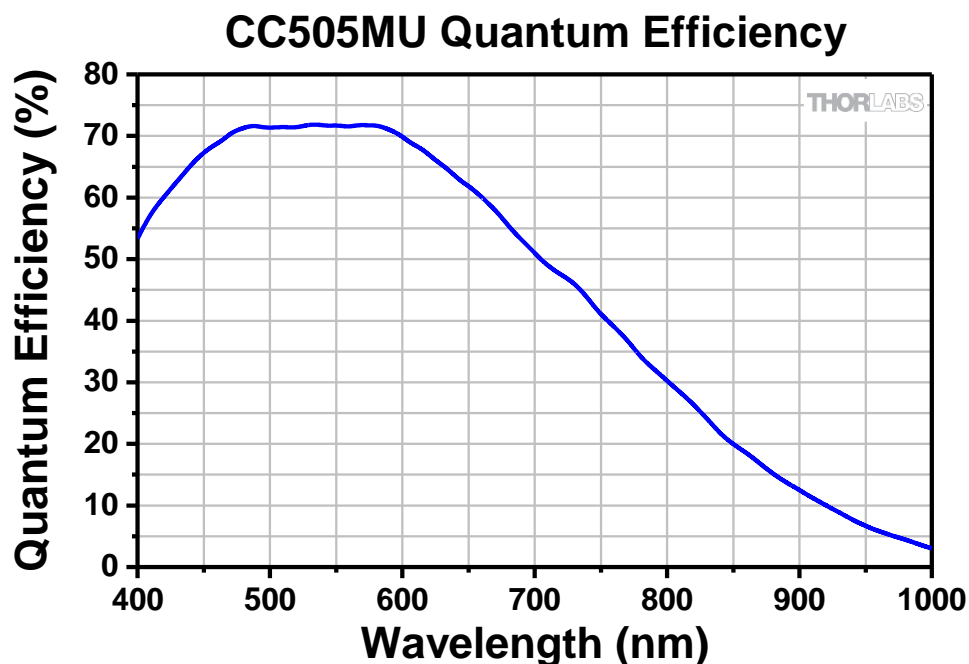

6.3. Imaging Specifications

Imaging Specifications	
Exposure Time	0.027 to 14235 ms in ~0.013 ms Increments
ADC Resolution	12 Bits
Vertical and Horizontal Hardware Binning	1 x 1 to 16 x 16
Region of Interest (Width x Height) (For Binning at 1 x 1)	260 x 4 Pixels to 2448 x 2048 Pixels, Rectangular
Read Noise	$< 2.5 e^-$ RMS
Overlapped Exposures	Frames per Trigger = Continuous Only

6.4. Example Frame Rates

ROI	Frame Rate
Full Sensor (2448 x 2048)	35 fps
Half Sensor (1224 x 1024)	68 fps
~1/10th Sensor (260 x 208)	290 fps
Min ROI (260 x 4)	887.6 fps

~1 ms Exposure Time, 1 x 1 Binning,
Frames per Trigger = Continuous

6.5. CC505MU Power Consumption

3.6 W Max @ 35 fps Full Sensor ROI, Camera Only, Powered from Host Computer

12.6 W Max, Cooler Power Only (using provided power supply, 100 – 240 VAC @ 50 – 60 Hz.)

6.6. Operating/Storage Temperatures

Operating: 10 °C to 40 °C (Non-condensing)

Storage: 0 °C to 55 °C

6.7. Sensor Temperatures in Cooling Mode

Operating Ambient Temperature: 10 °C to 40 °C

Sensor Temperature: -10 °C to 20 °C

Chapter 7 CC895MU Specifications

7.1. CMOS Sensor Specifications

Sensor Specifications	
Sensor Type	CMOS Monochrome
Number of Active Pixels	4096 (H) x 2160 (V) (~8.9 MP)
Pixel Size	3.45 μm x 3.45 μm
Optical Format	1" Format (14131 μm x 7452 μm)
Peak Quantum Efficiency	72% Over 525 to 580 nm (Typical)
Dynamic Range	Up to 71 dB
Full Well Capacity	$\geq 10,650 e^-$
Shutter Type	Global

7.2. Quantum Efficiency

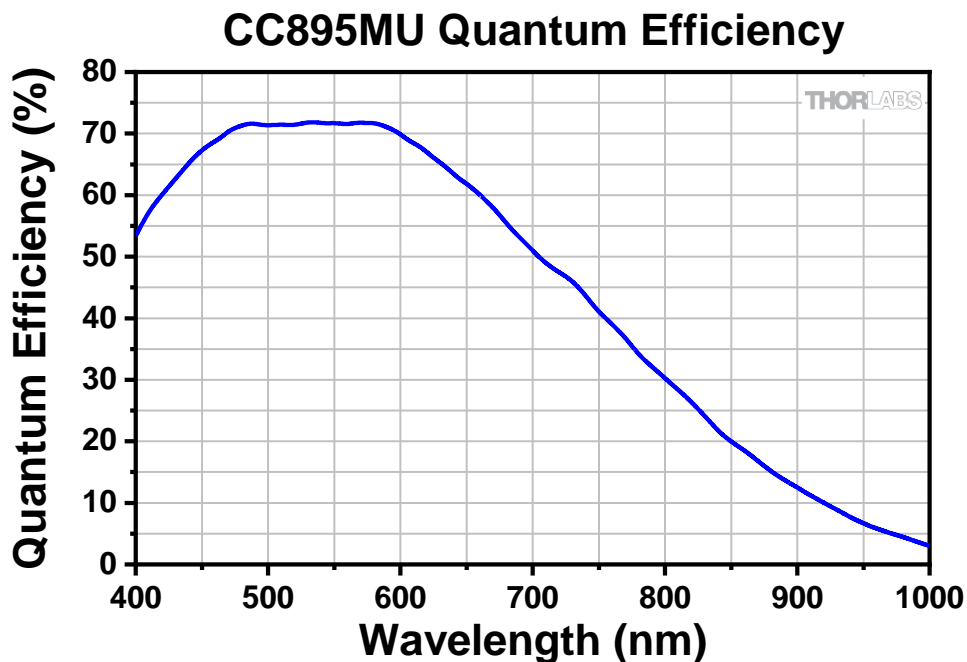

7.3. Imaging Specifications

Imaging Specifications	
Exposure Time	0.036 to 22795 ms in ~0.022 ms Increments
ADC Resolution	12 Bits
Vertical and Horizontal Hardware Binning	1 x 1 to 16 x 16
Region of Interest (Width x Height) (For Binning 1 x 1)	260 x 4 Pixels to 4096 x 2160 Pixels, Rectangular
Read Noise	$< 2.5 e^-$ RMS
Overlapped Exposures	Frames per Trigger = Continuous Only

7.4. Example Frame Rates

ROI	Frame Rate
Full Sensor (4096 x 2160)	20.8 fps
Half Sensor (2048 x 1080)	40.8 fps
~1/10th Sensor (410 x 216)	175.4 fps
Min ROI (260 x 4)	922 fps

~1 ms Exposure Time, 1 x 1 Binning,
Frames per Trigger = Continuous

7.5. Operating/Storage Temperatures

Operating: 10 °C to 40 °C (Non-condensing)

Storage: 0 °C to 55 °C

7.6. CC895MU Power Consumption

3.7 W Max @ 20.8 fps Full Sensor ROI, Camera Only, Powered from Host Computer

12.6 W Max, Cooler Power Only (using provided power supply, 100 – 240 VAC @ 50 – 60 Hz.)

7.7. Operating/Storage Temperatures

Operating: 10 °C to 40 °C (Non-condensing)

Storage: 0 °C to 55 °C

7.8. Sensor Temperatures in Cooling Mode

Operating Ambient Temperature: 10 °C to 40 °C

Sensor Temperature: -5 °C to 25 °C

Chapter 8 Protective Glass Window

The protective glass window is an AR (anti-reflective) coated window for monochrome cameras.

8.1. Protective Glass Window Dimensions

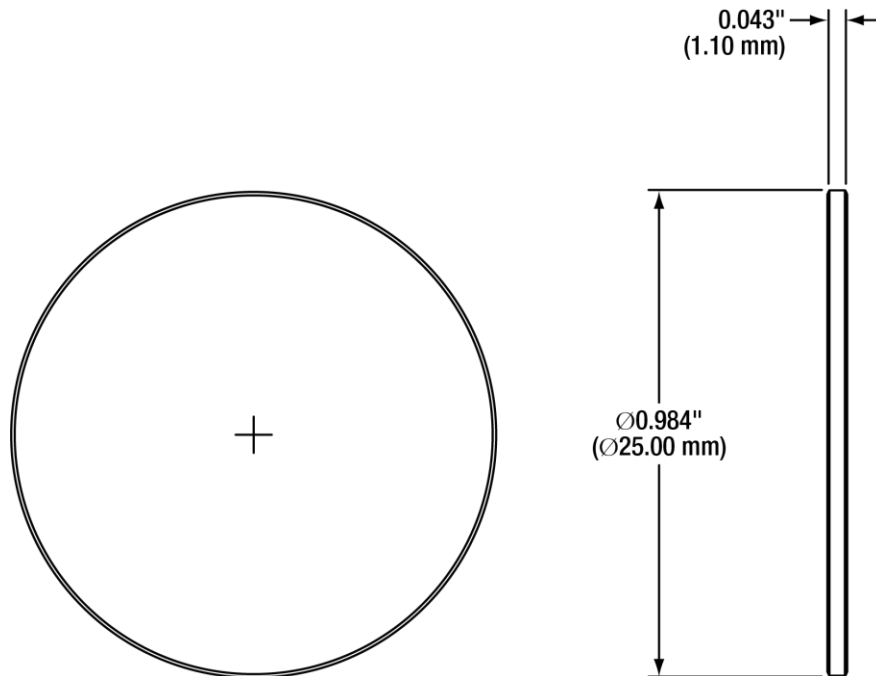

Figure 15 Protective Window Dimensions

8.2. AR-Coated Window Specifications

The AR coating has $R_{avg} < 0.5\%$ per surface over the 400 – 700 nm wavelength range.

Chapter 9 Mechanical Drawings

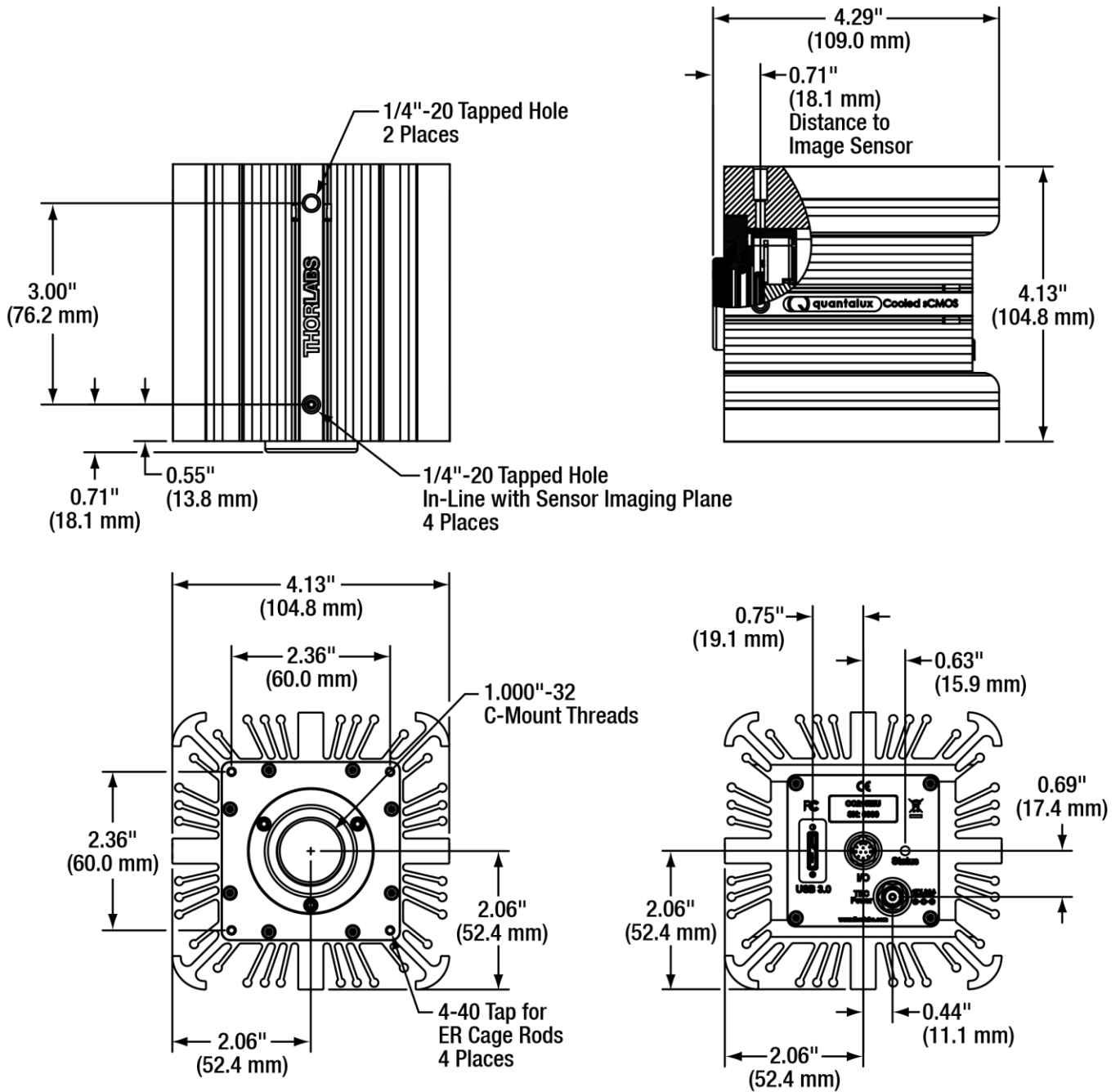

Figure 16 Cooled Scientific Camera Dimensions

Chapter 10 Troubleshooting

10.1. Interface

Problem	Symptoms	Possible Cause	Remedy
Software cannot find a connected camera	<ul style="list-style-type: none"> Software does not display a connected camera. Software does not display an image. 	1. No power to camera.	1. Connect camera to USB 3.0 Port.
		2. Camera has yet to complete "enumeration".	2. Restart/refresh software after camera has been powered on and connected to host PC for at least 30 seconds.
		3. USB 3.0 camera not connected to USB 3.0 Port or has not enumerated properly.	3. See Section 4.1. Disconnect USB 3.0 cable and then reconnect. First time connections to a PC may take longer to enumerate and load drivers.

10.2. Optical

Problem	Symptoms	Possible Cause	Remedy
When using a standard C-mount lens (not included), image is not in focus	<ul style="list-style-type: none"> Displayed image is not in focus. 	Lens is not to spec.	Replace lens.
Displayed image has spots or has debris in image	<ul style="list-style-type: none"> Debris in displayed image. 	Protective window has particulates on it.	Carefully clean the window. See Section 3.6 and Section 11.1.

10.3. Operational

Problem	Symptoms	Possible Cause	Remedy
Camera excessively warm (too hot to safely hold with ungloved hand)	<ul style="list-style-type: none"> Camera is too hot to hold with an ungloved hand. Poor image quality. 	1. Camera is not properly ventilated.	1. Remove any obstructions or provide adequate ventilation around camera.
		2. Electronics failure.	2. Disconnect camera from USB3 port and contact customer service.
Imaging Software “times out” without acquiring image	<ul style="list-style-type: none"> Imaging software indicates timeout. No images acquired – no frame count provided. 	1. Camera is not powered.	1. See Section 10.1 Troubleshooting above.
		2. Camera is not connected to computer.	2. See Section 10.1 Troubleshooting above.
		3. Imaging software is not configured to camera.	3. Consult the ThorCam User Guide.
		4. Camera is not “armed” and “started” properly.	4. Refer to Section 4.1.
Low Bandwidth USB 3.0 connection	<ul style="list-style-type: none"> Excessive dropped frames Inconsistent operation 	1. Low bandwidth USB 3.0 port.	1. Use a PCIe high bandwidth USB 3.0 Card, such as: Thorlabs’ USB3-PCIE.
		2. USB 3.0 cable is too long or poor quality.	2.a. Use the 3 m cable supplied with the camera. 2.b Use a 3 m (max) cable with 26AWG signal wires - or a 1m cable.
Yellow Status LED	<ul style="list-style-type: none"> Camera does not connect to Host 	1. Windows power saving settings.	1. Turn off all USB3.0 power saving settings in Device Manager.
Cooler Not Working	<ul style="list-style-type: none"> Status LED is Cyan ThorCam shows a status error 	1. TEC power supply is not connected to camera. 2. TEC power supply is not plugged into AC source.	1. Connect the power supply to the camera. See Chapter 3. 2. Plug the power supply into an appropriate AC mains outlet.

10.4. Software

Problem	Symptoms	Possible Cause	Remedy
Camera not found	<ul style="list-style-type: none"> Error message, or camera does not show up in Hardware Connections. 	1. Power not on.	1. Make sure camera is connected to USB3 Port.
		2. Not plugged in.	2. Make sure camera is connected to USB3 Port.
		3. Bad USB cable or connection.	3. Try a different cable. Refer to Section 4.1 for information on the camera’s status indicators.
Insufficient illumination	<ul style="list-style-type: none"> Images are all black. 	1. Exposure time too low.	1. Make sure that exposure time is greater than 0; if the exposure is already greater than 0, try increasing the exposure time or gain gradually.
		2. No light going to the camera.	2. Make sure that the light source is turned on, and that the aperture of the lens (or other optics) is not shut.
		3. Lens Cap is Installed.	3. Remove Lens Cap.

Chapter 11 Maintenance

There are no user-serviceable parts inside the camera. Removing the rear cover of the camera without expressed authorization from TSI will void the camera warranty.

TSI scientific grade cameras are manufactured in a clean environment. Before shipping, each camera is tested to assure that it meets stringent specifications for cleanliness and quality.

11.1. Cleaning Guidelines

Frequent lens changes, especially without careful attention to contaminants, can allow debris to accumulate on the infra-red blocking filter and lens surfaces. Therefore, TSI provides the following guidelines for cleaning those components.

To minimize the need to clean the optical surfaces, do not remove the protective lens mount cap shipped with the camera until you are ready to mount the camera to the optical system.

For an informative tutorial refer to the [“Handling and Cleaning Procedures for Optical Components”](#). The following guidelines, specific to TSI cameras, are meant to be used in conjunction with the procedures described in the tutorial.

Cleaning the Lens of Optical Assembly

Please follow the lens manufacturer's recommendations for cleaning. TSI is not responsible for any damage caused to a lens or optical assembly caused by customer cleaning or misuse.

To ensure optimum image quality with any TSI camera, do not remove the protective lens-mount cap until ready to mount the camera on the application. If the camera is removed from the application, immediately replace the cap. Doing so will keep dust and other contaminants from accumulating on the optical surfaces. In addition, please note the following model-specific guidelines.

Cooled Camera Precautions

Complete removal of the C-mount adapter and Ø1" protective window will expose the hermetic chamber's sealed window and will likely cause debris to accumulate on its surface. **Extreme care should be taken to avoid completely removing the Ø1" window and exposing the chamber window unless absolutely necessary. Scratches or other evidence of contact with the chamber window may void the warranty.**

Cleaning the Ø1" AR-Coated Protective Window

The Ø1" window is visible when the lens is removed, mounted inside the C-mount adapter.

- ***What must I do before cleaning the AR-Coated Window?***

Do not remove the window from the camera.

First, remove the lens, if one is installed, and carefully examine the window in a clean location under a strong, direct light. Try to determine if the contaminants are a few dust particles, oily smudge (such as fingerprints) or both.

- ***What if the contamination is only a few dust particles?***

Use a CLEAN, DRY (preferably brand-new), camel hair lens cleaning brush (such as those used by photographers) to gently wipe the particles off the filter.

- **What if the contamination includes a smudge?**

1. Remove the camera from the optical assembly and bring the camera to a clean, dry location where it is safe to use flammable solvents (please see "Caution" below)
2. Refer to Section 3.6.1. for details on removing the C-mount adapter and Ø1" protective window.
3. Place the camera face down on a clean, dry surface to prevent particles from accumulating on the chamber's hermetic window.
4. Once the window is removed, use a CLEAN, DRY (preferably brand-new), camel hair lens cleaning brush (such as those used by photographers) to gently wipe the particles off the Ø1" window.
5. Re-examine the window after removing the dust. If a smudge is still visible, proceed by dipping a clean, lint-free cotton swab in ethyl or isopropyl alcohol. The swab should be saturated, but not dripping.
6. Carefully draw the swab once across the surface, then rotate the swab 180 degrees to expose the fresh surface and draw it across the window surface again. Be careful not to pool alcohol on the glass surface.
7. Re-examine once again and repeat the process once, if necessary.

If contamination continues to be a problem, please call Thorlabs for assistance.

Cleaning the Hermetic Chamber's Protective Window

The hermetic chamber protective window is visible when the lens, C-mount adapter, and Ø1" protective window are removed. This window forms an integral part of the hermetic seal of the chamber. It cannot be removed and should never be touched. In the case of accidental contamination or smudging please use the following guidelines.

- **What must I do before cleaning the Hermetic Chamber's Protective Window?**

First, remove the lens and Ø1" protective window. Carefully examine the chamber window in a clean location under a strong, direct light. Try to determine if the contaminants are a few dust particles, oily smudge (such as fingerprints) or both. Refer to Section 3.6.1. for details on removing the C-mount adapter and Ø1" protective window.

- **What if the contamination is only a few dust particles?**

Use a CLEAN, DRY (preferably brand-new), camel hair lens cleaning brush (such as those used by photographers) to gently wipe the particles off the filter.

- **What if the contamination includes a smudge?**

1. Remove the camera from the optical assembly and bring the camera to a clean, dry location where it is safe to use flammable solvents (please see "Caution" below).
2. Refer to Section 3.6.1. for details on removing the C-mount adapter and Ø1" protective window.
3. Place the camera face down on a clean, dry surface to prevent particles from accumulating on the chamber's hermetic window until you are ready to perform the cleaning.
4. Use a CLEAN, DRY (preferably brand-new), camel hair lens cleaning brush (such as those used by photographers) to gently wipe the particles off the chamber window.

5. Re-examine the window after removing the dust. If a smudge is still visible, proceed by dipping a clean, lint-free cotton swab in ethyl or isopropyl alcohol. The swab should be saturated, but not dripping.
6. Carefully draw the swab once across the surface, then rotate the swab 180 degrees to expose the fresh surface and draw it across the window surface again. Be careful not to pool alcohol on the glass surface.
7. Re-examine once again and repeat the process once, if necessary.

If contamination continues to be a problem, please call Thorlabs for assistance.

**CAUTION**

Ethyl and isopropyl alcohols are highly flammable! Do not use near extreme heat, arcing electrical equipment (such as space heaters) or open flame! Use only with proper ventilation. Follow all safety instructions provided by the manufacturer of the alcohol product.

Chapter 12 Regulatory

As required by the WEEE (Waste Electrical and Electronic Equipment Directive) of the European Community and the corresponding national laws, Thorlabs offers all end users in the EC the possibility to return “end of life” units without incurring disposal charges.

- This offer is valid for Thorlabs electrical and electronic equipment:
- Sold after August 13, 2005
- Marked correspondingly with the crossed out “wheelie bin” logo (see right)
- Sold to a company or institute within the EC
- Currently owned by a company or institute within the EC
- Still complete, not disassembled and not contaminated

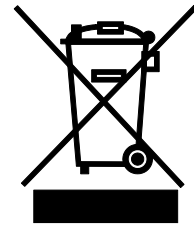

Wheelie Bin Logo

As the WEEE directive applies to self-contained operational electrical and electronic products, this end of life take back service does not refer to other Thorlabs products, such as:

- Pure OEM products, that means assemblies to be built into a unit by the user (e. g. OEM laser driver cards)
- Components
- Mechanics and optics
- Left over parts of units disassembled by the user (PCB's, housings etc.).

If you wish to return a Thorlabs unit for waste recovery, please contact Thorlabs or your nearest dealer for further information.

Waste Treatment is Your Own Responsibility





If you do not return an “end of life” unit to Thorlabs, you must hand it to a company specialized in waste recovery. Do not dispose of the unit in a litter bin or at a public waste disposal site.

Ecological Background

It is well known that WEEE pollutes the environment by releasing toxic products during decomposition. The aim of the European RoHS directive is to reduce the content of toxic substances in electronic products in the future.

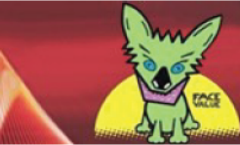
The intent of the WEEE directive is to enforce the recycling of WEEE. A controlled recycling of end of life products will thereby avoid negative impacts on the environment.

12.1. Certifications and Compliance – CE Declaration of Conformity

			
		www.thorlabs.com	
<h3>EU Declaration of Conformity</h3> <p><i>in accordance with EN ISO 17050-1:2010</i></p>			
We:	Thorlabs Inc.		
Of:	56 Sparta Avenue, Newton, New Jersey, 07860, USA		
<i>in accordance with the following Directive(s):</i>			
2014/35/EU	Low Voltage Directive (LVD)		
2014/30/EU	Electromagnetic Compatibility (EMC) Directive		
2011/65/EU	Restriction of Use of Certain Hazardous Substances (RoHS)		
<i>hereby declare that:</i>			
Model:	CC215MU, CC505MU, CC895MU		
Equipment:	Cooled Scientific Digital Camera with USB 3.0		
<i>is in conformity with the applicable requirements of the following documents:</i>			
EN 61010-1	Safety Requirements for Electrical Equipment for Measurement, Control and Laboratory Use.		2010
EN 61326-1	Electrical Equipment for Measurement, Control and Laboratory Use - EMC Requirements		2013
<i>and which, issued under the sole responsibility of Thorlabs, is in conformity with Directive 2011/65/EU of the European Parliament and of the Council of 8th June 2011 on the restriction of the use of certain hazardous substances in electrical and electronic equipment, for the reason stated below:</i>			
<i>does not contain substances in excess of the maximum concentration values tolerated by weight in homogenous materials as listed in Annex II of the Directive</i>			
<i>I hereby declare that the equipment named has been designed to comply with the relevant sections of the above referenced specifications, and complies with all applicable Essential Requirements of the Directives.</i>			
Signed:		On:	18 May 2020
Name:	Carmine Lencsak		
Position:	Chief Operating Officer	EDC -	CC215MU, CC505MU, CC895MU -2020
			

12.2. FCC Statement

This device complies with part 15 of the FCC rules. Operation is subject to the following conditions: (1) This device may not cause harmful interference, and (2) this device must accept any interference received, including interference that may cause undesired operation.

This equipment has been tested and found to comply with the limits for a Class A digital device, pursuant to part 15 of the FCC Rules. These limits are designed to provide reasonable protection against harmful interference when the equipment is operated in a commercial environment. This equipment generates, uses, and can radiate radio frequency energy and, if not installed and used in accordance with the instruction manual, may cause harmful interference to radio communications. Operation of this equipment in a residential area is likely to cause harmful interference in which case the user will be required to correct the interference at their own expense.

Modifications not expressly approved by the manufacturer could void the user's authority to operate the equipment under FCC rules.

12.3. Auxiliary I/O Cable Requirements

The Digital Camera is not supplied with a cable for connecting to the AUX I/O port of the camera. This cable is application specific in all cases due to varying lengths and functions that are used. If an Auxiliary I/O cable is to be used with this camera it must be constructed with the requirements shown in Section 3.7.3 in order for the camera to adhere to CE and FCC compliance.