

Tiberius[®] fs Laser

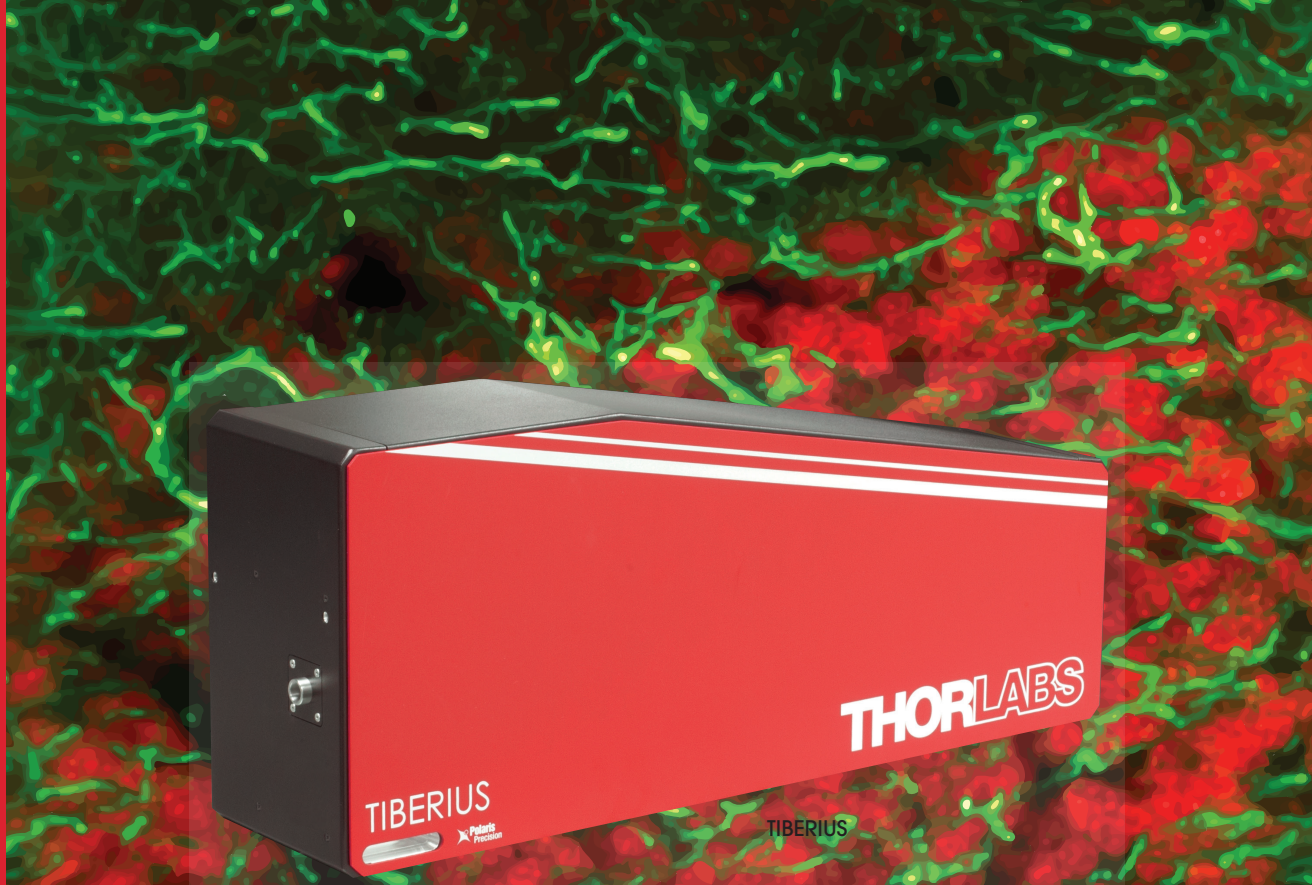

Tunable Ti:Sapphire Laser for Multiphoton Microscopy

Designed and developed in-house in collaboration with multiphoton imaging specialists, the Tiberius[®] Tunable Ti:Sapphire Laser produces ultrafast 140 fs pulses over a 720 nm to 1060 nm wavelength range. The Tiberius outputs an average power greater than 2.3 W at 800 nm and features an industry-leading tuning speed of 4000 nm/s. This tuning speed allows rapid switching between the optimal excitation wavelengths for multiple fluorophores, resulting in improved image contrast and reduced photobleaching.

The Tiberius is integrated with ThorImage[®]LS and ScanImage software, which provide seamless and synchronized control for photoactivation experiments and live high-speed imaging, as well as hands-free operation. Accessories for beam steering or dispersion management, as well as low-GDD optics, are also available.

Key Advantages

- ◆ 720 - 1060 nm Tuning Range
- ◆ 4000 nm/s Tuning Speed
- ◆ Fast Sequential Imaging
- ◆ Built-In Spectrometer
- ◆ Half the Footprint of Competing Models

THORLABS

A fs Laser Designed for Life Science Imaging

Features

- ◆ Wide Tuning Range: 720 nm to 1060 nm
- ◆ Fast Tuning Speed: Up to 4000 nm/s
- ◆ High Output Power: >2.3 W at 800 nm
- ◆ Ultrafast 140 fs Pulses Help Minimize Pulse Broadening

Applications

- ◆ Two-Photon Microscopy
- ◆ Photostimulation and Uncaging
- ◆ Label-Free Imaging via Multiphoton Autofluorescence and Second Harmonic Generation
- ◆ Fast Sequential Imaging

Typical Tuning Curve for the Tiberius Laser

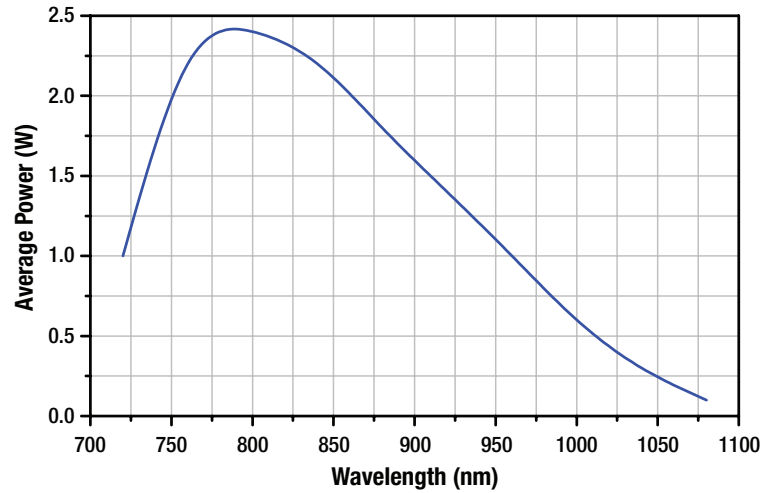

The Tiberius® Femtosecond Tunable Ti:Sapphire Laser was designed in close collaboration with Thorlabs' life science application specialists. Manufactured in-house, it leverages our extensive expertise in optical design and precision manufacturing.

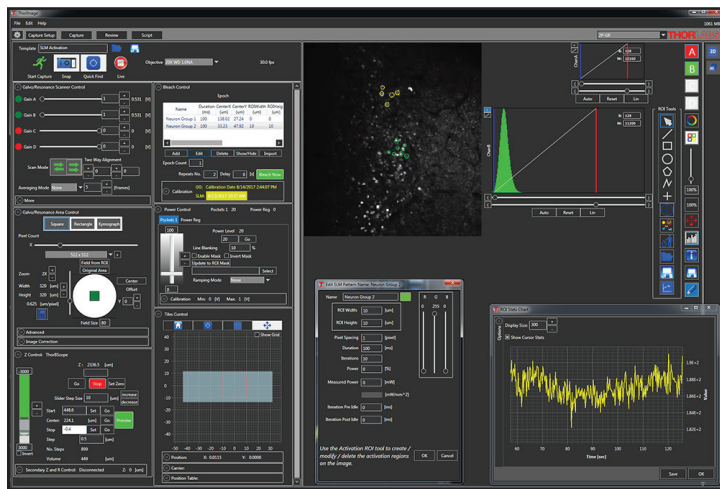

Integrated Laser Control in ThorImage®LS Software

This multiphoton imaging laser offers an average power of >2.3 W at 800 nm and a center wavelength that is tunable from 720 nm to 1060 nm. This 340 nm wide tuning range allows the user to target specific compounds for multiphoton fluorescence imaging and photostimulation/uncaging.

The Tiberius laser emits pulses that are 140 fs in duration. The relatively narrow spectral bandwidth of these pulses was selected in order to reduce the pulse broadening caused by Pockels cells and other dispersive elements while still providing high peak intensity for two-photon excitation.

Controls for the center wavelength, output power, and shutter are seamlessly integrated with our ThorImage®LS software for use in multiphoton microscopy experiments. For frame-by-frame control of the excitation intensity, the Tiberius is also compatible with the open-source ScanImage software (Vidrio Technologies, LLC).

Additionally, the Tiberius laser includes a standalone control GUI that reports the center wavelength and output power of the laser, using the built-in spectrometer to provide real-time diagnostics of the spectral position and shape. User-programmable buttons provide single-click access to commonly used excitation wavelengths.

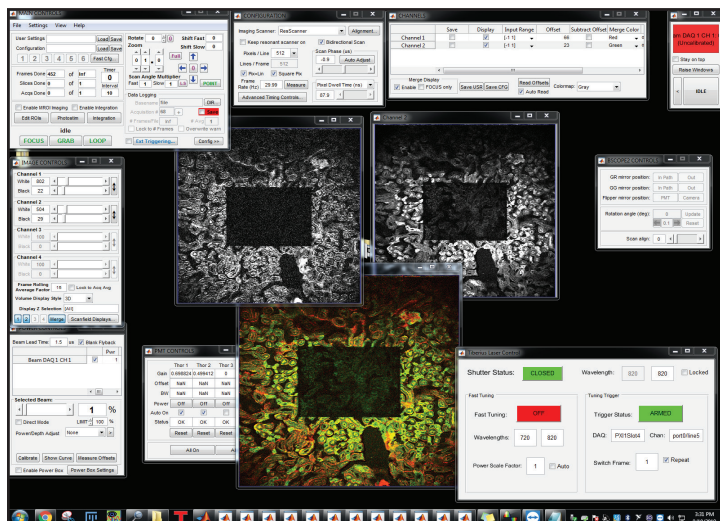

Frame-by-Frame Control of the Excitation Power Available in ScanImage

Designed for Two-Photon Imaging

Multiphoton microscopy takes advantage of the NIR transparency windows in living tissue and highly localized excitation to generate multi-channel fluorescence images of 3D volumes. Compared to visible light, which is used in conventional widefield microscopy and confocal microscopy, NIR light offers significantly reduced scatter and absorption by biological compounds, resulting in a larger penetration depth.

The image of a fruit fly eye to the right demonstrates the Tiberius' ability to resolve morphological features. This two-channel image contains GFP-labeled photoreceptors and unlabeled regions that exhibit multiphoton autofluorescence.

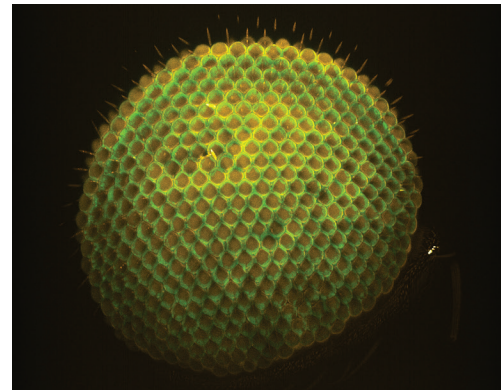

Fruit Fly Eye with GFP-Labeled Photoreceptors and Multiphoton Autofluorescence (Excitation Wavelength: 770 nm)

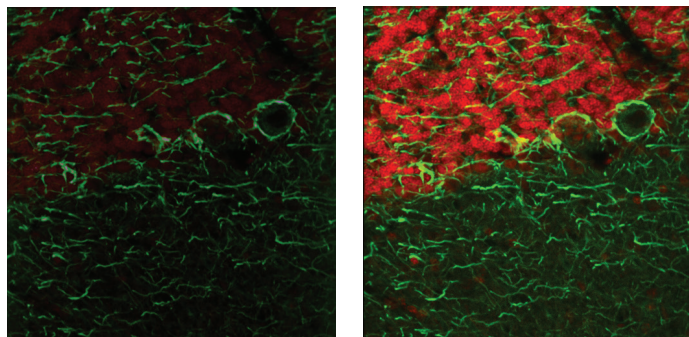
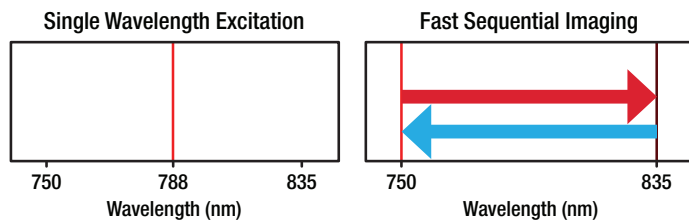

These images show two-photon excitation of a 25 μm thick adult rat brain sagittal section. The red channel corresponds to fluorescence from chick anti-neurofilament, while the green channel corresponds to fluorescence from mouse anti-GFAP. In the left image, the two tags are simultaneously excited at 788 nm, which is a suboptimal excitation wavelength for both. The right image is a composite of a two-color excitation imaging sequence at 7 fps using 750 nm and 835 nm, which excites both tags optimally and provides higher contrast.

Images courtesy of Lynne Holtzclaw of the NICHD Microscopy and Imaging Core Facility, a part of the National Institutes of Health (NIH) in Bethesda, MD.

Fast Wavelength Tuning

With an industry-leading tuning speed of up to 4000 nm/s, the Tiberius is ideal for fast multi-color excitation imaging. For example, users can collect a sequence of two-channel fluorescence images by rapidly switching between the optimal excitation wavelengths of two fluorophores. This process, known as fast tuning, maximizes fluorescence at a lower excitation power, reducing the risk of photobleaching. At full speed, both channels can be collected at an imaging rate of 7 fps with a resolution of 512 x 512 pixels.

Fast tuning is integrated seamlessly into our ThorImage[®]LS software, enabling synchronized control for photoactivation experiments and live high-speed imaging on millisecond timescales using the same laser. Frame-by-frame control of the excitation laser parameters is available through ScanImage, allowing users to compensate for wavelength-dependent changes in average power and variations in fluorophore brightness.



Tiberius Laser with Rotating Bergamo[®] II Microscope (Optical Table Size: 4' x 6')

Tiberius® fs Laser Specifications

Specifications

Item #	TIBERIUS
Tuning Range	720 - 1060 nm
Pulse Width	140 fs
Average Output Power	>1.0 W at 720 nm, >2.3 W at 800 nm, >1.4 W at 920 nm, >0.5 W at 1000 nm, >0.3 W at 1040 nm
Repetition Rate	77 MHz (Nominal)
Noise	<0.15% (RMS, 10 Hz - 1 MHz Measurement Bandwidth)
Beam Diameter (1/e ²)	1.5 mm (Nominal)
M ²	<1.2 at 800 nm
Pointing Stability During Tuning	<50 μrad per 100 nm
Electrical Requirements	
Input Voltage	100 - 240 V
Frequency	50 - 60 Hz
Power Consumption	1.2 kW (Max)
Environmental Requirements	
Room Temperature	17 - 25 °C
Room Temperature Stability	<3 °C Over 24 Hours
Physical Dimensions	
Laser Housing Dimensions (L x W x H)	29.38" x 7.48" x 11.32" (746.3 mm x 190.0 mm x 287.4 mm)

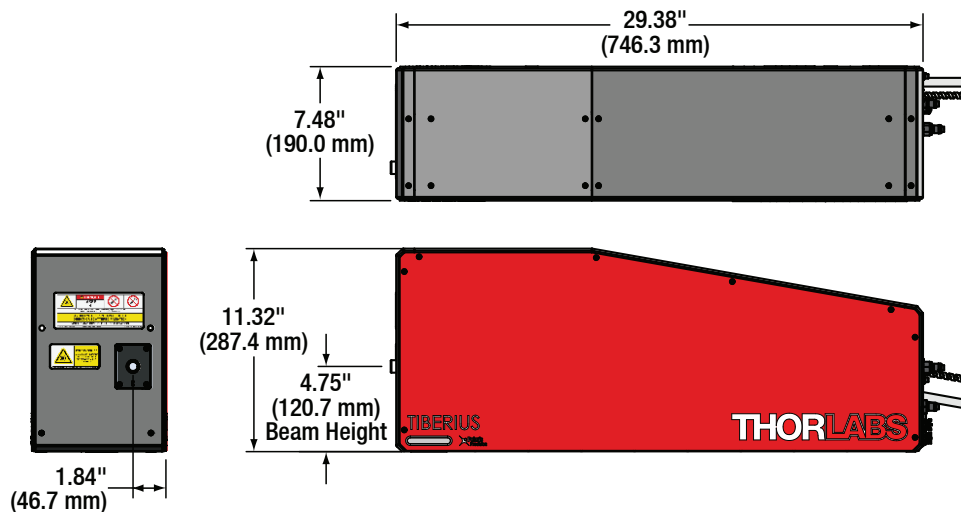

Compact Footprint

Since tabletop space is often at a premium, the Tiberius laser has been designed with a vertical cavity that minimizes the footprint on the optical table. At 29.38" x 7.48", the Tiberius' footprint is about half that of competing designs, preserving valuable workspace for the rest of your experimental setup.

In-House Expertise in Design and Manufacturing

The Tiberius is designed and manufactured entirely in-house, leveraging our multi-disciplinary team of design engineers and the substantial infrastructure of a vertically integrated company. Thorlabs' Laser Division tightly controls every aspect of the manufacturing, assembly, and testing process of the Tiberius in order to guarantee the laser's stability and reliability.

The Tiberius design represents the culmination of complex theoretical cavity simulations combined with "old-fashioned" prototyping. A sound understanding of the intracavity laser dynamics proved fundamental to optimizing the laser for the specific needs of our nonlinear imaging customers.

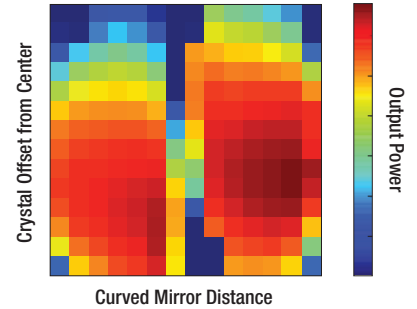

2D Numerical Model of the Tiberius Laser Cavity

Precision Optomechanics Manufacturing



Machine Shop at Thorlabs' Headquarters in Newton, NJ

The Tiberius benefits from Thorlabs' 30+ years of experience in manufacturing precision photonics components and assemblies. For example, it extensively incorporates the high-performance, ultrastable Polaris® optical mounts that the company has developed for custom OEM needs and industrial-grade applications. These expert designs minimize thermally induced drift and help ensure stable long-term alignment.

Our high degree of vertical integration lowers costs to our customers and ensures that every aspect of the laser performs as intended, delivering superior value and return on investment.

Optimized Ultrafast Laser Optics

To maximize the Tiberius' optical performance, it was critical to optimize the laser cavity geometry and optics together as a single unit. The optical coatings were therefore designed by Thorlabs and are precisely tuned for our cavity's proprietary design, enabling the long-term stability and broad tuning range that multiphoton microscopy requires.

To manufacture these high-performance coatings, we selected ion beam sputtering (IBS), which provides the most precise layer control and the densest coatings among all coating methods. These characteristics result in coatings with high damage thresholds, minimal dependence on environmental factors, and excellent consistency from run to run. Thorlabs operates a number of IBS machines to produce these critical components for the Tiberius.



Ion Beam Sputtering (IBS) Chamber for Ultrafast Optics at Thorlabs' Headquarters in Newton, NJ

Femtosecond Pulse Compressor

Features

- ◆ 700 - 1050 nm Wavelength Range
- ◆ -12,500 to 0 fs² Adjustable Dispersion Compensation Range
- ◆ Optimized for >50 fs Input Pulse Width
- ◆ Designed for Ti:Sapphire Multiphoton Imaging Lasers

Thorlabs' FSPC Femtosecond Pulse Compressor helps improve image contrast and quality when working with difficult-to-image samples. It accomplishes this by minimizing the pulse duration in the sample plane and compensating for the group delay dispersion (GDD) that occurs in all complex optical systems, including multiphoton microscopes.

Ultrashort pulses used in multiphoton microscopy are comprised of a spectrum of wavelengths, typically several nanometers wide. As light travels from the laser through the microscope to the sample, each wavelength travels at a different velocity through the optical system, naturally broadening the pulse duration. A broadened optical pulse, and therefore reduced peak intensity, can decrease image contrast and quality when working with challenging samples (see images to the right). By compensating for GDD in the microscope, and hence negating the pulse broadening, the FSPC ensures that the pulse arriving at the sample is as short as possible.

The FSPC features adjustable dispersion compensation up to -12,500 fs² at 800 nm. It can be installed between the femtosecond laser source and the microscope and supports a 4.25" or 4.75" beam height.



FSPC

Without Dispersion Compensation
(Long Pulse at Sample)

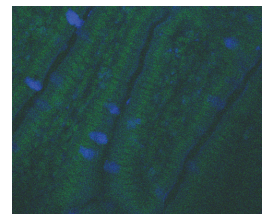

With Dispersion Compensation
(Short Pulse at Sample)

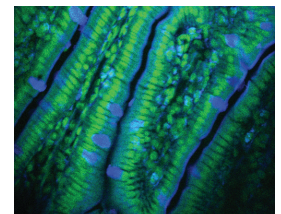

Shorter Laser Pulses Provide Increased Contrast

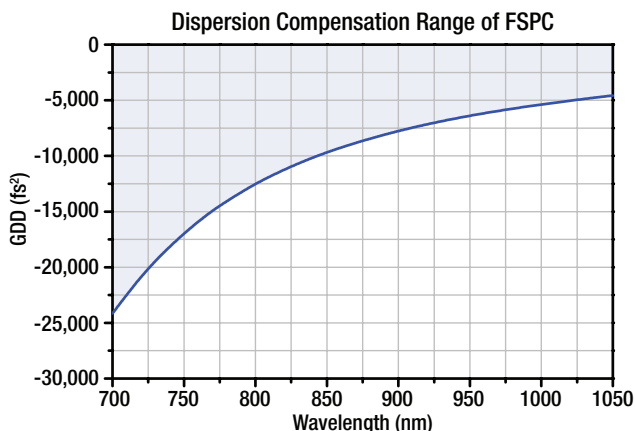
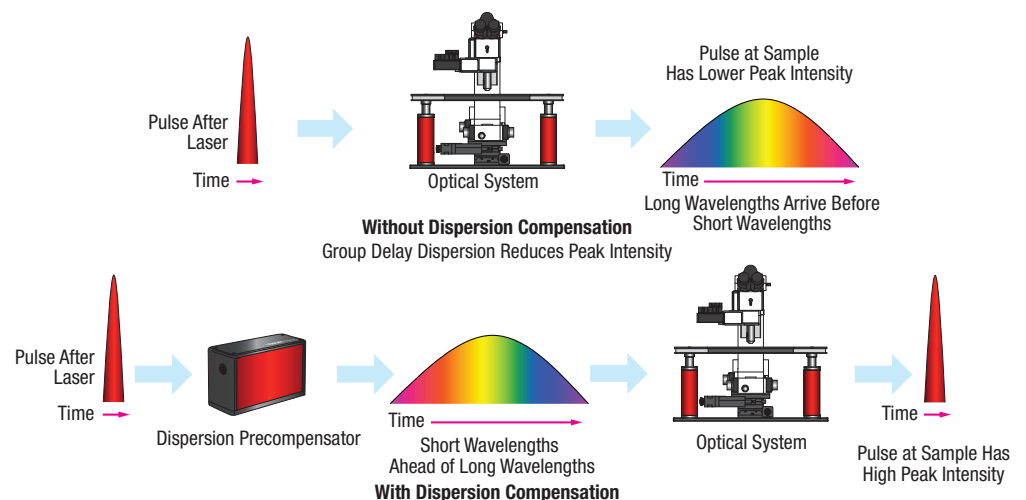

Specifications

Item #	FSPC
Wavelength Range	700 - 1050 nm
Dispersion Range at 800 nm	-12,500 fs ² to 0 fs ²
Transmission at 800 nm	>85%
Input Pulse Width (Recommended)	>50 fs
Input Beam Diameter (1/e ²)	2 mm (Max)
Input/Output Polarization	P-Polarized
Polarization Distortion	<1:200
Pointing Stability	<100 μrad

Dielectric Mirrors with Low GDD

Our Low Group-Delay-Dispersion (GDD) Mirrors are optimized for low dispersion and high reflectance when used with Ti:Sapphire, ytterbium (Yb), neodymium (Nd), thulium (Tm), erbium (Er), or holmium (Ho) lasers.

Low-GDD Dielectric Mirrors

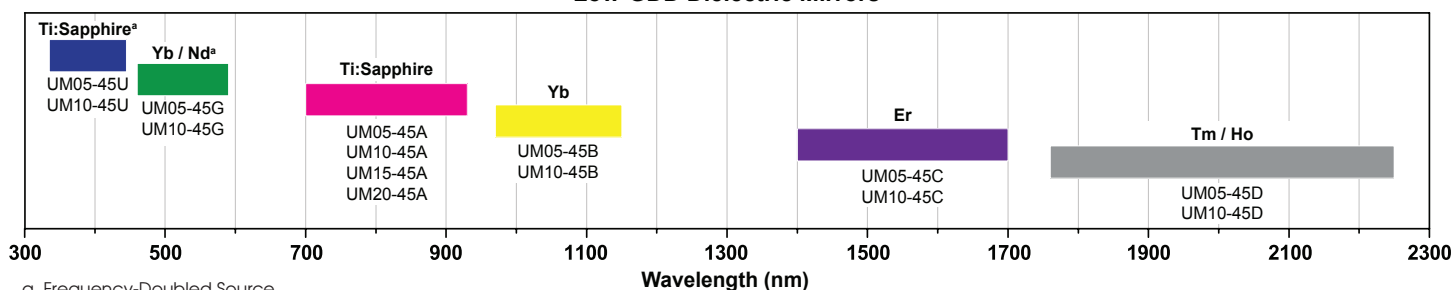

The colored bars represent our selection of low-GDD dielectric mirror coatings available from stock. Each coating is designed to work with a specific laser type, listed above the bar, while the mirrors specified for that wavelength range are indicated by the item #s below the bar. More information is available at www.thorlabs.com.

Optics with Ultrafast-Enhanced Silver Coating

Mirrors coated with an Ultrafast-Enhanced Silver Coating offer a slightly lower reflectance over a much wider wavelength range than dielectric mirrors, making them a great choice when working with low energy lasers.

Specifications

Item #	UM05-AG	UM10-AG	HRS1015-AG	HR1015-AG
Type	Ø1/2" Mirror	Ø1" Mirror	1" x 1" Roof Prism	Ø1" Mounted Roof Prism
Wavelength Range	750 - 1000 nm			
Reflectance at 45° AOI (Absolute)	$R_s > 99.0\%$ $R_p > 98.5\%$	$R_s > 99.0\%$ $R_p > 98.5\%$	$R_s > 99.0\%$ $R_p > 98.5\%$	$R_s > 99.0\%$ $R_p > 98.5\%$
GDD	$ GDD_s < 20 \text{ fs}^2$ $ GDD_p < 30 \text{ fs}^2$	$ GDD_s < 20 \text{ fs}^2$ $ GDD_p < 30 \text{ fs}^2$	$ GDD_s < 40 \text{ fs}^2$ $ GDD_p < 60 \text{ fs}^2$	$ GDD_s < 40 \text{ fs}^2$ $ GDD_p < 60 \text{ fs}^2$

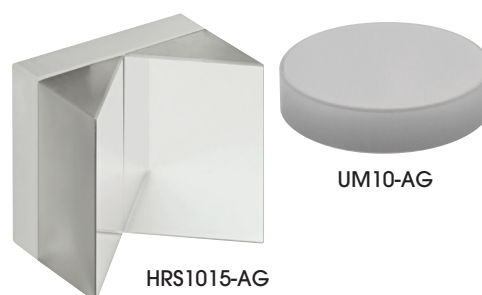

Chirped Mirrors

Our UMC05-15FS and UMC10-15FS mirrors are designed specifically to correct for GDD introduced by fused silica optics in a system. The DCMP175 Chirped Mirror Set compensates for GDD from a complex optical system such as a high-NA microscope objective.

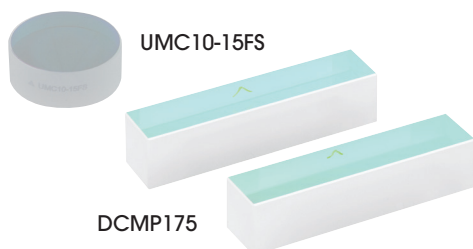

Specifications

Item #	UMC05-15FS	UMC10-15FS	DCMP175
Size	Ø1/2"	Ø1"	53.0 mm x 12.0 mm (Each, Set of 2)
Wavelength Range	650 - 1050 nm		700 - 1000 nm
Reflectance ^a	$R_{\text{abs}} > 99.5\%$ at 10° AOI	$R_{\text{abs}} > 99.5\%$ at 10° AOI	$R_{\text{avg}} > 99\%$ at 8° AOI
GDD per Reflection at 800 nm	-54 fs ² (-1.5 mm of Fused Silica)	-54 fs ² (-1.5 mm of Fused Silica)	-175 fs ²

a. Over Wavelength Range

Controlled-GDD Beamsplitters

Controlled-GDD beamsplitters can split p-polarized light in 20:80, 50:50, 80:20, or 90:10 split ratios with a known dispersion delay.

Specifications



Item #	UFBS2080	UFBS5050	UFBS8020	UFBS9010
Reflectance/Transmission at 45° AOI	$R_{\text{abs}} = 20 \pm 2\%$ $T_{\text{abs}} = 80 \pm 2\%$	$R_{\text{abs}} = 50 \pm 5\%$ $T_{\text{abs}} = 50 \pm 5\%$	$R_{\text{abs}} = 80 \pm 5\%$ $T_{\text{abs}} = 20 \pm 5\%$	$R_{\text{abs}} = 90 \pm 2\%$ $T_{\text{abs}} = 10 \pm 2\%$
Wavelength Range	600 - 1500 nm			
GDD in Reflection	0.2 mm of Fused Silica	0.7 mm of Fused Silica	2 mm of Fused Silica	-
Infrasil [®] Window for Balancing GDD ^a	N/A	UDP05 or UDP10	N/A	N/A

a. Infrasil windows will not fully balance dispersion for beamsplitters with split ratios other than 50:50. Thicker uncoated fused silica windows may be used instead.