

ORCA-Flash4.0 LT+ Digital CMOS Camera C11440-42U30 / C11440-42U31 Instruction manual

Thank you for your purchase

 CAUTION	<ul style="list-style-type: none">• Follow the safety precautions in Chapter 1 in order to avoid personal injury and damage to property when using this camera. The manual describes the correct handling method of the camera and provides instructions that should be followed to avoid accidents. Read this manual carefully before using this camera. After reading this manual, store it in a location where you can refer to it at any time.
--	--



Ver. 1.2
Feb. 2018

HAMAMATSU PHOTONICS K.K.

1. SAFETY PRECAUTIONS







1-1 SYMBOLS

The following symbols can be found on this camera:

	Direct current
	Alternating current

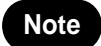
1-2 CLASSIFICATION OF WARNINGS

We have classified the warnings symbols that appear in this instruction manual and on the camera as follows for your convenience. Make sure that you fully understand them and follow the instructions they contain.

 WARNING	Improper handling of the camera without observing these warnings could lead to serious injury to the user and even death.
 CAUTION	Improper handling of the camera without observing these cautions could lead to personal injury to the user or damage to property.
 Note	This symbol indicates a note to help you get the best performance from the camera. Read the contents of the note carefully to ensure correct and safe use. Failure to observe one of these notes might impair the performance of the camera.
	This symbol indicates a cautionary item that should be followed when handling the camera. Read the contents carefully to ensure correct and safe use.
	This symbol indicates an action that is forbidden. Read and follow the instructions carefully.
	This symbol indicates a compulsory action or instruction. Read and follow the instructions carefully.

 **WARNING**



Power supply

Use the camera with the indicated voltage on the rating sticker. Using a different voltage can damage the camera and lead to fire or electric shock.



Cables

Do not to place heavy objects on cables or bend them excessively. Doing so can damage the cables and lead to fire or electric shock.



Power supply cord

Use the accessory power supply cord when using this camera.



AC adapter

Use the accessory AC adapter when this camera is used.



Do not touch the plug with wet hands. Doing so can lead to electric shock.



Do not attempt to dismantle or modify the camera

Doing so can also lead to damage and even injury, as some internal components become very hot or high voltage. Do not touch parts that are not indicated in this manual.



Do not insert a foreign substance into the camera

Such as combustible substances, metal objects or water to get inside the camera. These can damage the camera and lead to fire or electric shock.



In the event of an anomaly

Such as the image suddenly disappearing or the occurrence of a strange noise, a strange smell or smoke coming from the camera, immediately turn off the power switch and unplug the power supply cord and contact Hamamatsu subsidiary or your local distributor. Do not attempt to repair the camera yourself.

 **CAUTION**



AC adapter

When unplugging the power supply cord, do not pull on the cord. Remove the plug from the outlet to avoid causing electric shock or fire.



When unplugging the AC adapter, do not pull on the cord. Remove the plug from the camera to avoid breakdown of the AC adapter or the camera.



If the camera is not in use for a long period of time, unplug the power supply cord from the outlet to avoid damaging the cord and causing electric shock or fire.



Connecting and disconnecting cables

Always turn off the camera before connecting and disconnecting cables.



Mounting the camera

When mounting the camera to a tripod or other fixture, use the optional base plate. Be careful that the mounting screw does not enter more than 8 mm from the surface of the base plate. Screwing it in further can impair normal operation.



Lenses (C11440-42U30)

Be careful not to screw the lens more than 7 mm into the C-mount of the camera. Doing so can scratch the protective glass. (Some wide-angle lenses in particular can have a thread of 7 mm or more.)



Shipping precautions

When transporting the camera by truck, ship, airplane, etc., wrap it securely in packaging material or something similar.



Strong impact

Do not subject the camera to strong shocks (such as dropping it). Doing so can damage the camera.



Operating environment

This camera is designed and tested for use in an industrial environment. If this camera is used in residential areas, EMI (electro-magnetic interference) may occur. This camera must not be used in residential areas.



Disposal

When disposing of the camera, take appropriate measures in compliance with applicable regulations regarding waste disposal and correctly dispose of it yourself, or entrust disposal to a licensed industrial waste disposal company. In any case, be sure to comply with the regulations in your country, state, region or province to ensure the camera is disposed of legally and correctly.

2. CHECK THE CONTENTS OF PACKAGE

When opening the package, check that the following items are included before use. If the contents are incorrect, insufficient, or damaged in any way, contact a Hamamatsu subsidiary or your local distributor before attempting to operate the camera.

Camera (C11440-42U30 or C11440-42U31)	1
AC adapter	1
Power supply cord for AC adapter	1
Lens mount cap (attached to the camera)	1
C11440-42U30/C11440-42U31 Before Use (Booklet)	1
C11440-42U30/C11440-42U31 Instruction manual (CD-ROM)	1

[Option]

SMA-BNC cable	A12106-05
SMA-SMA cable	A12107-05
USB 3.0 A to Micro B cable	A12046-03
USB 3.0 interface board	M9982-26
Adjuster pole	A11185-01
Base plate	A11186-01

Note

- The cable listed in option is highly recommended for use with the camera. The camera may not confirm to CE marking regulation if other type of cable is used with.

Note

- If you use the adjuster pole and the base plate, please refer to the respective installation manual.

3. INSTALLATION

Avoid using or storing this camera in the following places



- Places where the temperature is not the operating temperature indicated in the specifications.
- Places where the temperature is not the storage temperature indicated in the specifications.
- Places where the temperature varies greatly.
- In direct sunlight or near a heater.
- Places where the humidity levels are not the operating humidity levels indicated in the specifications and where the system may be exposed to liquid.
- Places where the humidity levels are not the storage humidity levels indicated in the specifications and where the system may be exposed to liquid.
- Close to a strong source of magnetism or radio waves.
- Places where there are vibrations.
- Places where the system may come into contact with corrosive gases (such as chlorine or fluorine).
- Places where there is a lot of dust.

How to place the camera (when the camera is placed on a table)



Do not place the camera the rear panel of the camera, which connectors are located, to be at the bottom. (Do not block ventilation openings.)

Do not block ventilation openings



To prevent overheating in the camera's interior, do not wrap the camera in cloth or any other material, or in any way allow the camera's ventilation ports to become blocked. If the camera is being operated in a closed environment, ensure clearance of at least 10 cm from both the intake and exhaust vents when setting up.

Contents

1. SAFETY PRECAUTIONS	1
1-1 SYMBOLS.....	1
1-2 CLASSIFICATION OF WARNINGS.....	1
2. CHECK THE CONTENTS OF PACKAGE	4
3. INSTALLATION	5
4. OVERVIEW	8
5. FEATURES	8
6. NAME AND FUNCTION OF PARTS	10
7. CONNECTION	13
7-1 CONNECTING OF CABLES	13
8. OPERATIONS	14
8-1 OPERATING PRECAUTIONS.....	14
8-2 PREPARING FOR IMAGING	14
8-3 IMAGING.....	14
8-4 END OF IMAGING	14
9. DESCRIPTION OF VARIOUS FUNCTIONS	15
9-1 THEORY OF THE CMOS IMAGE SENSOR.....	15
9-2 NORMAL AREA MODE	17
9-2-1 Readout method (Scan mode)	17
9-2-2 Camera operation modes	18
9-2-3 Frame rate calculation	19
9-2-4 Configuring exposure time.....	22
9-2-5 Timing chart of camera operation modes	23
9-3 W-VIEW MODE.....	35
9-3-1 Readout method (scan mode).....	35
9-3-2 Camera operation modes	36
9-3-3 Frame rate calculation	36
9-3-4 Configuring exposure time.....	39
9-3-5 Timing chart of camera operation modes	40
9-4 REAL-TIME CORRECTION FUNCTIONS	43
10. PRECAUTION WHEN USING the CMOS IMAGE SENSOR	44
11. MAINTENANCE	45
11-1 CARE	45
12. TROUBLESHOOTING	46
12-1 IMAGE IS NOT TRANSFERRED	46
12-2 ALTHOUGH IMAGES ARE TRANSFERRED	46
13. SPECIFICATIONS	47
13-1 CAMERA SPECIFICATIONS	47
13-2 SPECTRAL RESPONSE CHARACTERISTICS(TYP.)	50

14. DIMENSIONAL OUTLINES	51
14-1 C11440-42U30 for C-mount	51
14-2 C11440-42U31 for F-mount.....	52
15. WARRANTY	53
15-1 BASIC WARRANTY	53
15-2 REPAIRS.....	53
16. CONTACT INFORMATION	54

4. OVERVIEW

C11440-42U30/C11440-42U31 is equipped with the new scientific image sensor, an advanced CMOS device that realizes the multiple benefits of high resolution, high readout speed, and low noise all at once.

The camera provides 4.0 megapixels resolution at 30 fps (frames/s) (and up to 25 000 fps by sub-array readout) while achieving 0.9 electrons (median) 1.5 electrons (r.m.s) readout noise performance. Moreover, the camera delivers high sensitivity through its on-chip micro lens, 33 000:1 high dynamic range that makes the camera suitable for almost any scientific application from bright field imaging to low-light fluorescence imaging across a wide spectral range. Various external trigger functions and timing output functions ensure proper timing control with peripheral equipment to cover a wide range of applications.

The camera is the new scientific digital camera for life science microscopy, semiconductor inspection, x-ray scintillator readout or industrial imaging.

5. FEATURES

(1) Readout noise

In the camera, the pixel amplifier is optimized: it has high gain from optimizing the semiconductor process, and the difference among pixel amplifiers are greatly minimized. In addition, there is on-chip CDS (correlated double sampling) circuit, which plays an important role in achieving low noise. Moreover, the sensor features a split readout scheme in which the top and bottom halves of the sensor are readout independently, and the data of each horizontal line is read by 2 lines of column amplifier and A/D in the top and the bottom in parallel and simultaneously. As a result, it achieves very fast readout speed while keeping very good low-noise performance.

The camera has lower readout noise (0.9 electrons (median), 1.5 electrons (r.m.s)) than the conventional cooled CCD camera. Moreover, high-speed readout (30 fps with 2048 pixels × 2048 pixels) with very low readout noise, which was impossible, can now be achieved.

(2) Cooling structure

In the camera, the CMOS image sensor is cooled down by a peltier element to suppress the dark current. The camera has a special chamber structure to avoid the condensation.

(3) Pixel number and pixel size

The CMOS image sensor has 6.5 μm × 6.5 μm pixel sizes that is equivalent to conventional CCD image sensor (2/3 inch, 1.3 megapixels). Also, the camera can observe a wider field of view because the pixel number is about 3 times that of the conventional CCD image sensor (2/3 inch, 1.3 megapixels)

(4) Readout method

The camera has a variety of readout modes. In addition to full resolution readout mode, sub-array readout and binning readout are supported.

(5) Frame rate

The CMOS image sensor realizes both low noise (0.9 electrons (median) 1.5 electrons (r.m.s)) and high speed readout (30 fps with 2048 pixels x 2048 pixels) simultaneously, by a split readout scheme in which the top and the bottom halves of the sensor are readout independently, and the data of each horizontal line is read by 2 lines of column amplifier and A/D in the top and the bottom in parallel and simultaneously.

(6) Real-time correction functions

When using the camera, there is a case that shading caused by uneven illumination or optics is not negligible in the image. Also, there are a few pixels in the CMOS image sensor that have slightly higher readout noise performance compared to surrounding pixels. For those cases, the camera has real-time offset level, shading and defective pixel correction features to further improve image quality. The correction is performed in real-time without sacrificing the readout speed at all.

(7) Interface

This camera has USB 3.0 interface.

USB 3.0 interface is able to transfer 4 megapixels image with 30 fps.

It is versatile interface. It transfers image with moderate transfer speed.

(8) Camera operation modes

The camera has three operation modes: 1) the free running mode, in which the exposure and readout timing are controlled by the internal microprocessor, and 2) the external trigger mode, in which the exposure and readout timing are decided by an external trigger. 3) the start trigger mode is used to start operating the camera by a trigger input for a continuous imaging.

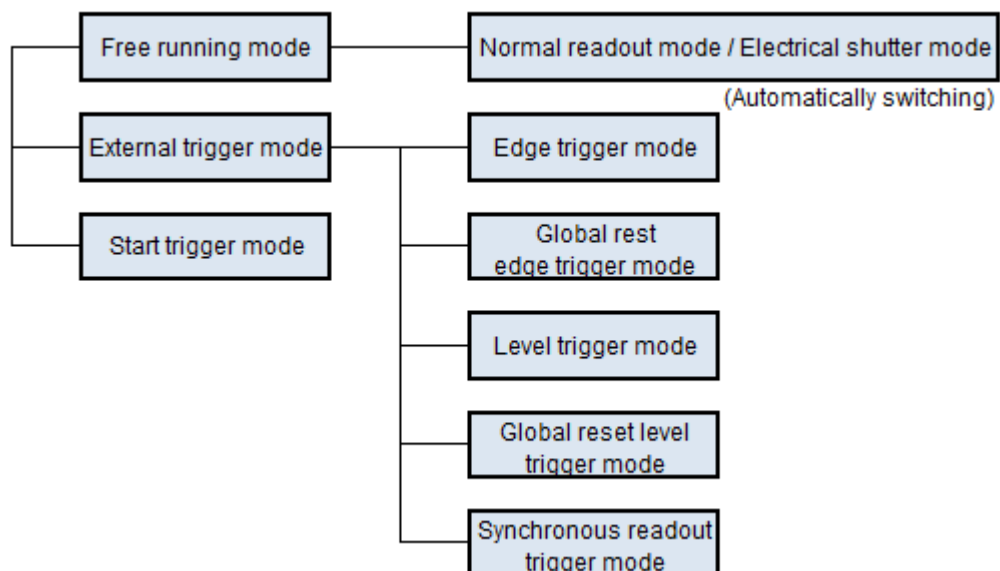

6. NAME AND FUNCTION OF PARTS

(1) C11440-42U30 for C-mount

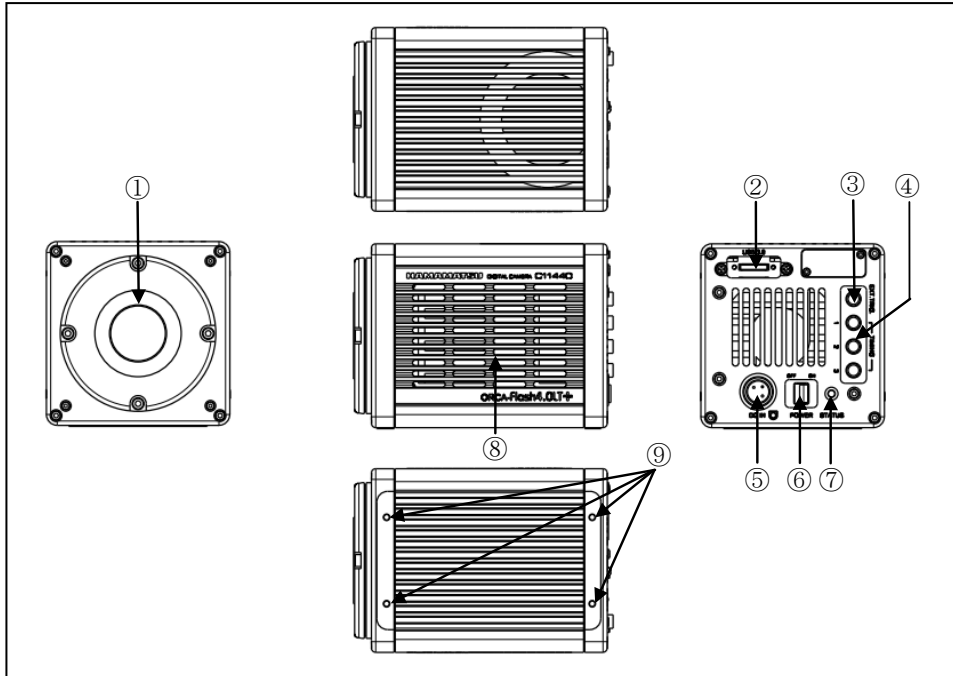

(2) C11440-42U31 for F-mount

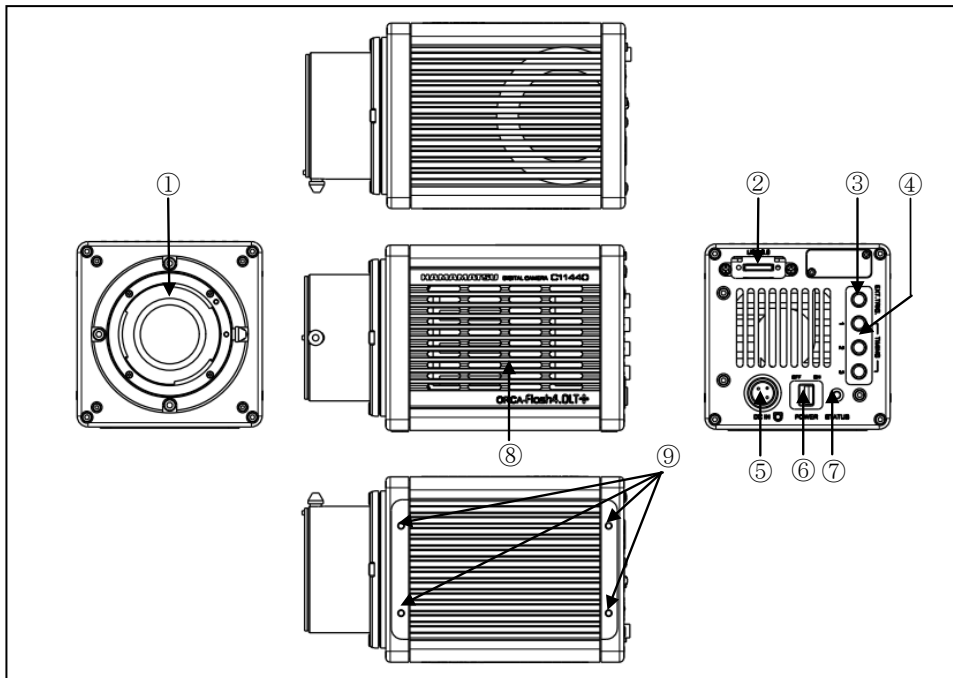

CAUTION • Do not place the rear panel of the camera, which connectors are located, to be at the bottom (Do not block ventilation openings.).

① Lens mount

C11440-42U30 can be attached to C-mount lens or an optics system.
C11440-42U31 can be attached to F-mount lens or an optics system.

Note

- The depth of the C-mount is 7 mm. Screwing in the mount too far can scratch the glass surface.

② USB 3.0 interface connector [USB 3.0]

This is connected to the USB 3.0 interface connector on the computer.

③ Trigger input connector [EXT.TRIG]

This is used when the camera is being operated using external synchronization. Input is 3.3 V LVCMOS level, and input impedance is 10 k Ω . When an external trigger is input, the trigger is activated at the falling or rising edge of the signal. (You can choose external trigger polarity between Negative and Positive.)

④ Timing out connector 1,2,3 [TIMING 1,2,3]

This is used when peripheral device(s) require synchronization with the camera. Output is 3.3 V LVCMOS level, and it is output through BUS TRANSCEIVER IC SN74AVC8T245. Output impedance is 33 Ω .

Note

- Determine termination according to cable length and so on.

⑤ DC power input connector [DC IN]

This is the power supply terminal. Use the accessory AC adapter.

⑥ Power switch [POWER]

The power is turned ON/OFF.
When the power switch is set to "ON", the camera turns on and starts initialization and the lamp blinks in orange.
When the initialization is completed, the lamp color stays in green.
When the camera transfers data and the lamp color is orange.
When the power switch is set to "OFF", the camera returns to the power off state and the lamp turns off.

⑦ STATUS lamp [STATUS]

The LED indicates status of camera.

Lighting color	Status of power distribution
Turn off (no color)	Power off
Orange (Blinking)	Initialization
Green (lighting)	Power on
Orange (lighting)	Data transfer
Red (lighting)	Heat up

CAUTION

- When the camera heats up, stop operation and unplug the AC adapter immediately.

⑧ **Air outlet**

This is the outlet for the heat ventilation.



- To prevent overheating inside the camera, do not wrap the camera in cloth or other material, or block the camera's ventilation.



- If the camera is being operated in an enclosed environment, ensure to keep clearance at least 10 cm from both intake and exhaust vents when setting up.

⑨ **Installation holes for base plate**

These are the holes to install the base plate.



- If you use the adjuster pole and the base plate, see each installation manual.

7. CONNECTION

7-1 CONNECTING OF CABLES

Refer to the figure below when connecting the various cables.

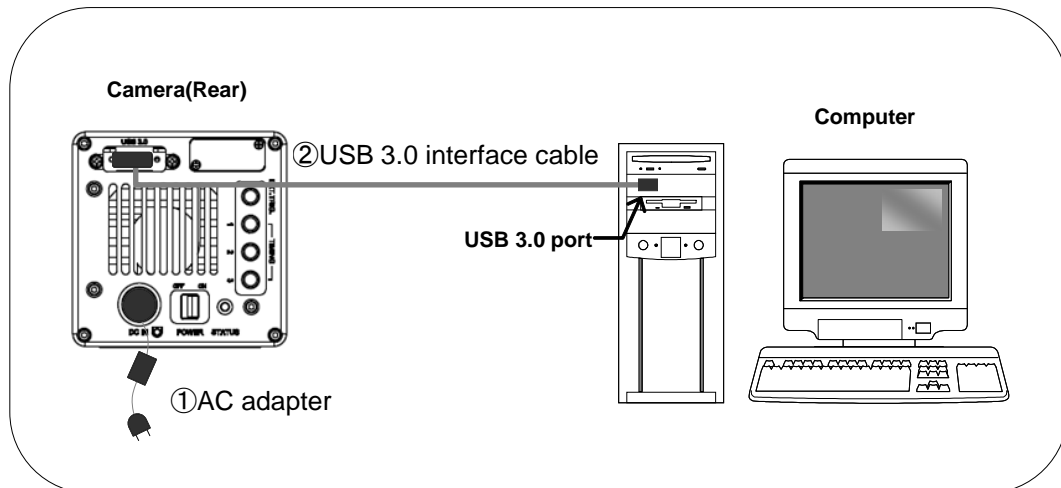

Figure 7-1



- When you connect cables, turn off the power supply of the camera and the peripheral devices.



- If you use the adjuster pole and the base plate, see each installation manual.

CAUTION

- Do not place the rear panel of the camera, which connectors are located, to be at the bottom (Do not block ventilation openings.).

① AC adapter

This is the cord to supply a power supply. Use the accessory AC adapter.

② USB 3.0 interface cable (Option)

This is the cable to connect the USB 3.0 interface connector of the camera and the USB 3.0 interface connector on the computer.

Note

- Hamamatsu recommends A12046-03 optional USB 3.0 interface cable for this camera. The camera complies with EMC direction with using A12467-03 USB 3.0 interface cable. Be careful that the camera with other interface cable may not fulfill the EMC directive requirements.

8. OPERATIONS

8-1 OPERATING PRECAUTIONS

Be careful of the following when you operate the camera.

(1) Cooling method

Cooling of this equipment is done using a Peltier element. With a Peltier element, when current is supplied, one surface is cooled, and the other surface is heated. The CMOS image sensor is positioned on the cooling side, and cooling is done by discharging the heat from the heated surface. This cooling method is passive air-cooling.

(2) Ambient temperature

The recommended ambient temperature for camera operation is between 20 °C and 25 °C. Thus, the maximum temperatures to which the CMOS image sensor can be cooled, and the stability of the cooled temperature, are affected by the ambient temperature. The ambient temperature should be maintained at a constant temperature in order for cooling to be effective.

(3) Protection circuit

This camera's thermoelectric cooling device is protected by a thermal protection circuit. If the internal temperature of the camera becomes abnormally hot, the protection circuit operates to inform the user by a buzzer alarm (beep tone) and lighting the camera's red LED light while simultaneously cutting the current supply to the Peltier element. As soon as this protection is implemented, turn off the power switch and unplug the AC supply. Then remove the cause of the overheating.

8-2 PREPARING FOR IMAGING

Use the following procedure when starting operating of the camera.

- (1) Connect devices as shown in Figure 7-1 before you start operation.
- (2) Turn on the computer's power switch.

The cooling temperature becomes stable about 5 minutes after cooling begins.



- When the cables are connected, confirm the power switch of peripheral device is in the OFF position.

8-3 IMAGING

Start the control and imaging with the application software.

Note

- Please refer to the instruction manual attached to the software for the way of using it and the details.

8-4 END OF IMAGING

Carry out the procedure below when imaging is finished.

- (1) End the imaging or transmission of image data with the application software.
- (2) Turn off the power to the peripheral device.

9. DESCRIPTION OF VARIOUS FUNCTIONS

9-1 THEORY OF THE CMOS IMAGE SENSOR

The pixel of the CMOS image sensor is composed of the photodiode and the amplifier that converts the charge into voltage. Entered light is converted to charge and converted to voltage in the pixel. The voltage of each pixel is output by switching the switch one by one. (Figure 9-1)

The scientific CMOS image sensor used in this camera has an on-chip CDS (correlated double sampling) circuit, which plays an important role in achieving low noise. In addition, the CMOS image sensor realizes both low noise and high speed readout simultaneously, by a split readout scheme in which the top and the bottom halves of the sensor are readout independently, and the data of each horizontal line is read by 2 lines of column amplifier and A/D in the top and the bottom in parallel and simultaneously.

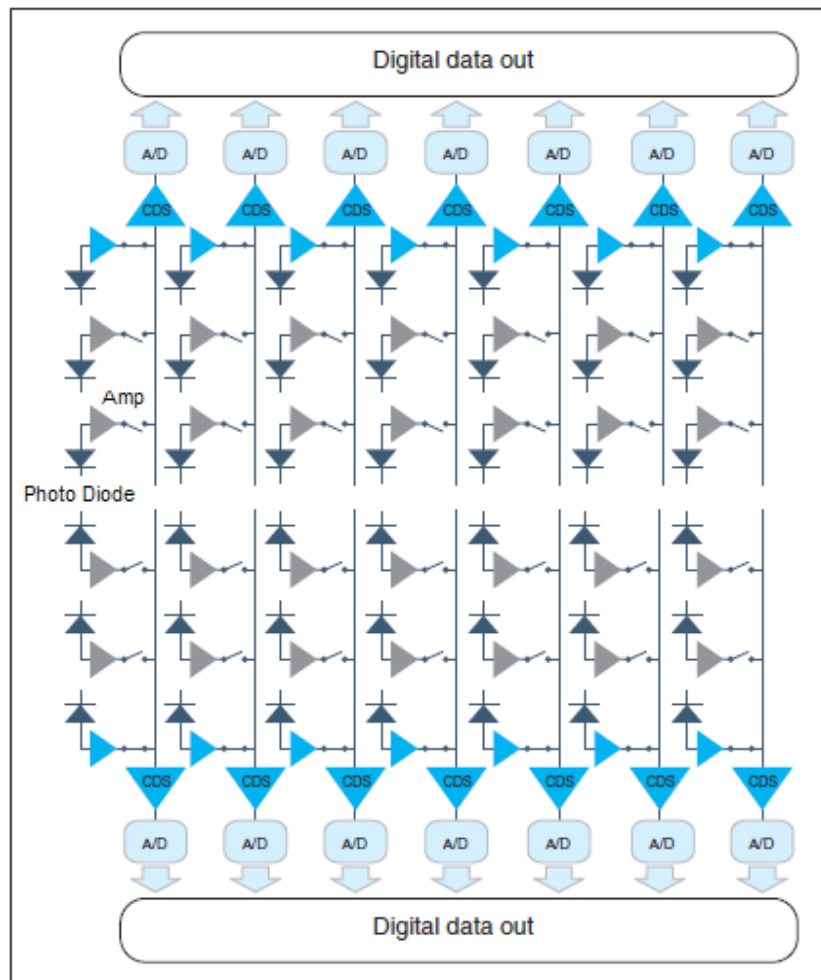

Figure 9-1 Structure of the CMOS image sensor

The exposure and the readout method of the CMOS image sensor is rolling shutter. In the rolling shutter, the exposure and readout are done line by line. Therefore, the exposure timing is different on one screen. (Figure 9-2)

But even if the object moves during the exposure, the affect of rolling shutter is very small.

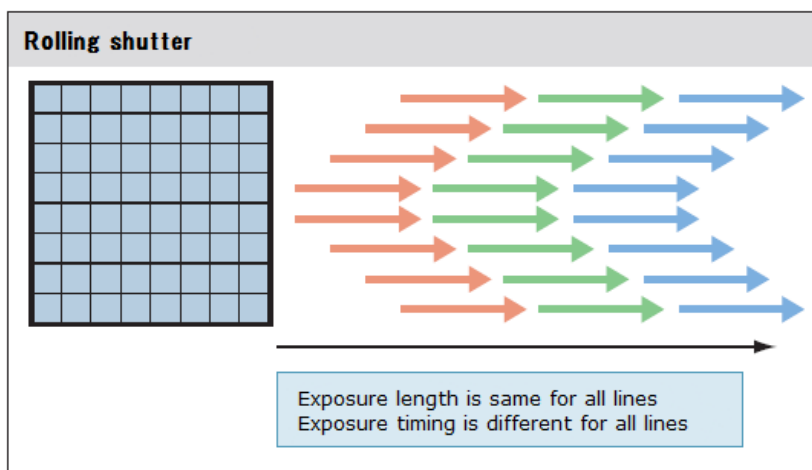

Figure 9-2 Exposure timing of Rolling shutter

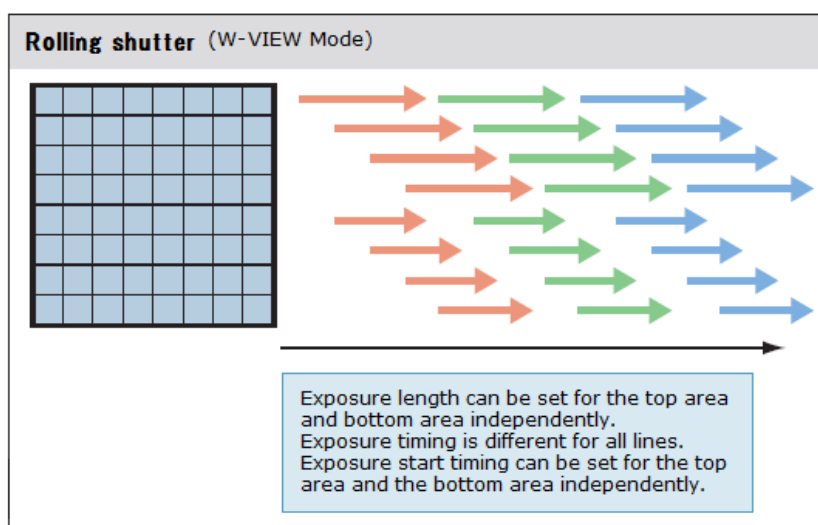

Figure 9-3 Exposure timing of Rolling shutter (at W-VIEW Mode)

9-2 NORMAL AREA MODE

9-2-1 Readout method (Scan mode)

With normal area mode, the camera reads out the CMOS image sensor from the center line to the top and from the center line to the bottom simultaneously (center line is depicted in red line in the diagram).

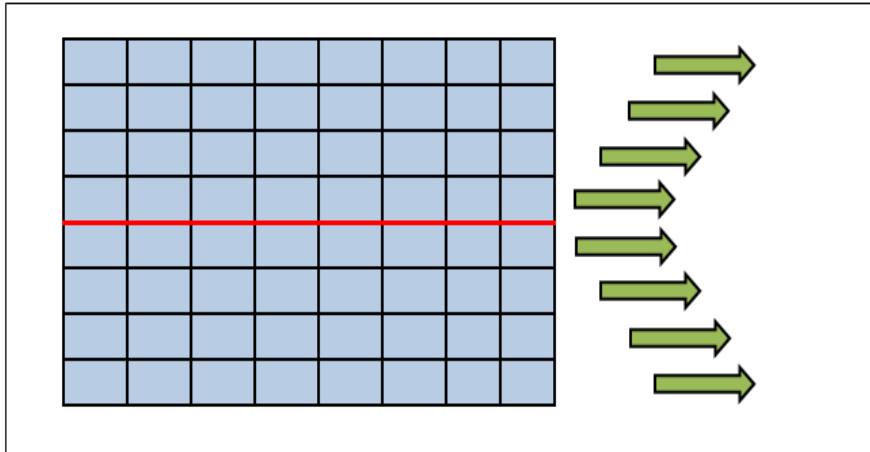

Figure 9-4 Readout method of normal area mode

The camera has the following scan modes.

(1) Normal readout

Perform charge readout from camera individually for all pixels.

(2) Binning readout

With this camera, 2x2 binning readout and 4x4 binning are available by adding the signal of adjacent pixels in the digital domain. Binning readout is a method for achieving high sensitivity in exchange for losing resolution.

(3) Sub-array readout

Sub-array readout is a procedure only a region of interest is scanned. It is possible to increase the frame rate by reducing the number of vertical lines scanned. When a target area is placed in the center of the screen, sub-array readout can perform the fastest readout. In sub-array readout, binning configuration is enabled.

Size and a position of the readout area can be configured according to the table below.

Binning	Settings			
	Horizontal		Vertical	
	Size	Position	Size	Position
1x1 (Normal readout)	512 pixels	32 pixels	8 lines	4 lines
2x2 binning readout	256 pixels	16 pixels	4 lines	2 lines
4x4 binning readout	128 pixels	8 pixels	2 lines	1 lines

(4) Rapid Rolling Mode

This readout mode is preferred to be used when acquiring images of fast moving samples in order to minimize distortion come from rolling shutter.

Note

- Please refer to 9-2-3 [FRAME RATE CALCULATION] about the frame rate of each readout mode. However, Rapid Rolling mode is different from other modes.

9-2-2 Camera operation modes

The camera has the following operation modes.

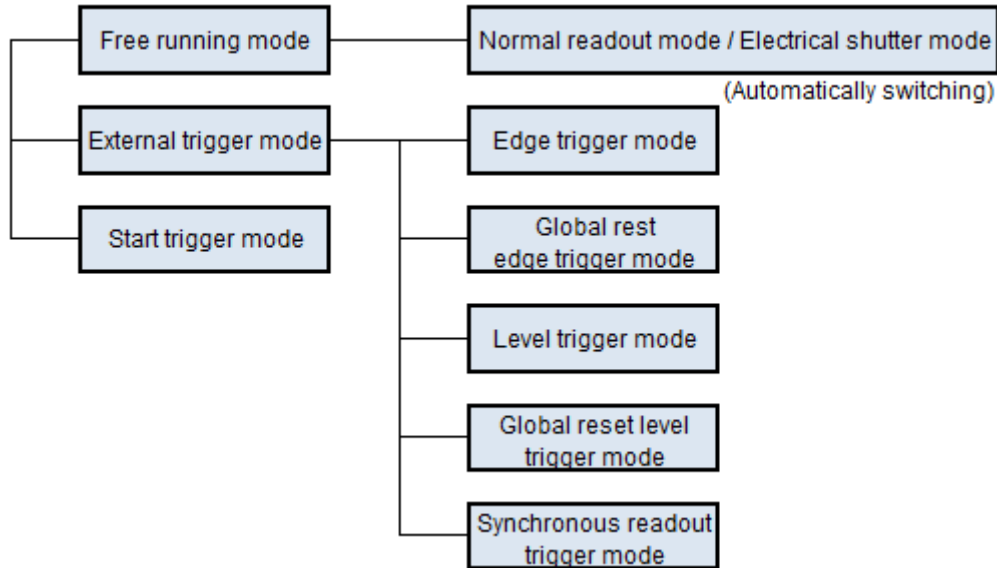

(1) Free running mode

The camera has the free running mode which the exposure and readout timing can be set by software command and controlled by an internal microprocessor. The free running mode has normal readout mode (in which the exposure time is longer than the 1 frame readout time) and electrical shutter mode (in which the exposure time is shorter than the 1 frame readout time). These readout modes are automatically switched depending on the exposure time setting.

(2) External trigger mode

The camera has various external trigger functions to synchronize the camera with the external equipment. In the external trigger mode, the external equipment becomes a master and the camera becomes a slave.

① Edge trigger mode / Global reset edge trigger mode

The edge trigger mode is used so that the exposure starts according to an external signal.

② Level trigger mode / Global reset level trigger mode

The level trigger mode is used to control both exposure start timing and exposure time length by inputting external trigger pulses.

③ Synchronous readout trigger mode

The synchronous readout trigger mode is used for continuous imaging when it is necessary to control the exposure start timing of each frame from an external source. It is useful for confocal microscopy.

(3) Start trigger mode

The start trigger mode is to start operating the camera by a trigger input for a continuous imaging.

Note

- Please refer to 9-2-5 [TIMING CHART OF CAMERA OPERATION MODES] about the detail of timing chart of these modes.

9-2-3 Frame rate calculation

The calculation formula of frame rate and the value of frame rate are as below.

■ Calculation formula

V_n = Number of vertical line
 (The center of the set area is the middle of the sensor.)
 $Exp1$ = 3 ms to 10 s
 $1H$ = 32.4812×10^{-6}

Free running mode	$1/(V_n/2 \times 1H)$
External trigger mode (Edge/Level)	$1/(V_n/2 \times 1H + Exp1 + 1H \times 10)$
External trigger mode (Synchronous readout)	$1/(V_n/2 \times 1H + 1H \times 18)$



- The Exp1 value has to be input to the calculation formula below in units of seconds.

■ Value of frame rate

Horizontal width x Vertical width		Free running mode	External trigger mode (Edge/Level)	External trigger mode (Synchronous readout)
2048	2048	30	27	29
	1024	60	50	58
	512	120	85	112
	256	240	133	210
	128	481	185	375
	64	962	229	615
	8	7696	289	1399

(fps)

The calculation formula of frame rate and the value of frame rate for Rapid Rolling Mode are shown in next page.

■ Calculation formula (Rapid Rolling Mode)

- V_n = Number of vertical line
 (The center of the set area is the middle of the sensor.)
 $Exp1$ = 1 ms to 10 s
 $Exp2$ = 1.05 ms to 10 s
 $1H$ = 10×10^{-6}
 $int()$ = The decimal point is rounded down.



- The $Exp1$ and $Exp2$ values must be input to the calculation formula below in units of seconds.

	Binning	Horizontal width	Vertical width	Calculation formula
Free running mode	1x1	1024 1536 2048	---	$1/(int(V_n/2048/30/1H) \times 1H)$
	1x1	512	---	$1/(V_n/2 \times 1H)$
	2x2 4x4	---	---	
External trigger mode (Edge trigger)	1x1	1024 1536 2048	$112 \leq V_n \leq 2048$	$1/(int(V_n/2048/30/1H) \times 1H)$
	1x1	1024 1536 2048	$8 \leq V_n \leq 104$	$1/(V_n/2 \times 1H + 1H \times 10 + Exp1)$
	1x1	512	---	
	2x2 4x4	---	---	
External trigger mode (Level trigger)	1x1	1024 1536 2048	$112 \leq V_n \leq 2048$	$1/(int(V_n/2048/30/1H) \times 1H)$
	1x1	1024 1536 2048	$8 \leq V_n \leq 104$	$1/(V_n/2 \times 1H + 1H \times 4 + Exp2)$
	1x1	512	---	
	2x2 4x4	---	---	
External trigger mode (Synchronous readout)	1x1	1024 1536 2048	$32 \leq V_n \leq 2048$	$1/(int(V_n/2048/30/1H) \times 1H)$
	1x1	64 1024 1536 2048	$8 \leq V_n \leq 24$	$1/(V_n/2 \times 1H + 1H \times 18)$
	1x1	512	---	
	2x2 4x4	---	---	

Value of frame rate (Rapid Rolling Mode)

(fps)

	Vertical width \ Horizontal width	1x1 (Normal readout)		Binning: 2x2 / 4x4
		1024 / 1536 / 2048	512	---
Free running mode	2048	30	97	97
	1024	60	195	195
	512	120	390	390
	256	240	781	781
	128	480	1562	1562
	64	961	3125	3125
	8	7692	25 000	25 000
External trigger mode (Edge trigger)	2048	30	88	88
	1024	60	160	160
	512	120	273	273
	256	240	420	420
	128	480	574	574
	64	704	704	704
	8	877	877	877
External trigger mode (Level trigger)	2048	30	88	88
	1024	60	161	161
	512	120	273	273
	256	240	421	421
	128	480	578	578
	64	709	709	709
	8	884	884	884
External trigger mode (Synchronous readout)	2048	30	95	95
	1024	60	188	188
	512	120	364	364
	256	240	684	684
	128	480	1219	1219
	64	961	2000	2000
	8	4545	4545	4545

Note

- The calculation formula and the frame rate value of Start trigger mode (External trigger mode) are same as the free running mode. About this mode, refer to 9-2-5-2-4 [Start trigger mode].

9-2-4 Configuring exposure time

The exposure time setting can be done by absolute value. The actual exposure time setting is defined by the following formula, and the camera automatically calculates a larger and closest value from the specified exposure time setting.



- The Exp1 values must be input to the calculation formula below in units of seconds.

$$32.4812 \mu\text{s} \times \text{Exp2}$$

Exp1 = 3 ms to 10 s (at sub-array 129.99 μs to 10 s)

Exp2 = $\text{Exp1} \times 10^6 \div 32.4812 \mu\text{s}$ (round up at decimal point)

The actual exposure time setting for Rapid Rolling Mode is defined by the following formula.

$$10 \mu\text{s} \times \text{Exp2}$$

Exp1 = 1 ms to 10 s (at sub-array 40 μs to 10 s)

Exp2 = $\text{Exp1} \times 10^6 \div 10 \mu\text{s}$ (round up at decimal point)

Available setting range of the exposure time is the following.

Free running mode	3 ms to 10 s
	1 ms to 10 s (Rapid Rolling Mode)
Free running mode (at Sub-array)	129.99 μs^* to 10 s
	40 μs^* to 10 s (Rapid Rolling Mode)
External trigger mode	3 ms to 10 s
	1 ms to 10 s (Rapid Rolling Mode)

Note

* 129.99 μs and 40 μs (Rapid Rolling Mode) for the Free running mode (at Sub-array) is the minimum exposure time when sub-array is set to 8 lines vertically symmetric (4 lines in top half and 4 lines in bottom half) with respect to the horizontally center axis. The minimum exposure time vary depend on vertical line number of sub-array setting.

9-2-5 Timing chart of camera operation modes

9-2-5-1 Free running mode

The camera has the free running mode which the exposure and readout timing can be set by software command and controlled by an internal microprocessor. The free running mode has normal readout mode (in which the exposure time is longer than the 1 frame readout time) and electrical shutter mode (in which the exposure time is shorter than the 1 frame readout time). These readout modes are automatically switched depending on the exposure time setting.

Note

- Please contact to Hamamatsu subsidiary or local distributor for the detail of the timing information.

9-2-5-1-1 Normal readout mode

The normal readout mode is suitable for observation, monitoring, field of view and focus adjustment, and animation because it can operate with full resolution, which is faster than the video rate (30 fps).

In addition, the exposure time can be extended to collect more signals and increase the signal-to-noise ratio if the object is dark. In the normal readout mode, the exposure time is the same or longer than the 1 frame readout time. In this mode, the frame rate depends on the exposure time, and it becomes frame rate = 1/exposure time. The maximum exposure time is 10 s.

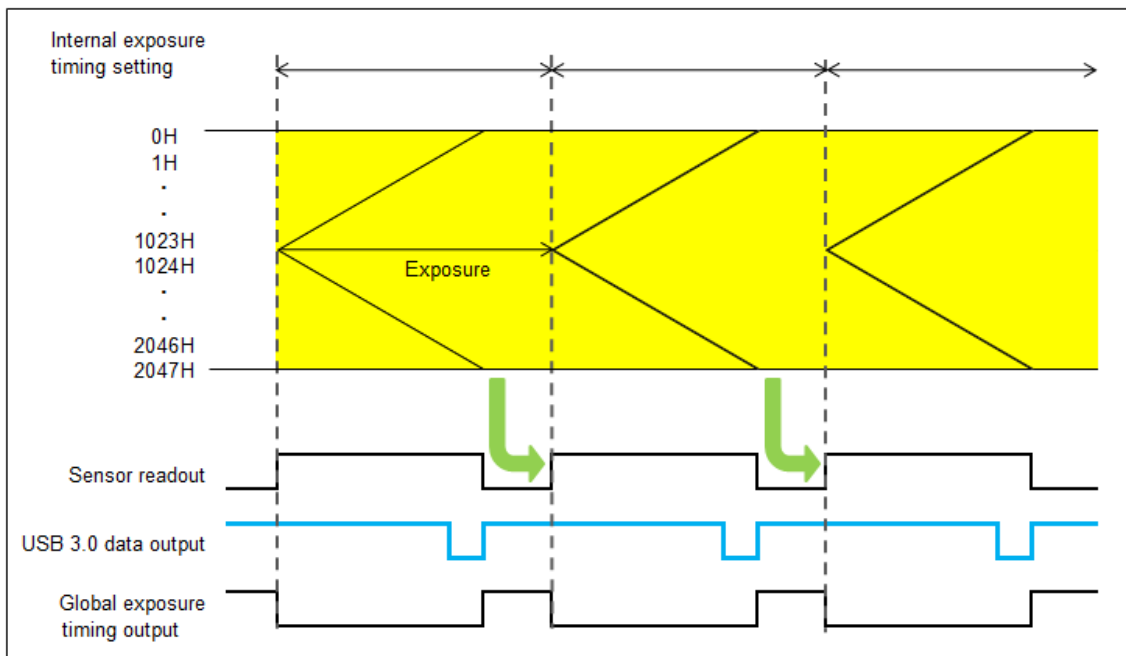

Figure 9-5

9-2-5-1-2 Electrical shutter mode

The electrical shutter mode is used to get a proper signal level when signal overflow happens due to too much input photons in normal readout mode. In this mode, the fastest frame rate is 30 fps at full resolution even when the exposure time is short.

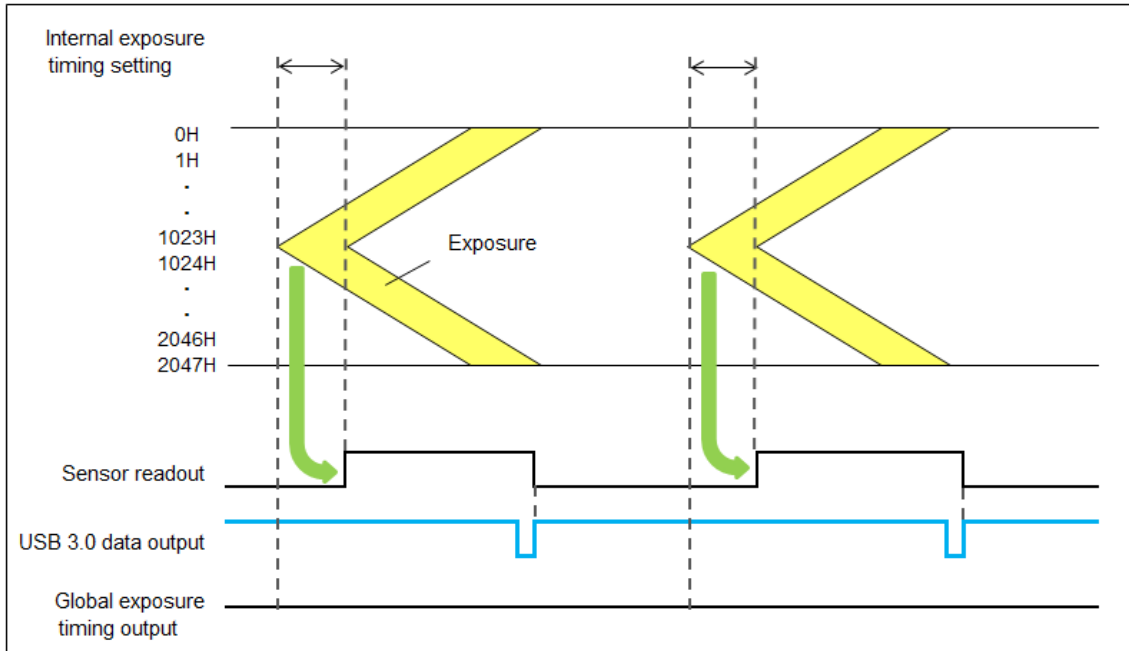

Figure 9-6

9-2-5-2 External trigger mode

The camera has various external trigger functions to synchronize the camera with the external equipment. In the external trigger mode, the external equipment becomes a master and the camera becomes a slave.

Note

- Please contact to Hamamatsu subsidiary or local distributor for the detail of the timing information.

9-2-5-2-1 Edge trigger mode

The edge trigger mode is used so that the exposure starts according to an external signal. Exposure time is set by software command. In this mode, the exposure of the first line begins on the edge (rising/falling) timing of the input trigger signal into the camera. (1023H and 1024H in the following figure) The exposure of the second line is begun after the readout time of one line passes (1022H and 1025H in the following figure), and the exposure is begun one by one for each line.

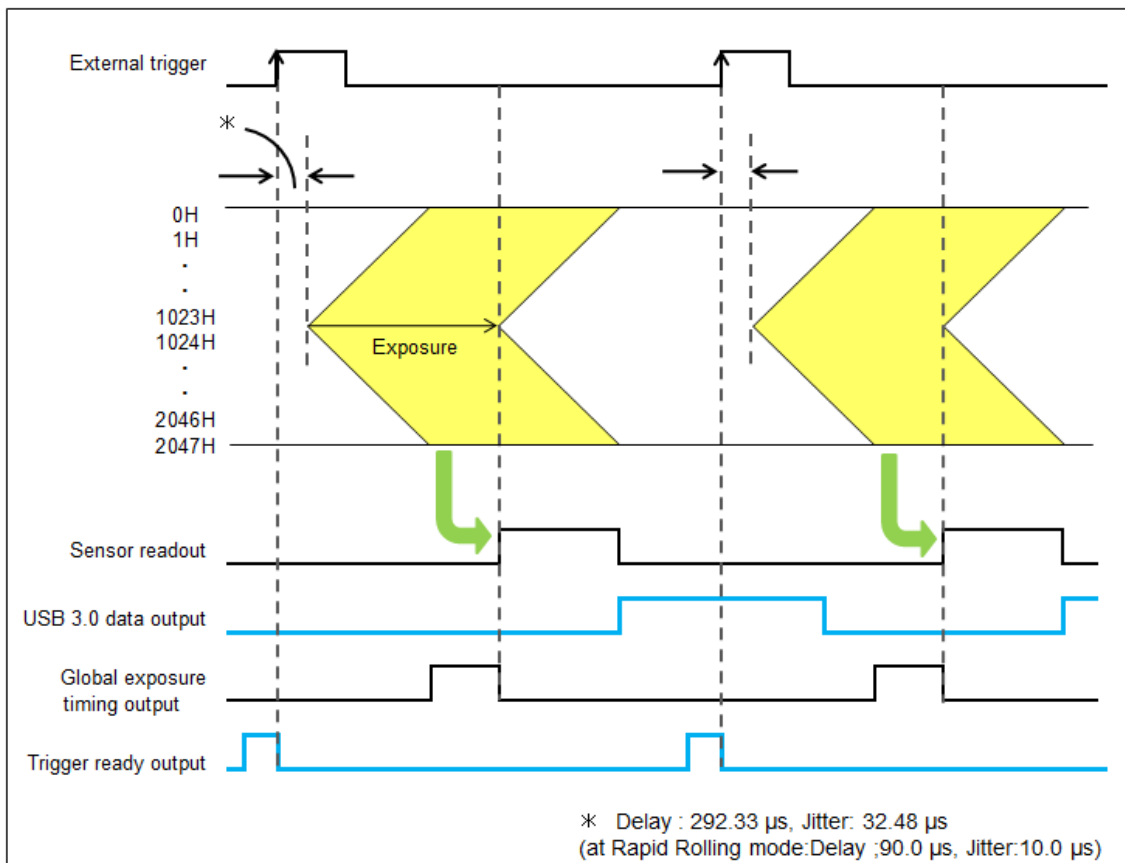

Figure 9-7 (Ex. rising edge)

9-2-5-2-2 Level trigger mode

The level trigger mode is used to control both exposure start timing and exposure time length by inputting external trigger pulses. In this mode, the camera starts exposure at the start of high or low period of the input trigger pulse and stops exposure at the end of high or low period of the input trigger pulse. The example below is for the trigger level High. The exposure of the first line begins when the trigger signal becomes High, and the exposure of the second line begins after the readout time of line one passes. Each exposure begins one by one for each line. The exposure of the first line is finished when the trigger signal becomes low, and signal readout is begun. The exposure time of each line is defined by the time that the input trigger is high. The minimum trigger pulse width is 1 ms + 50 μ s.

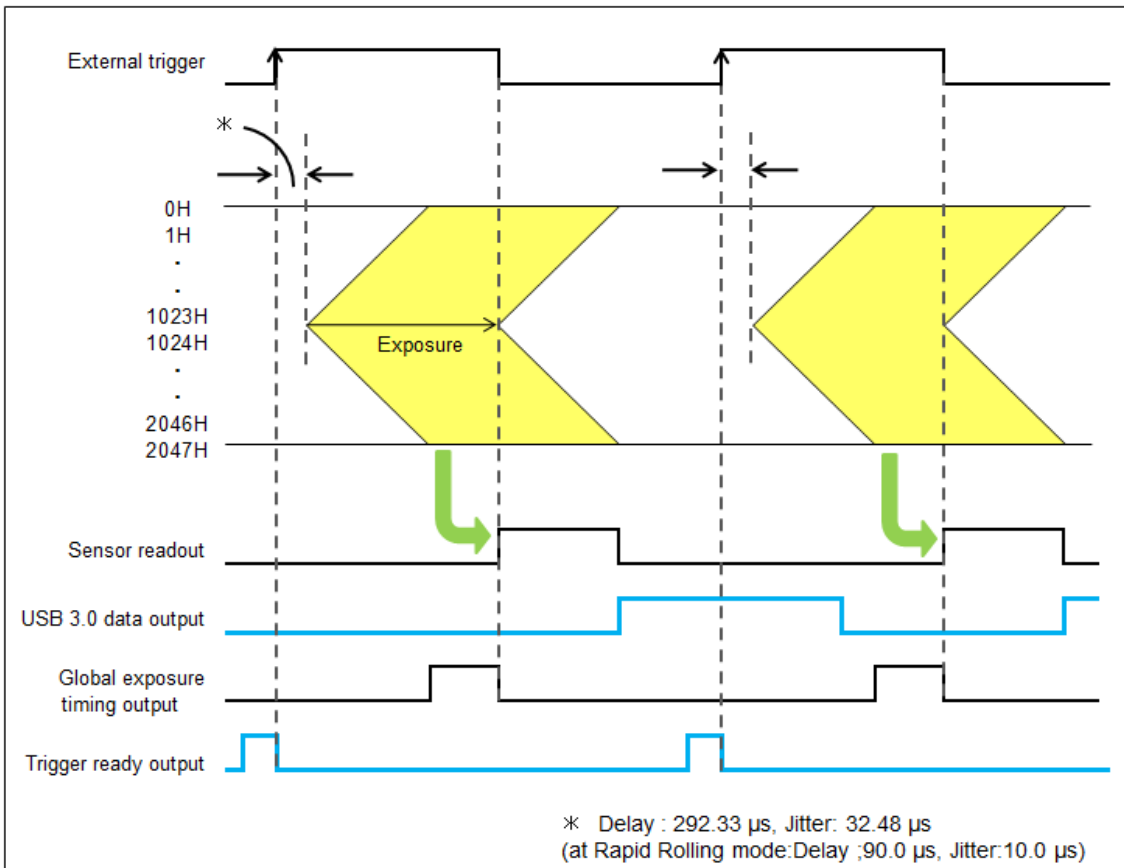

Figure 9-8 (Ex. rising edge)

9-2-5-2-3 Synchronous readout trigger mode

The synchronous readout trigger mode is used for continuous imaging when it is necessary to control the exposure start timing of each frame from an external source. It is useful for confocal microscopy. For example, when the camera is used with a spinning disk confocal microscope and the camera exposure time is synchronized to the spinning disk's rotation speed, it is possible to eliminate uneven illumination (called banding noise) caused by variation of the spinning disk rotation speed. Also, it is useful for securing as long exposure time as possible while controlling the exposure start timings by external trigger signals.

(1) Normal operation (when the trigger times is set as 1.)

The synchronous readout trigger mode is used for continuous imaging when it is necessary to control the exposure start timing of each frame from an outside source and also when it is necessary to secure as long exposure time as possible. In the synchronous readout trigger mode, the camera ends each exposure, starts the readout and also, at the same time, starts the next exposure at the edge of the input trigger signal (rising / falling edge). That is, the interval between the same edges of the input trigger becomes the exposure time.

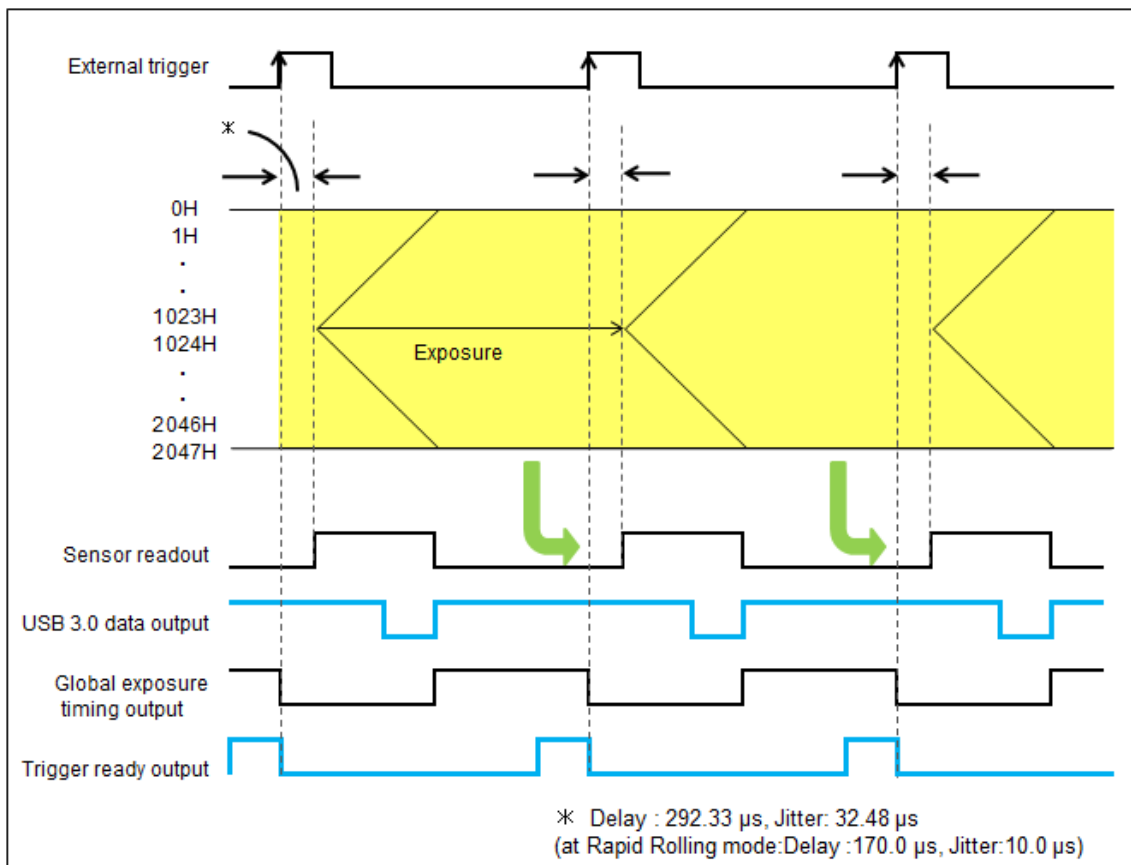

Figure 9-9 (Ex. rising edge)

(2) Trigger times

Also in the synchronous readout trigger mode, synchronous readout can be controlled by specifying, set by command, the number of timing pulses to determine the exposure time. The following figure shows the exposure timing when the Trigger Times is set as 3.

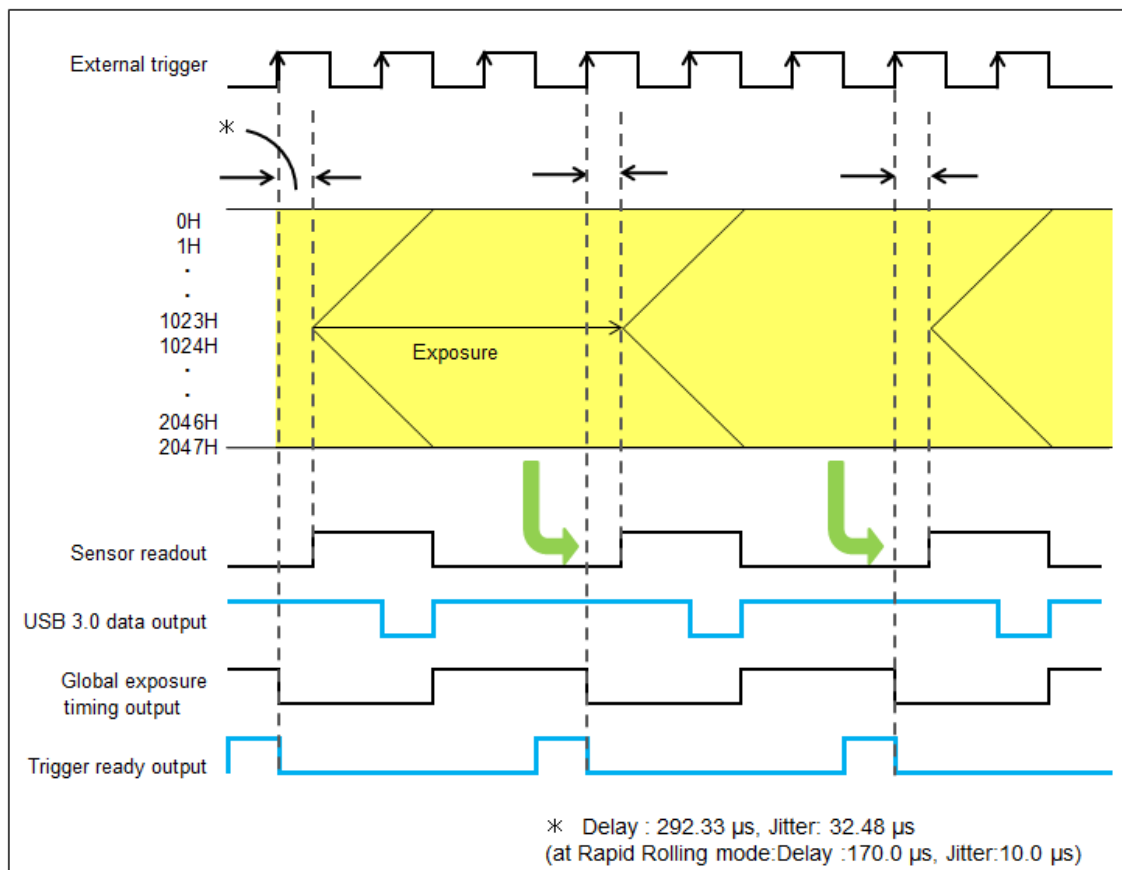

Figure 9-10 (Trigger Times)

9-2-5-2-4 Start trigger mode

The start trigger mode is to start operating the camera by a trigger input for a continuous imaging. It is useful to secure the frame rate as fast as possible when continuous image acquisition and not to sacrifice the exposure time. For example, when it is necessary to measure the phenomenon after stimulation, it is possible to start continuous image acquisition at the stimulation timing.

The start trigger mode is to start operating the camera by a trigger input for continuous imaging, and it works at the highest frame rate because it is operated in free running mode. In the start trigger mode, the camera starts exposure and switches to free running mode by the edge of an external trigger signal (rising / falling edge).

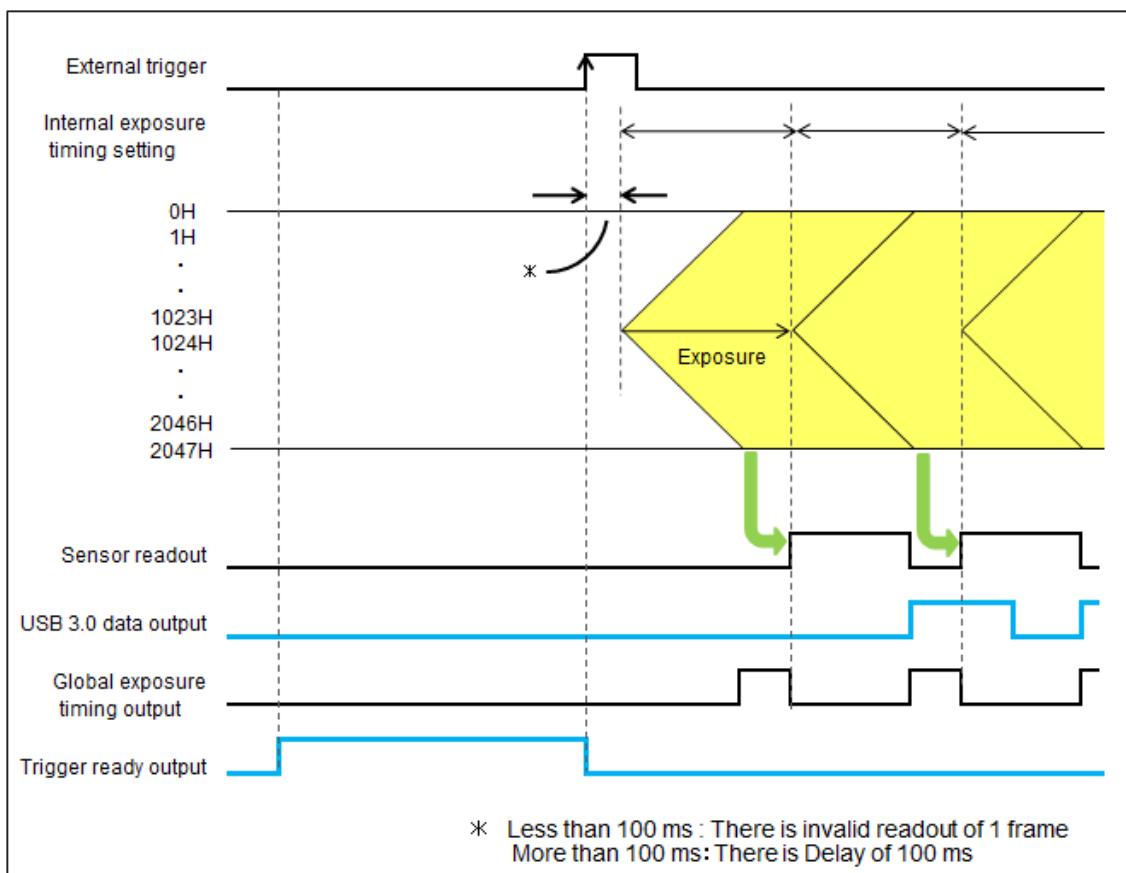

Figure 9-11 (Ex. rising edge)

9-2-5-2-5 External trigger delay function

In most cases when a delay between the laser pulse emission and the exposure start is needed, a delay unit is set between the laser and camera to control trigger timing. In each external trigger mode of the camera, the delay can be set to the trigger signal input to the camera by command. With this setting, a range of trigger can be arranged without a delay unit. The range for delay time is 0 μ s to 10 s (10 μ s steps).

9-2-5-3 Trigger output

The camera provides a range of trigger output signals to synchronize with an external instrument and the camera becomes the master and the external instrument becomes the slave. There are three different trigger output functions as follows. Also, it can output continuous High output (High output fixed) or continuous Low output (Low output fixed).

These three different trigger output functions can be selected by software command, and they are output from Timing out connector.

Note

- Please refer to Figure 9-5 to Figure 9-11 about details of each trigger output functions.

9-2-5-3-1 Global exposure timing output

It shows the global exposure timing where all lines expose at the same time. There is a case that one event is divided into two frames because the timing of the exposure in each line is different for the rolling shutter. However, by using the Global exposure timing output the global exposure becomes possible for the phenomenon that happens for this period. Global exposure timing output shows the period where all lines expose at the same time.

Note

- There is no output signal when the exposure time is less than the frame rate.

9-2-5-3-2 Programmable timing output

By using the programmable timing output, synchronizing external devices is simple. A system that needs simple timing signal does not require a delay unit or pulse generator. It is possible to program and output a pulse that has an optional pulse width and an optional delay time to the end of readout timing or Vsync. The setting range for delay time is 0 μ s to 10 s, and the setting range for pulse width is 10 μ s to 10 s.

The relation between the parameter which can be set with each reference signal, and an output signal becomes below.

Reference signal	Output signal
Read End	Camera outputs a pulse after certain delay, from the end of sensor readout. Also the pulse width can be set.
Vsync	Camera outputs a pulse after certain delay, from the beginning of readout. Also the pulse width can be set.

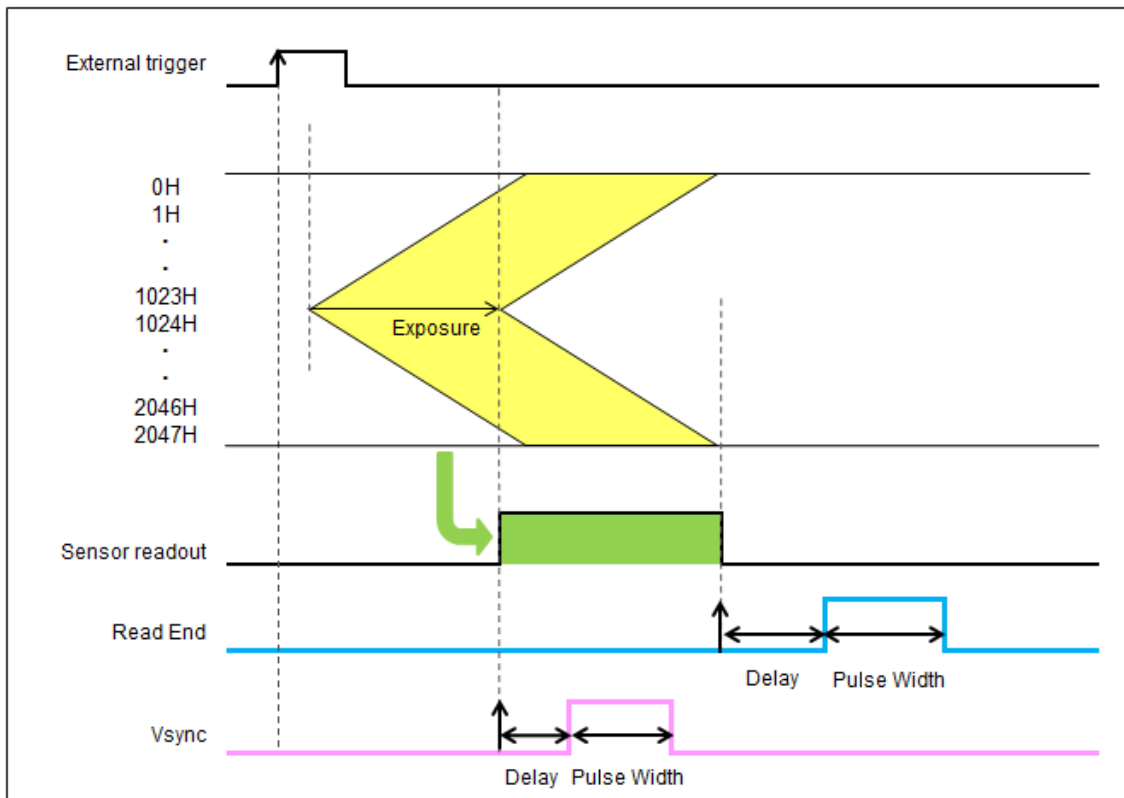

Figure 9-12

9-2-5-3-3 Trigger ready output

The trigger ready output is useful to make the frame intervals as short as possible in external trigger mode. For example, when the camera is working in the edge trigger mode, the next frame can start after the previous frame exposure is done. Thus, the camera cannot accept a trigger for the next frame during the exposure period. To reduce useless time to be as short as possible, it is necessary to know the period when the camera can accept a trigger for the next frame. The trigger ready output shows the trigger ready period when the camera can accept an external trigger in the external trigger mode.

9-2-5-3-4 Multi-channel sync

The camera provides 3 programmable timing outputs from Timing out connector 1, 2 and 3 in a sequence. For example, these programmable timing outputs are useful to control a light source and get a color image.

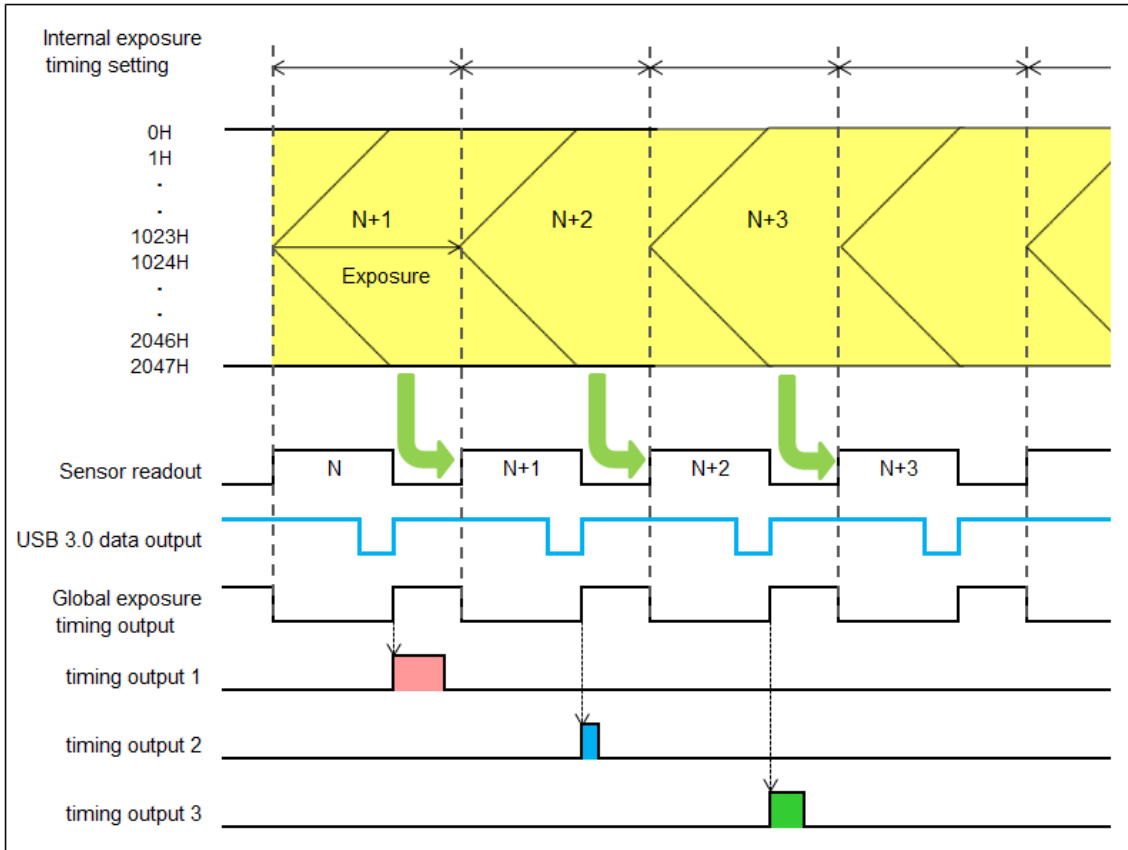

Figure 9-13

9-2-5-4 Global reset

Global reset function enables to reset the electric charge of all pixels at the same time. Then all pixels can start exposure at the same time.
Global reset can work with Edge trigger mode and Level trigger mode.

9-2-5-4-1 Edge trigger mode

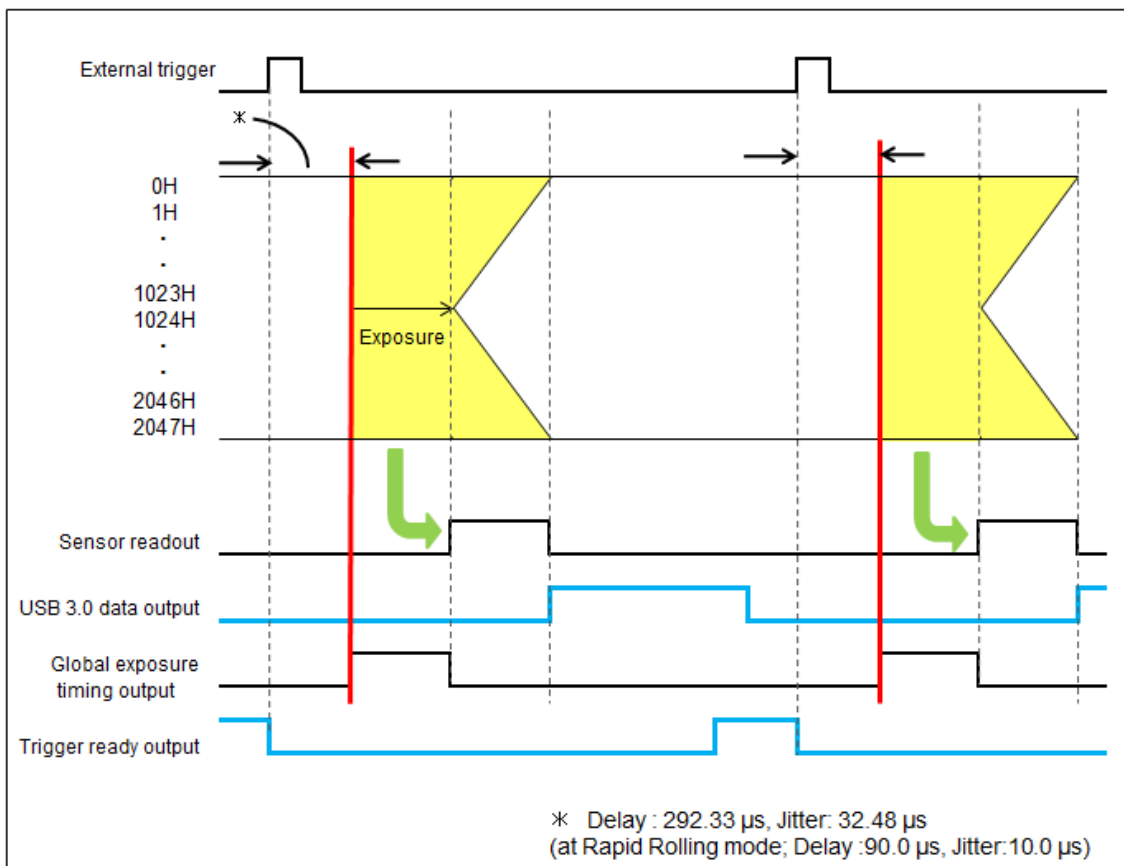

Figure 9-14

9-2-5-4-2 Level trigger mode

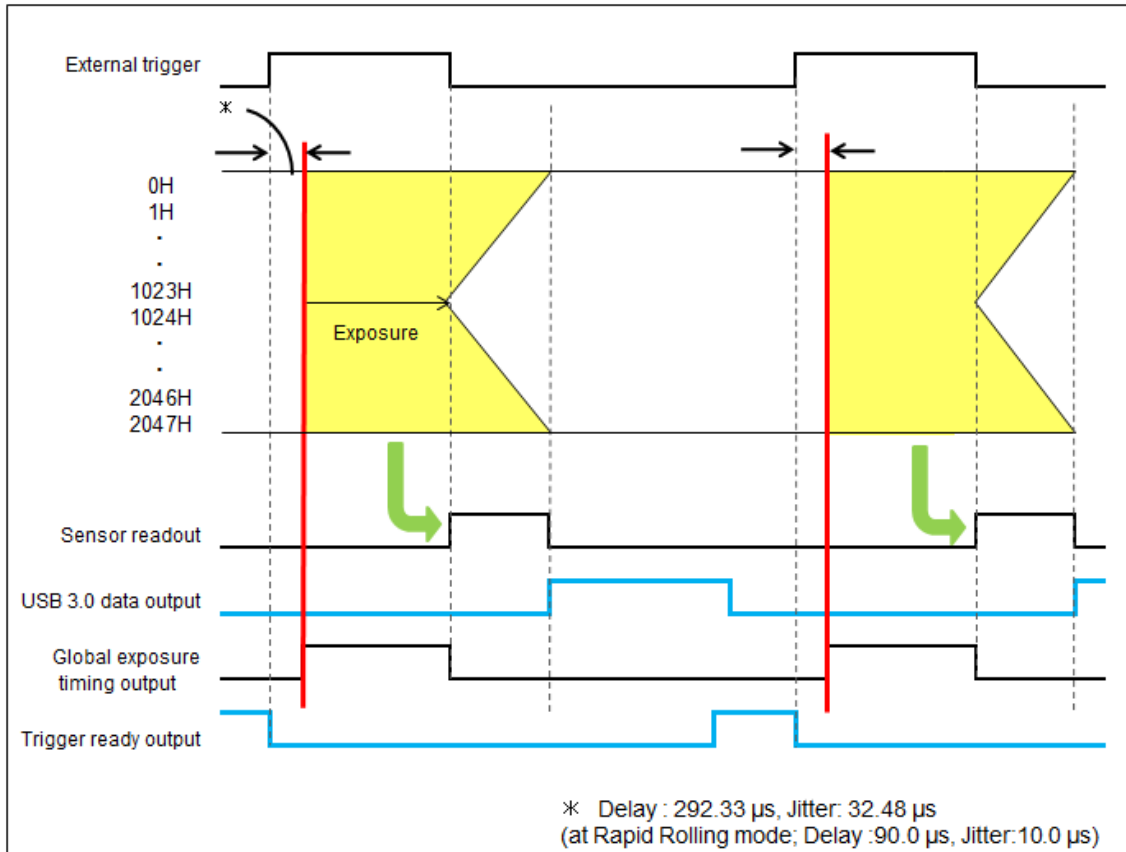

Figure 9-15

9-3 W-VIEW MODE

9-3-1 Readout method (scan mode)

The readout direction can be set for the top area and the bottom area independently in W-VIEW Mode. (Figure 9-16, 17, 18, 19)

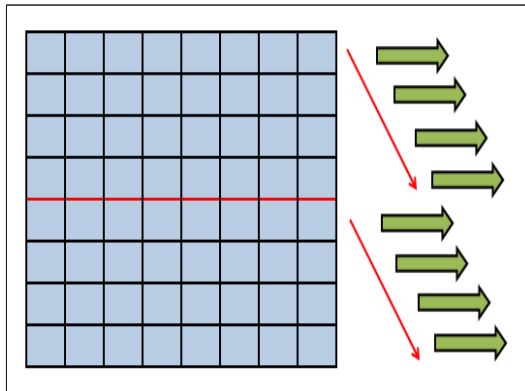

Figure 9-16 Top: top to center
/ Bottom: center to bottom

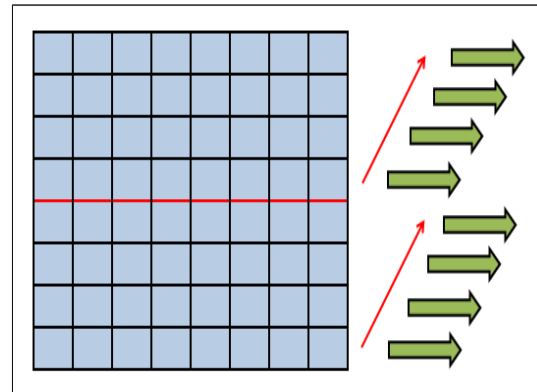

Figure 9-17 Top: center to top
/ Bottom: bottom to center

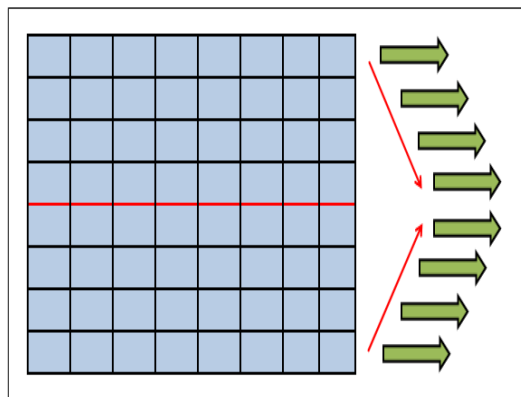

Figure 9-18 Top: top to center
/ Bottom: bottom to center

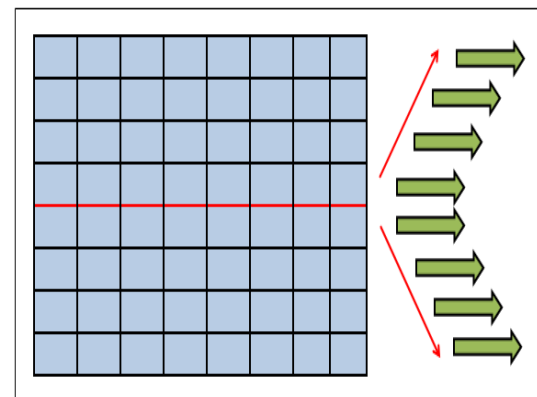

Figure 9-19 Top: center to top
/ Bottom: center to bottom

W-VIEW Mode supports Binning readout, Sub-array readout and Rapid rolling mode. In sub-array mode, the vertical position of sub-array readout can be set independently in the top and bottom areas.

The vertical height of sub-array readout is same in the both areas.

Note

- Please refer to 9-3-3 [Frame rate calculation] about the frame rate of each readout mode. Rapid Rolling mode is different from other modes.

9-3-2 Camera operation modes

W-VIEW Mode can work with Free running mode, Edge trigger mode, Level trigger mode, Synchronous readout trigger mode and Start trigger mode. The exposure time can be set independently for the top and bottom areas with Free running mode, Edge trigger mode and Start trigger mode.

Note

- Please refer to 9-3-5 [Timing chart of camera operation modes] about the detail of timing chart of these modes.

9-3-3 Frame rate calculation

The calculation formula of frame rate and the value of frame rate are as below.

■ Calculation formula

Vn = Number of vertical line (Size of the area of one side)
 Exp1 = 3 ms to 6 s
 1H = 32.4812×10^{-6}

Free running mode	$1/(Vn \times 1H)$
External trigger mode (Edge/Level)	$1/(Vn \times 1H + Exp1 + 1H \times 10)$
External trigger mode (Synchronous readout)	$1/(Vn \times 1H + 1H \times 18)$



- The Exp1 value has to be input to the calculation formula below in units of seconds.

■ Value of frame rate

(fps)

Horizontal width × Vertical width		Free running mode	External trigger mode (Edge/Level)	External trigger mode (Synchronous readout)
2048	1024	30	27	29
	512	60	50	58
	256	120	85	112
	128	240	133	210
	64	481	185	375
	32	962	229	615
	4	7696	289	1399

The calculation formula of frame rate and the value of frame rate for Rapid Rolling Mode are Shown in next page.

■ Calculation formula (Rapid Rolling Mode)

V_n = Number of vertical line (Size of the area of one side)
 $Exp1$ = 1 ms to 2 s
 $Exp2$ = 1.05 ms to 2 s
 $1H$ = 10×10^{-6}
 $int()$ = The decimal point is rounded down.



- The $Exp1$ and $Exp2$ values must be input to the calculation formula below in units of seconds.

	Binning	Horizontal width	Vertical width	Calculation formula
Free running mode	1×1	1024 1536 2048	---	$1/(int(V_n/1024/30/1H) \times 1H)$
	1×1	512	---	$1/(V_n \times 1H)$
	2×2 4×4	---	---	
External trigger mode (Edge trigger)	1×1	1024 1536 2048	$56 \leq V_n \leq 1024$	$1/(int(V_n/1024/30/1H) \times 1H)$
	1×1	1024 1536 2048	$4 \leq V_n \leq 52$	$1/(V_n \times 1H + 1H \times 10 + Exp1)$
	1×1	512	---	
	2×2 4×4	---	---	
External trigger mode (Level trigger)	1×1	1024 1536 2048	$56 \leq V_n \leq 1024$	$1/(int(V_n/1024/30/1H) \times 1H)$
	1×1	1024 1536 2048	$4 \leq V_n \leq 52$	$1/(V_n \times 1H + 1H \times 4 + Exp2)$
	1×1	512	---	
	2×2 4×4	---	---	
External trigger mode (Synchronous readout)	1×1	1024 1536 2048	$16 \leq V_n \leq 1024$	$1/(int(V_n/1024/30/1H) \times 1H)$
	1×1	64 1024 1536 2048	$4 \leq V_n \leq 12$	$1/(V_n \times 1H + 1H \times 18)$
	1×1	512	---	
	2×2 4×4	---	---	

Value of frame rate (Rapid Rolling Mode)

(fps)

	Horizontal width / Vertical width	1×1 (Normal readout)		Binning: 2×2 / 4×4
		1024 / 1536 / 2048	512	---
Free running mode	1024	30	97	97
	512	60	195	195
	256	120	390	390
	128	240	781	781
	64	480	1562	1562
	32	961	3125	3125
	4	7692	25 000	25 000
External trigger mode (Edge trigger)	1024	30	88	88
	512	60	160	160
	256	120	273	273
	128	240	420	420
	64	480	574	574
	32	704	704	704
	4	877	877	877
External trigger mode (Level trigger)	1024	30	88	88
	512	60	161	161
	256	120	273	273
	128	240	421	421
	64	480	578	578
	32	709	709	709
	4	884	884	884
External trigger mode (Synchronous readout)	1024	30	95	95
	512	60	188	188
	256	120	364	364
	128	240	684	684
	64	480	1219	1219
	32	961	2000	2000
	4	4545	4545	4545

Note

- The calculation formula and the frame rate value of Start trigger mode (External trigger mode) are same as the free running mode. About this mode, refer to 9-3-5-2 [Start trigger mode].

9-3-4 Configuring exposure time

The exposure time can be set independently for the top and bottom areas. The actual exposure time setting is defined by the following formula.

$$32.4812 \mu\text{s} \times \text{Exp2}$$

Exp1 = 3 ms to 6 s (at sub-array 129.99 μs to 6 s)

Exp2 = $\text{Exp1} \times 10^6 \div 32.4812 \mu\text{s}$ (round up at decimal point)

The actual exposure time setting for Rapid Rolling Mode is defined by the following formula.

$$10 \mu\text{s} \times \text{Exp2}$$

Exp1 = 1 ms to 2 s (at sub-array 40 μs to 2 s)

Exp2 = $\text{Exp1} \times 10^6 \div 10 \mu\text{s}$ (round up at decimal point)

Available setting range of the exposure time is the following.

Free running mode	3 ms to 6 s
	1 ms to 2 s (Rapid Rolling Mode)
Free running mode (at Sub-array)	129.99 μs^* to 6 s The same exposure time is set for the top and bottom areas when the exposure time is shorter than 3 ms .
	40 μs^* to 2 s (Rapid Rolling Mode) The same exposure time is set for the top and bottom areas when the exposure time is shorter than 1 ms.
External trigger mode The exposure time can be set independently for the top and bottom areas with edge trigger mode or start trigger mode.	3 ms to 6 s
	1 ms to 2 s (Rapid Rolling Mode)

Note

* 129.99 μs and 40 μs (Rapid Rolling Mode) for the Free running mode (at Sub-array) is the minimum exposure time when sub-array is set to 4 lines vertically. The minimum exposure time vary depend on vertical line number of sub-array setting.

9-3-5 Timing chart of camera operation modes

The timing chart of operation modes in W-VIEW Mode is shown. When different exposure time is set for the top and bottom areas, the end of exposure timing becomes the same.

9-3-5-1 Free running mode

Electrical shutter mode works for the half area whose exposure time is shorter than the other half area exposure in W-VIEW Mode. When the exposure time for the both areas are shorter than the frame readout time, electrical shutter mode works for the both halves areas.

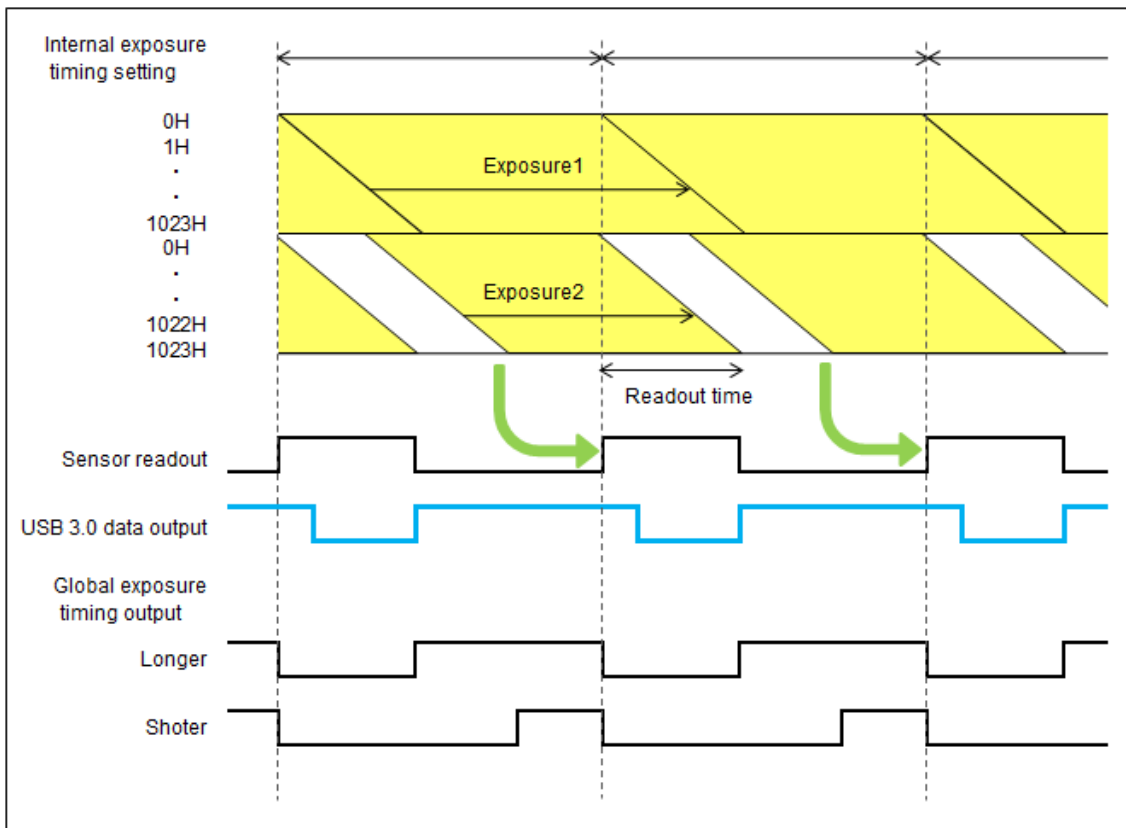

Figure 9-20

Note

- Please contact to Hamamatsu subsidiary or local distributor for the detail of the timing information.

9-3-5-2 External trigger mode

The exposure time can be set independently for the top and bottom areas with Edge trigger mode and Start trigger mode in W-VIEW Mode. The exposure time for both halves is the same with Level trigger mode and Synchronous readout trigger mode.

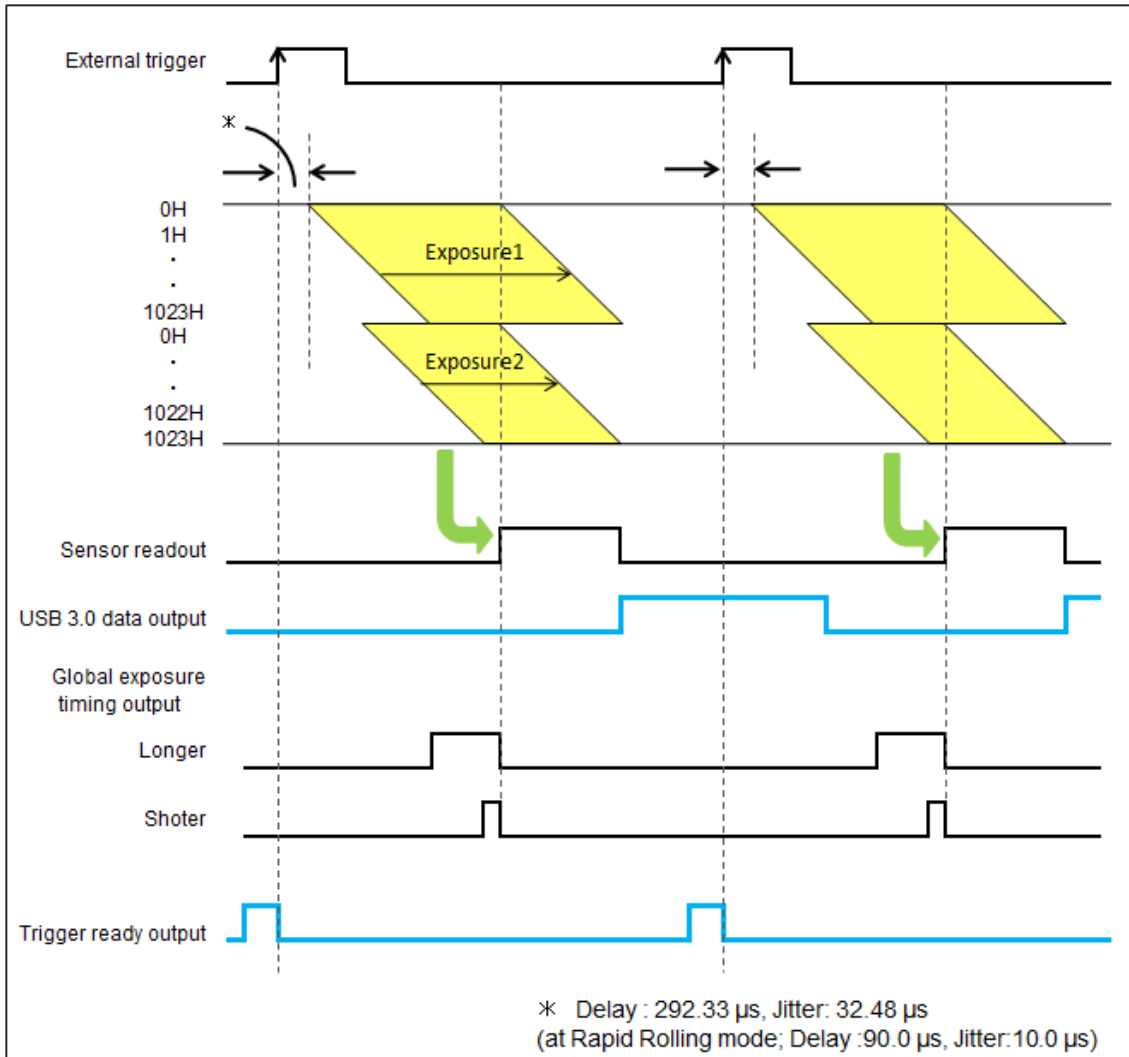

Figure 9-21 (Edge trigger mode)

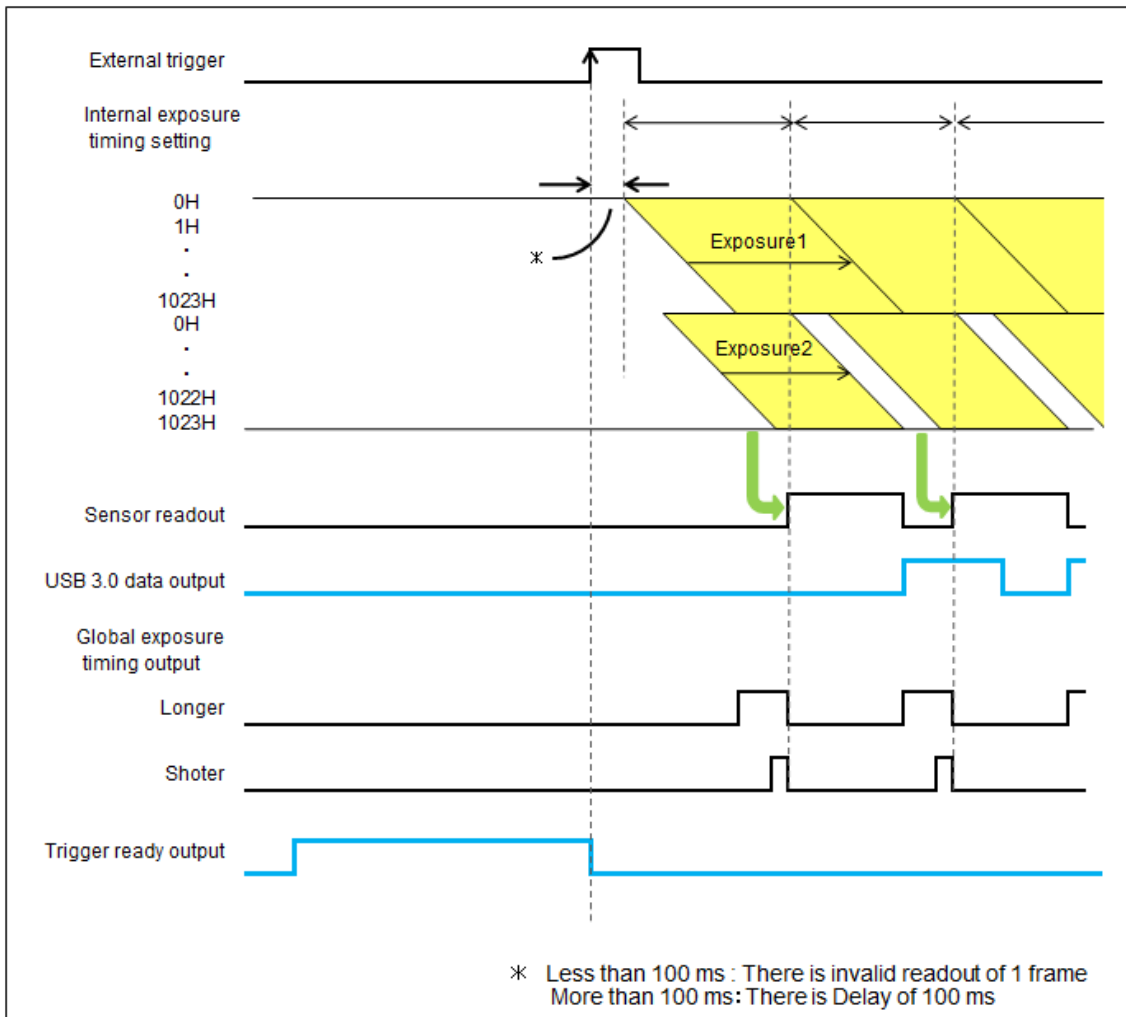

Figure 9-22 (Start trigger mode)

Note

- Please contact to Hamamatsu subsidiary or local distributor for the detail of the timing information.

9-3-5-3 Global exposure timing output

It shows the global exposure timing where all lines in the top area or the bottom area expose at the same time. When W-VIEW Mode, there are two kinds of global exposure timing output for the longer and the shorter exposure time. In this case, DCAM Configurator can only set either global exposure timing output for the longer or shorter exposure time.

Note

- There is no output signal when the exposure time for the both top and bottom area is shorter than the frame readout time.

9-3-5-4 Global reset

Global reset can work with Edge trigger mode and Level trigger mode in W-VIEW Mode. The exposure time for both halves is the same with Level trigger mode.

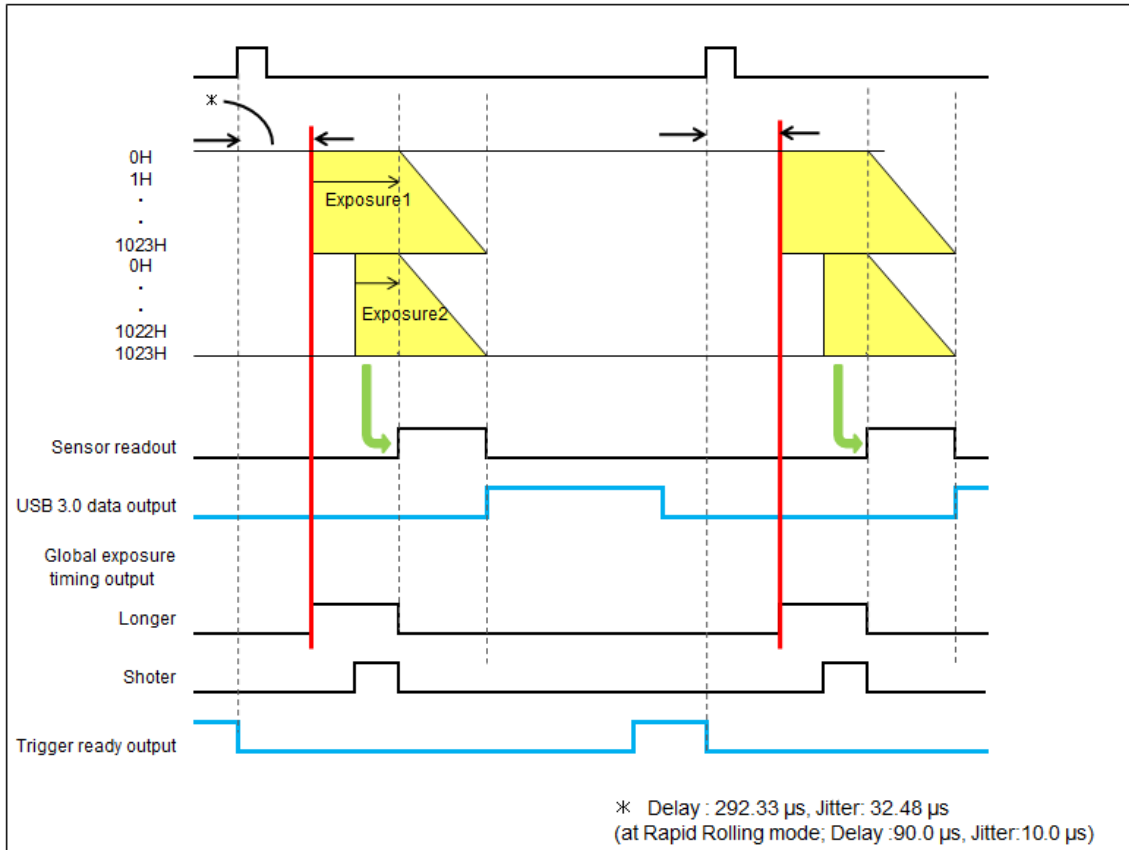

Figure 9-23 (Global reset edge trigger mode)

9-4 REAL-TIME CORRECTION FUNCTIONS

There are a few pixels in the CMOS image sensor that have slightly higher readout noise performance compared to surrounding pixels. The camera has real-time variant pixel correction features to improve image quality. The correction is performed in real-time without sacrificing the readout speed at all. This function can be turned ON and OFF. (Default is ON)

10. PRECAUTION WHEN USING THE CMOS IMAGE SENSOR

This camera uses the scientific CMOS image sensor. Careful attention must be paid to the following points when using the CMOS image sensor:

(1) White spot

Subjecting the CMOS image sensor to extended exposures may cause failure in part of the silicon wafer, resulting in white spots. Currently this phenomenon is not preventable. If the CMOS image sensor is at a fixed temperature, recurrence of the white spot increases proportionally with the exposure time, so this can be rectified with dark subtraction*. Cosmic ray may generate white spot.

* After acquiring an image using a certain exposure time is loaded, the CMOS image sensor is exposed to darkness for the same amount of time, and another image is obtained. After this, the difference between the images is determined, and the data for the dark portion of the original image is nullified.

(2) Folding distortion

A rough-edged flicker may be visible when imaging striped patterns, lines, and similar subject matter.

(3) Over light



CAUTION

- Be careful not to input too strong light such as high-energy laser into the CMOS image sensor because the CMOS image sensor may be damaged by over light.

11. MAINTENANCE

11-1 CARE

Perform cleaning of the camera with the dry soft cloth.



- Do not wipe with a damp cloth or unclean cloth.

Then, the glass window on the CMOS image sensor should be cleaned according to the following.

- (1) Blow the dust from the glass window with an air duster.
- (2) Moisten a lens cleaning paper with a little ethanol, and wipe over center area of the window, gently.



- Use Lens Cleaning Paper for cleaning of glass window in front of the CMOS image sensor.



- Use a plastic tweezers and take extra care not to scratch the glass window with the tweezers. Even with plastic tweezers, there is possibility to make scratch on the glass window in case tweezers touch it.



- Avoid touching the surrounding parts of image area when wiping the glass window.

- (3) Confirm whether dust is not left.

Attach the camera to an optics, and check if there is dust or not under the uniform light condition. If there is dust on the image, please clean the glass window again.

12. TROUBLESHOOTING

If an anomaly occurs, look up the possible causes in the following tables and, if necessary, report the details to a Hamamatsu subsidiary or your local distributor.

12-1 IMAGE IS NOT TRANSFERRED

Cause	Measures	Chapter
AC adapter or other cable is loose	Reconnect the cable	7
AC adapter or other cable is broken	Replace the cable	7
The correct command has not been sent to the camera	Recheck command	

12-2 ALTHOUGH IMAGES ARE TRANSFERRED

(1) Scratches or discoloration visible on the screen

Cause	Measures	Chapter
Lens is dirty	Wipe the lens	11

(2) Image is blurred

Cause	Measures	Chapter
Lens is not focused	Contact Hamamatsu subsidiary or local distributor	16
Condensation appear	Confirm the operating environmental conditions	13

(3) Only shadowed images are output

Cause	Measures	Chapter
Lens mount cap has been left on	Remove the cap	
Amount of light is too much or too low	Adjust amount of light	

(4) All screens overflow

Cause	Measures	Chapter
Too much amount of light	Reduce amount of light	
Contrast enhancement is too high	Reduce gain	

(5) Noise appears on the screen

Cause	Measures	Chapter
Exogenous noise	Find and remove cause	
Poor connection of internal connector	Contact Hamamatsu subsidiary or local distributor	16
Defective circuit system		

13. SPECIFICATIONS

13-1 CAMERA SPECIFICATIONS

(1) Electric specifications

Imaging device	Scientific CMOS image sensor	
Effective number of pixels	2048 (H) × 2048 (V)	
Cell size	6.5 μm (H) × 6.5 μm (V)	
Effective area	13.312 mm (H) × 13.312 mm (V)	
Full well capacity *1	30 000 electrons	
Cooling method	Peltier device + Forced air-cooled	
Cooling temperature	+ 10 °C (Ambient temperature: + 10 °C to + 30 °C)	
Conversion factor *1	0.46 electrons/count	
Digital output	16 bit	
Dark offset	100 counts(at Normal readout) 400 counts(at 2x2 Binning readout) 1600 counts(at 4x4 Binning readout)	
Sensor readout time	33 ms	
	10 ms (Rapid Rolling Mode)	
Readout speed (Frame rate)	at Full resolution	30 fps
	at 1024 lines at center position	60 fps
	at 8 lines at center position	7696 fps
	at Horizontal 512 pixels at 8 lines at center position	25 000 fps (Rapid Rolling Mode)
Readout mode	Normal readout mode	1×1
	Binning readout mode*2	2×2,4×4
	Sub-array readout mode	Configurable for each vertical 8 pixels and horizontal 512 pixels.
W-VIEW Mode	Binning readout mode*2	Digital binning 2x2,4x4
	Sub-array readout mode	Configurable for each vertical 4 pixels and horizontal 512 pixels. Configurable different value in the top and bottom areas.
	Readout direction	Top/bottom to center, or center to top/Bottom. Configurable different value in the top and bottom areas.

Readout noise * ¹	1.5 electrons r.m.s.	
	1.9 electrons r.m.s. (Rapid Rolling Mode)	
Dark current * ¹	0.6 electron/pixel/s (at Cooling temperature: + 10 °C)	
Dynamic range * ³	33 000 : 1	
Dark Signal Non-Uniformity (DSNU) * ¹	0.3 electrons r.m.s.	
Photo Response Non-Uniformity (PRNU) * ¹	15 000 electrons	0.6 % r.m.s.
	700 electrons	1.0 % r.m.s.
Linearity error* ¹	EMVA1288 standard	0.5 %
	< 500 electrons signal	0.3 %
Exposure time	Free running mode	3 ms to 10 s
		1 ms to 10 s (Rapid Rolling Mode)
	Free running mode / Sub-array mode	129.99 μ s to 10 s
		40 μ s to 10 s (Rapid Rolling Mode)
External trigger mode	3 ms to 10 s	
	1 ms to 10 s (Rapid Rolling Mode)	
Exposure time for W-VIEW Mode	Free running mode	3 ms to 6 s
		1 ms to 2 s (Rapid rolling mode)
	Free running mode / Sub-array mode	129.99 μ s to 6 s The same exposure time is set for the top and bottom areas when the exposure time is shorter than 3 ms
		40 μ s to 2 s (Rapid rolling mode) The same exposure time is set for the top and bottom areas when the exposure time is shorter than 1 ms
External trigger mode	3 ms to 6 s	
	1 ms to 2 s (Rapid rolling mode)	
External trigger input mode	Edge trigger / Global reset edge trigger Level trigger / Global reset level trigger Synchronous readout trigger Start trigger	
External trigger input polarity	Positive / Negative	
Trigger times (at Synchronous readout trigger)	1 to 4095 times(1 step)	
External trigger delay function	0 μ s to 10 s (10 μ s steps)	
External trigger input connector	SMA connector	
External trigger input level	3.3 V LVCMOS level	

External trigger output	Global exposure timing output Trigger ready output Programmable timing output 1 Programmable timing output 2 Programmable timing output 3 (Continuous High or Low output) Multi-channel Sync	
External trigger output polarity	Positive / Negative	
Programmable timing output	Delay	0 μ s to 10 s (1 μ s steps)
	Pulse width	1 μ s to 10 s (1 μ s steps)
External trigger output connector	SMA connector	
External trigger output level	3.3 V LVCMOS level	
Image processing function	Real-time offset correction Real-time gain correction Real-time defect pixel correction (Default On/Off)	
Interface	USB 3.0 Super Speed	
Interface connector	USB 3.0 MicroB type	
Lens mount	C11440-42U30: C-mount	
	C11440-42U31: F-mount	

*1 Typical value

*2 Digital binning processing in the camera.

*3 Calculated from the ratio of the full well capacity and the readout noise.

(2) Power supply specifications

Camera	Input power supply	DC12 V
	Power consumption	26 W
AC adapter	Input power supply	AC100 V to AC240 V 50 Hz/60 Hz
	Typical output	DC12 V
	Power consumption	75 VA

Note

- Fluctuations of input power supply voltages are not to exceed $\pm 10\%$ of the nominal voltage.

(3) Operating environment

Ambient operating temperature	0 °C to + 40 °C
Ambient storage temperature	-10 °C to + 50 °C
Ambient operating humidity	30 % to 80 %, no condensation
Ambient storage humidity	Less than 90 %, no condensation
Place of operating	Indoor, altitude up to 2000 m

(4) Dimensional outline and weight

Dimensional outline	85 mm (W) × 85.5 mm (H) × 120.5 mm (D)	
Weight	Camera	Approx. 1.1 kg
	AC adapter + power supply cord	Approx. 1.0 kg

Note

• Please see 14. [DIMENSIONAL OUTLINES] for detail of dimensions.

(5) Applicable standards

EMC	EN61326-1: 2013 Class A
-----	-------------------------

13-2 SPECTRAL RESPONSE CHARACTERISTICS(TYP.)

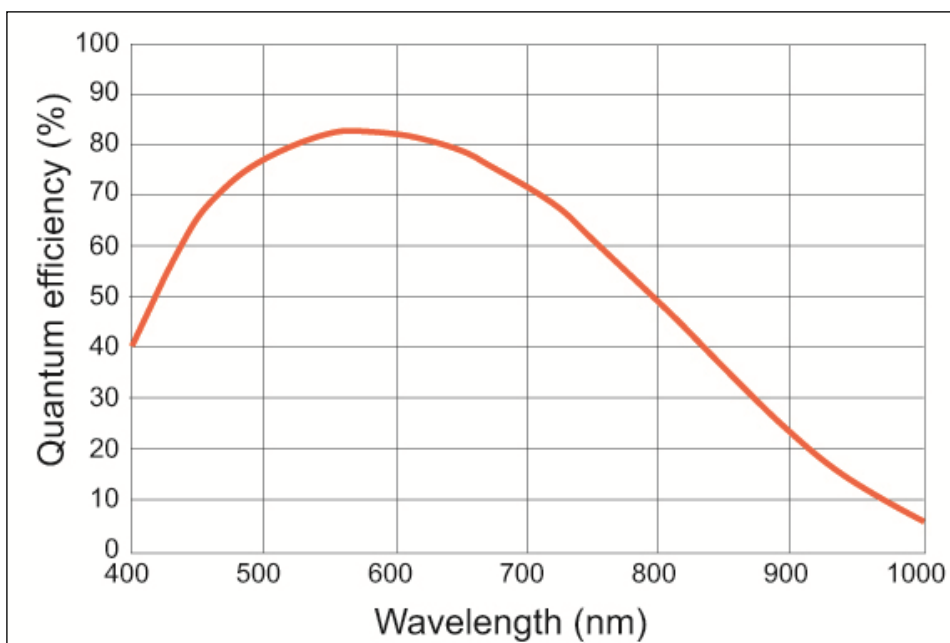

Figure 13-1

15. WARRANTY

Hamamatsu Photonics have fully inspected this camera and checked that its performance conforms to specifications. In the unlikely event of a breakdown or other malfunction, contact a Hamamatsu subsidiary or your local distributor.

15-1 BASIC WARRANTY

- (1) Unless otherwise stated by Hamamatsu subsidiary or local distributor, this camera is under warranty for 24 months from the delivery date.
 - Degradation with cosmic rays, the radiation (X-rays, gamma rays, UV light, etc.) of the CMOS image sensor is excepted.
- (2) The warranty only covers defects in the materials and manufacturing of the camera. You may be liable for repairs during the warranty period in the event of a natural disaster or if you handle the camera contrary to the instructions in this manual, use it without due caution, or try to modify it.
- (3) We will repair the camera or replace it, subject to availability, free of charge within the terms of the warranty.

15-2 REPAIRS

- (1) If you notice anything wrong with the camera, confirm whether or not it is malfunctioning by referring to the TROUBLESHOOTING in this instruction manual. You must first clarify the symptoms in order to avoid any misunderstanding or error.
- (2) If you have any trouble or are unclear about anything, contact a Hamamatsu subsidiary or your local distributor giving the product name, serial number and details of the problem. If Hamamatsu Photonics consider the problem to be a malfunction, we will decide whether dispatch an engineer or have the camera returned to us for repairs.

16. CONTACT INFORMATION

Manufacturer

HAMAMATSU PHOTONICS K. K., Systems Division

812 Joko-cho, Higashi-ku, Hamamatsu City, Shizuoka Pref., 431-3196, Japan
Telephone (81) 53-431-0124, Fax: (81) 53-435-1574
E-mail: export@sys.hpk.co.jp

Local contact information worldwide can be found at:

www.hamamatsu.com

- The contents of this manual are subject to change without notice.
- The unauthorized duplication or distribution of all or part of this manual is strictly prohibited.
- If one of the following is found, please contact Hamamatsu. (refer to the local contact information).
 - Contents of the manual are illegible, incorrect or missing.
 - Pages of the manual are missing or in the wrong order.
 - The manual is unclean.