

*User Manual
FieldMaxII-TOP™
Laser Power/Energy Meter*



User Manual
FieldMaxII-TOP
Laser Power/Energy Meter



27650 SW 95th Ave.
Wilsonville, OR 97070

This document is copyrighted with all rights reserved. Under the copyright laws, this document may not be copied in whole or in part or reproduced in any other media without the express written permission of Coherent, Inc. Permitted copies must carry the same proprietary and copyright notices as were affixed to the original. This exception does not allow copies to be made for others, whether or not sold, but all the material purchased may be sold, given, or loaned to another person. Under the law, copying includes translation into another language.

Coherent, the Coherent Logo, and FieldMaxII are trademarks or registered trademarks of Coherent, Inc. All other trademarks or registered trademarks are the property of their respective owners.

Patents referenced in this user manual were active as of the printing date of the manual (see last page for date). The patents referenced herein may have expired. You are advised to check to see if the patents are still active: <http://portal.uspto.gov/external/portal/pair>.

Every effort has been made to ensure that the data given in this document is accurate. The information, figures, tables, specifications and schematics contained herein are subject to change without notice. Coherent makes no warranty or representation, either expressed or implied with respect to this document. In no event will Coherent be liable for any direct, indirect, special, incidental or consequential damages resulting from any defects in its documentation.

Technical Support

In the US:

Should you experience any difficulties with your laser or need any technical information, please visit our website: www.Coherent.com. Additional support can be obtained by contacting our Technical Support Hotline at 1.800.367.7890 (1.408.764.4557 outside the U.S.), or e-mail Product.Support@Coherent.com. Telephone coverage is available around the clock (except U.S. holidays and company shutdowns).

If you call outside our office hours, your call will be taken by our answering system and will be returned when the office reopens.

If there are technical difficulties with your laser that cannot be resolved by support mechanisms outlined above, e-mail, or telephone Coherent Technical Support with a description of the problem and the corrective steps attempted. When communicating with our Technical Support Department via the web or telephone, the Support Engineer responding to your request will require the model and Laser Head serial number of your laser system.

Outside the US:

If you are located outside the U.S., visit our website for technical assistance or contact our local service representative. Representative phone numbers and addresses can be found on the Coherent website: www.Coherent.com.

Coherent provides telephone and web technical assistance as a service to its customers and assumes no liability thereby for any injury or damage that may occur contemporaneous with such services. These support services do not affect, under any circumstances, the terms of any warranty agreement between Coherent and the buyer. Operation of any Coherent laser with any of its interlocks defeated is always at the operator's own risk

TABLE OF CONTENTS

Signal Words and Symbols in this Manual	vii
Signal Words	vii
Symbols	viii
Preface	ix
RoHS Compliance	ix
Software Installation	ix
Export Control Laws Compliance	ix
Publication Updates	ix
Section One: Safety	1-1
Waste Electrical and Electronic Equipment (WEEE, 2002)	1-2
Declaration of Conformity	1-2
Section Two: Quick Start	2-1
Measuring Average Power With a Pyroelectric Sensor	2-2
Measuring Power With a Thermopile or Optical Sensor	2-3
Measuring Energy With a Pyroelectric Sensor	2-4
Measuring Energy With a Thermopile Sensor	2-5
Section Three: Description	3-1
Front Panel	3-2
Buttons	3-2
Display	3-3
Right Side Panel	3-4
USB Connector	3-5
Sensor Connector	3-5
Left Side Panel	3-5
Analog Out Connector	3-5
Power Jack Connector	3-5
Battery Replacement	3-5
Battery Directive	3-6
AC Adapter	3-6
Section Four: Operation	4-1
Tuning Mode	4-1
Tuning Needles	4-2
Zone Indicator Bars	4-2
Annunciators	4-3
Temperature	4-4
TRIG	4-4
AUTO	4-4
Range Hint	4-4
AVG	4-4
ATTEN	4-4

RMT	4-4
Battery	4-5
Fault Displays	4-5
Invalid and not Available Data Conditions	4-5
Invalid Data	4-6
Not Available Data	4-6
Setup Parameters	4-6
Setup/Local	4-6
Stat	4-7
Wave	4-8
Area	4-8
Area Correction and Zeroing	4-9
Avg	4-9
Atten	4-10
Trig	4-10
Button Functions	4-11
J/W	4-11
Auto	4-11
Hz	4-11
Zero	4-11
Power Switch and Backlight Toggle Button	4-12
Up and Down Arrows	4-12
Left and Right Arrows	4-12
Statistics Mode	4-12
Invalid Data	4-13
Energy and Power Measurements	4-13
Measurement Display and Range Selection	4-14
Pyroelectric-Specific Information	4-16
Internal Triggering Mode	4-16
Hz Display Mode	4-17
Manual Ranging Mode	4-17
Thermopile- and Optical-Specific Information	4-18
Auto vs. Manual Ranging Mode	4-18
Zeroing	4-18
Section Five: Special Topics	5-1
Trigger States and the Trigger Annunciator	5-1
Pulsed Thermopile Joules Mode	5-2
Pyroelectric Watts Mode	5-2
Negative Power Display	5-3
Digital Tuning Feature Use in Statistics Mode	5-4
USB Driver Installation	5-4
Section Six: Host Interface	6-1
Overview	6-1

Section Seven: Calibration and Warranty 7-1

 Calibration 7-1

 Coherent Calibration Facilities and Capabilities 7-1

 Limited Warranty 7-2

 Extended Warranty..... 7-2

 Warranty Limitations 7-3

 Obtaining Service 7-3

 Product Shipping Instructions..... 7-4

Appendix A: Specifications..... A-1

Index Index-1

LIST OF FIGURES

1-1. Waste Electrical and Electronic Equipment Label..... 1-2

2-1. Measuring Average Power With a Pyroelectric Sensor 2-2

2-2. Measuring Power With a Thermopile or Optical Sensor 2-3

2-3. Measuring Energy With a Pyroelectric Sensor 2-4

2-4. Measuring Energy With a Thermopile Sensor 2-5

3-1. Front Panel 3-2

3-2. LCD Display 3-3

3-3. Right Side Panel..... 3-4

3-4. Left Side Panel..... 3-5

3-5. Optional Alkaline Battery Replacement 3-6

4-1. Location of Tuning Needles and Zone Indicator Bars 4-1

4-2. Current Scale Mid-Range 4-2

4-3. Zone Indicator Bars 4-2

4-4. Comparison of Zone Indicator Bars to Full Scale Measurement..... 4-3

4-5. Tuning Mode Example - Full Scale 4-3

4-6. Internal Trigger Threshold 4-17

4-7. Auto Ranging 4-18

5-1. Measuring Energy - Pulsed Thermopile Joules Mode 5-2

5-2. Burst Power..... 5-3

5-3. Burst Power Limitations 5-3

LIST OF TABLES

3-1.	Batteries Contained in this Product	3-6
4-1.	Fault Codes	4-5
4-2.	Numeric Display Information	4-14
4-3.	Full Scale Range Settings - Joules Mode.....	4-15
4-4.	Full Scale Range Settings - Watts Mode.....	4-15
7-1.	Coherent Service Centers.....	7-4
A-1.	Specifications.....	A-1

Signal Words and Symbols in this Manual

This documentation may contain sections in which particular hazards are defined or special attention is drawn to particular conditions. These sections are indicated with signal words in accordance with ANSI Z-535.6 and safety symbols (pictorial hazard alerts) in accordance with ANSI Z-535.3 and ISO 7010.

Signal Words

Four signal words are used in this documentation: **DANGER**, **WARNING**, **CAUTION** and **NOTICE**.

The signal words **DANGER**, **WARNING** and **CAUTION** designate the degree or level of hazard when there is the risk of injury:

DANGER!

Indicates a hazardous situation that, if not avoided, will result in death or serious injury. This signal word is to be limited to the most extreme situations.

WARNING!

Indicates a hazardous situation that, if not avoided, could result in death or serious injury.

CAUTION!

Indicates a hazardous situation that, if not avoided, could result in minor or moderate injury.

The signal word “**NOTICE**” is used when there is the risk of property damage:

NOTICE!

Indicates information considered important, but not hazard-related.

Messages relating to hazards that could result in both personal injury and property damage are considered safety messages and not property damage messages.

Symbols

The signal words **DANGER**, **WARNING**, and **CAUTION** are always emphasized with a safety symbol that indicates a special hazard, regardless of the hazard level:



This symbol is intended to alert the operator to the presence of important operating and maintenance instructions.



This symbol is intended to alert the operator to the danger of exposure to hazardous visible and invisible laser radiation.



This symbol is intended to alert the operator to the presence of dangerous voltages within the product enclosure that may be of sufficient magnitude to constitute a risk of electric shock.



This symbol is intended to alert the operator to the danger of Electro-Static Discharge (ESD) susceptibility.



This symbol is intended to alert the operator to the danger of crushing injury.



This symbol is intended to alert the operator to the danger of a lifting hazard.

Preface

This manual contains user information for the FieldMaxII-TOP™ laser power/energy meter.

RoHS Compliance

This Coherent product is RoHS compliant.

Software Installation

For complete software installation instructions, refer to the *FieldMaxII Software Installation and Quick Start Guide* (1176436)—inside the CD case that shipped with your product.

If that document is unavailable, insert the FieldMaxII CD into your CD-ROM drive. If Autorun is enabled on your system, installation will start automatically; otherwise, select Run from the Start menu and then type **D:\Setup.exe** (substitute the appropriate letter of your CD-ROM drive for **D**).

Export Control Laws Compliance

It is the policy of Coherent to comply strictly with U.S. export control laws.

Export and re-export of lasers manufactured by Coherent are subject to U.S. Export Administration Regulations, which are administered by the Commerce Department. In addition, shipments of certain components are regulated by the State Department under the International Traffic in Arms Regulations.

The applicable restrictions vary depending on the specific product involved and its destination. In some cases, U.S. law requires that U.S. Government approval be obtained prior to resale, export or re-export of certain articles. When there is uncertainty about the obligations imposed by U.S. law, clarification must be obtained from Coherent or an appropriate U.S. Government agency.

Products manufactured in the European Union, Singapore, Malaysia, Thailand: These commodities, technology, or software are subject to local export regulations and local laws. Diversion contrary to local law is prohibited. The use, sale, re-export, or re-transfer directly or indirectly in any prohibited activities are strictly prohibited.

Publication Updates

To view information that may have been added or changed since this publication went to print, connect to www.Coherent.com.

SECTION ONE: SAFETY

Carefully review the following safety information to avoid personal injury and to prevent damage to this meter or any sensor connected to it. Except for replaceable batteries—discussed under “Battery Replacement” (p. 3-5)—there are no user-serviceable parts in the FieldMaxII-TOP meter. For service information, refer to “Obtaining Service” (p. 7-3).



WARNING!

Use only the power cord specified for the meter. The grounding conductor of the cord must be connected to earth ground.



WARNING!

Do not operate the meter if its panels are removed or any of the interior circuitry is exposed.



WARNING!

Do not operate the meter in wet or damp conditions, or in an explosive atmosphere.



NOTICE!

Operate the meter only within the specified voltage range.



NOTICE!

Do not apply a voltage outside the specified range of the input connections.



Waste Electrical and Electronic Equipment (WEEE, 2002)

NOTICE!

Do not operate the meter if there are suspected failures. Refer damaged units to qualified Coherent service personnel.

The European Waste Electrical and Electronic Equipment (WEEE) Directive (2002/96/EC) is represented by a crossed-out garbage container label. The purpose of this directive is to minimize the disposal of WEEE as unsorted municipal waste and to facilitate its separate collection.

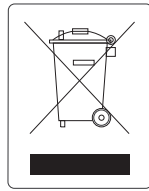

Figure 1-1. Waste Electrical and Electronic Equipment Label

Declaration of Conformity

Declaration of Conformity certificates are available upon request.

SECTION TWO: QUICK START

This section presents a series of “mini-tutorials” that explains how to connect a sensor to your FieldMaxII-TOP meter and begin taking measurements within minutes. For in-depth information about the procedures introduced in this section, refer to “Section Four: Operation” (p. 4-1).

In this section:

- Measuring average power with a pyroelectric sensor (p. 2-2)
- Measuring power with a thermopile or optical sensor (p. 2-3)
- Measuring energy with a pyroelectric sensor (p. 2-4)
- Measuring energy with a thermopile sensor (p. 2-5)



WARNING!

Follow all laser safety procedures. The laser must be blocked or switched OFF before beginning any of the procedures described in this section.



WARNING!

Power to the FieldMaxII-TOP instrument must be OFF before beginning any of the procedures described in this section.



NOTICE!

Do not exceed the power/energy density limits of the sensor.

Measuring Average Power With a Pyroelectric Sensor

The following figure shows how to set up a pyroelectric sensor to take an average power measurement.

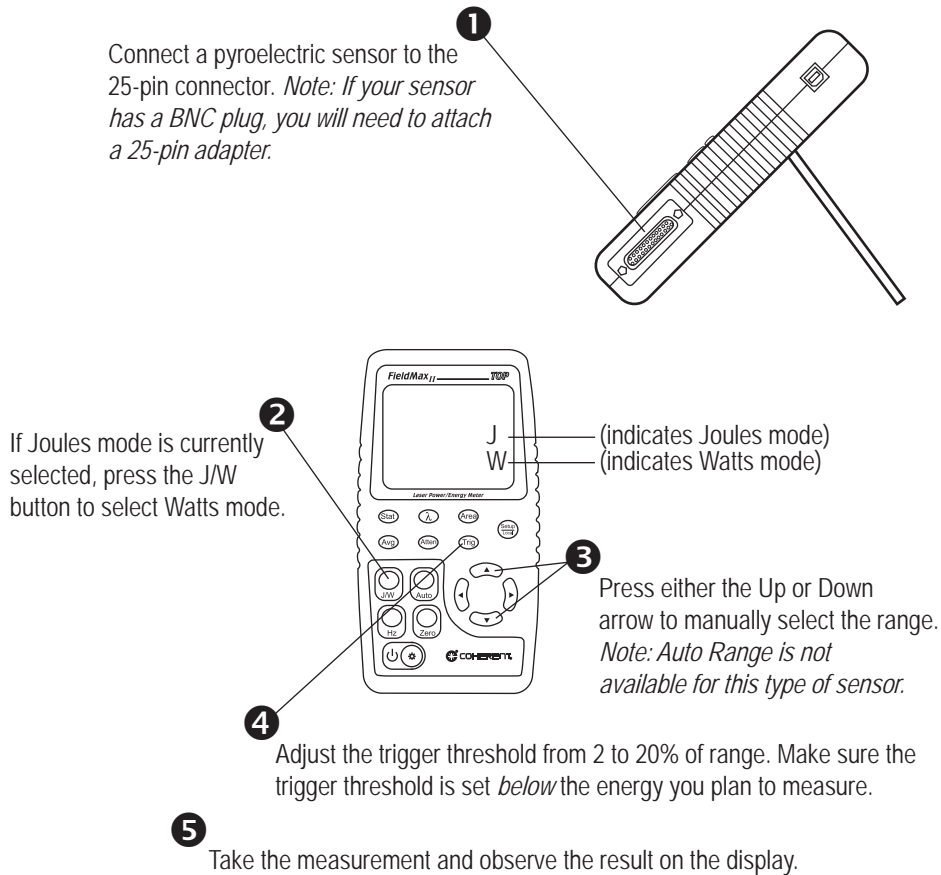

Figure 2-1. Measuring Average Power With a Pyroelectric Sensor

Measuring Power With a Thermopile or Optical Sensor

The following figure describes how to take a power measurement using a thermopile or optical sensor.

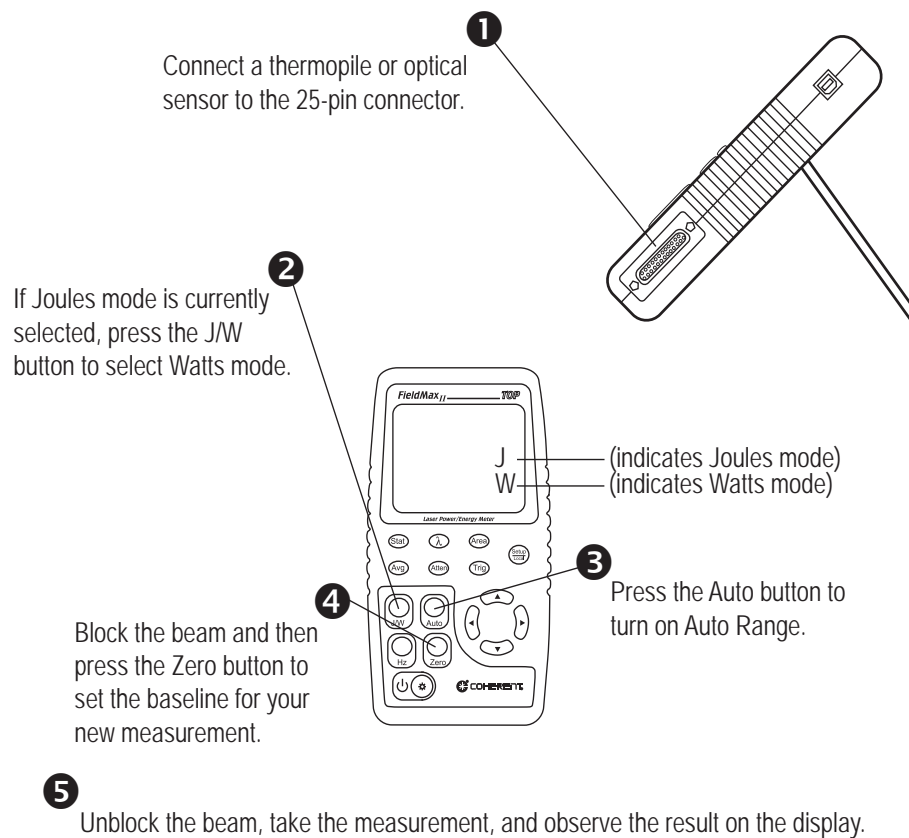

Figure 2-2. Measuring Power With a Thermopile or Optical Sensor

Measuring Energy With a Pyroelectric Sensor

The following figure outlines how to set up a pyroelectric sensor to take an energy measurement.

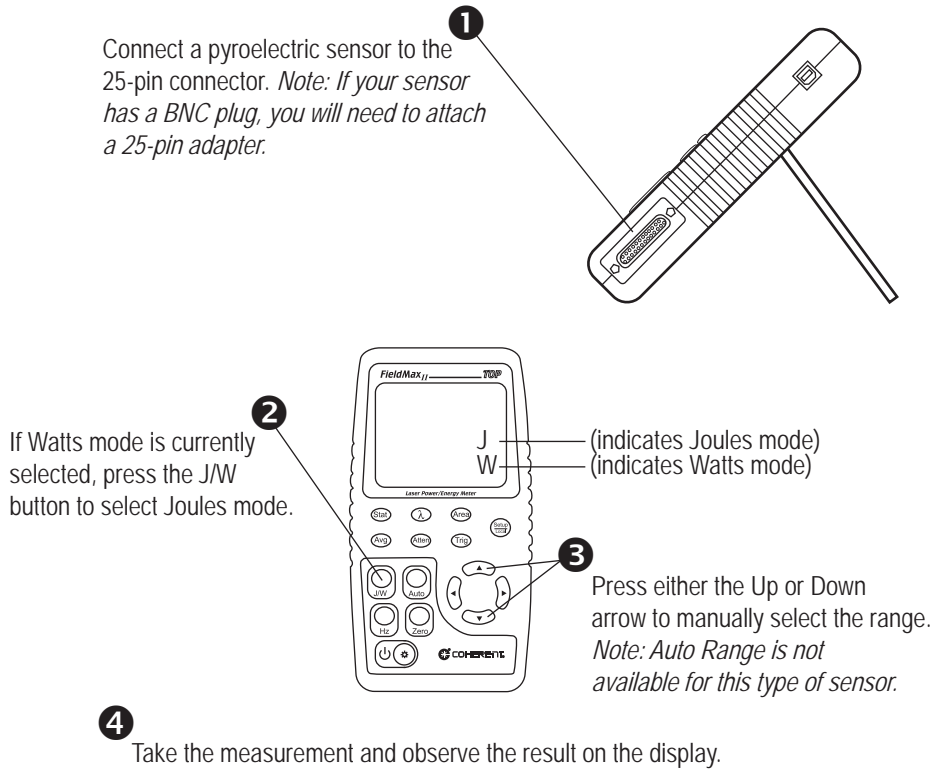

Figure 2-3. Measuring Energy With a Pyroelectric Sensor

Measuring Energy With a Thermopile Sensor

The following figure explains how to take an energy measurement using a thermopile sensor.

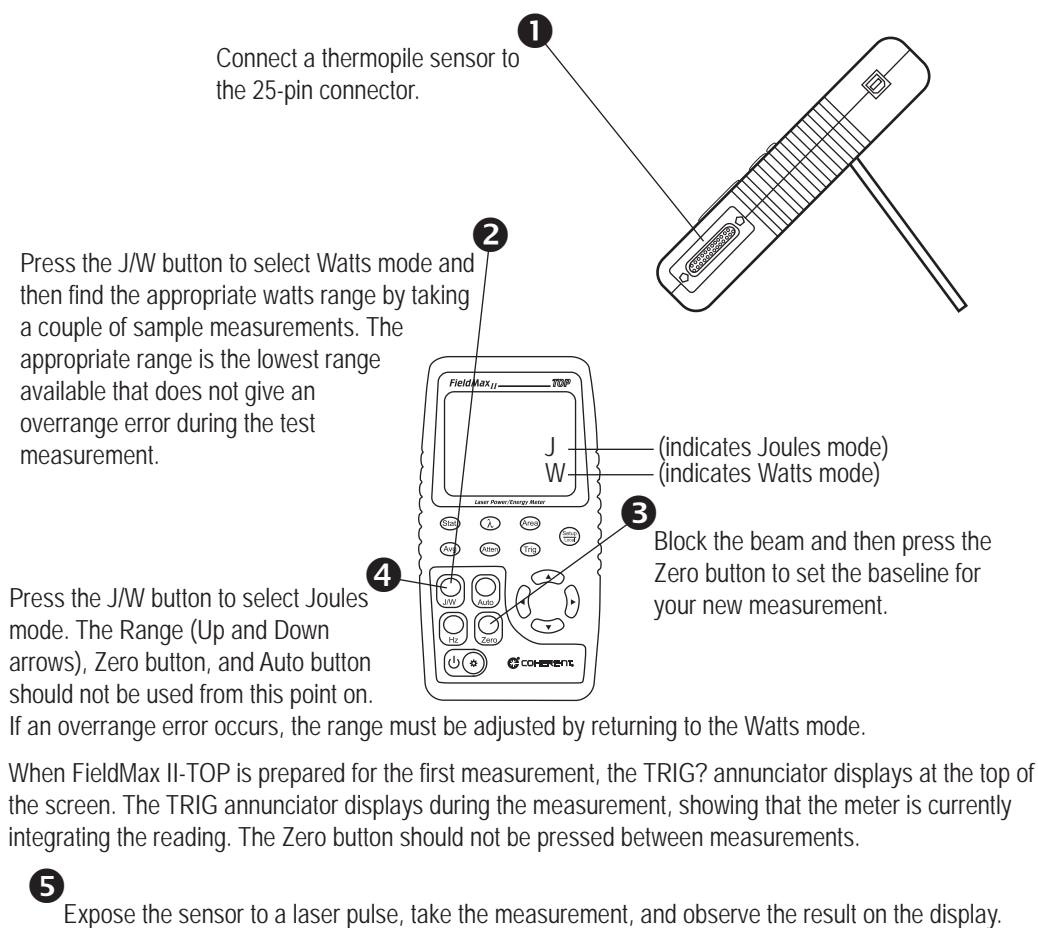

Figure 2-4. Measuring Energy With a Thermopile Sensor

SECTION THREE: DESCRIPTION

Thank you for purchasing the FieldMaxII-TOP™—a versatile, easy-to-use digital power/energy meter designed for field service and production applications.

In this section:

- Front panel (p. 3-2)
- Right side panel (p. 3-4)
- Left side panel (p. 3-5)

There are also instructions on how to replace the alkaline batteries (p. 3-5) and a brief overview of the AC adapter (p. 3-6).

Here is a list of specific features included in your FieldMaxII-TOP meter:

- 73 x 58 mm backlit LCD display
- Fast and effective laser tuning mode
- Works with thermopile, pyroelectric, and optical sensors
- Measures energy up to 300 pps
- Intuitive soft key-driven user interface
- USB 1.1
- Portable AC/DC operation
- Compact, rugged enclosure with stand

The versatile FieldMaxII-TOP measures:

- Power: W, W/cm^2
- Energy: J, J/cm^2
- Frequency: Hz
- Full statistics: max, min, mean, and standard deviation



Front Panel

The front panel—Figure 3-1, below—includes a liquid crystal display (LCD) and buttons that are used to enter parameters, select modes, and change ranges.

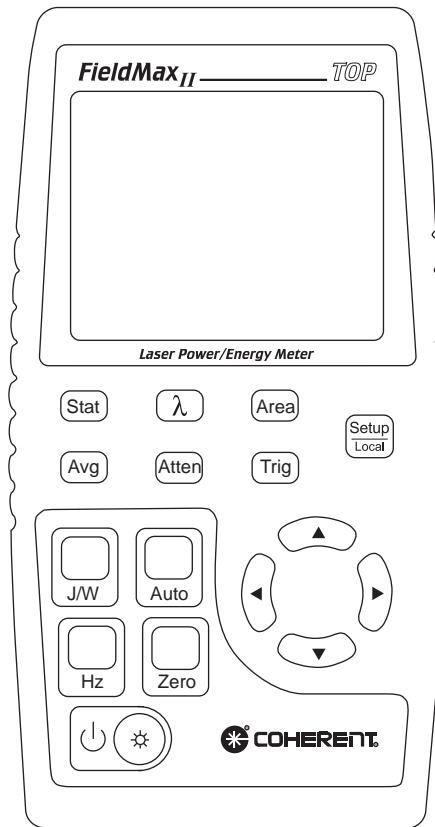



Figure 3-1. Front Panel

Buttons

The following buttons are on the front panel of the FieldMaxII-TOP:

- Setup/Local—starts or ends a parameter edit cycle. This button is also used to cancel the front panel lockout when Remote Control is active.
- Stat—statistics processing parameter
- Wave (λ)—wavelength compensation parameter
- Area—area correction parameter
- Avg—display smoothing parameter
- Atten—attenuation correction parameter
- Trig—trigger level parameter
- J/W—Joules or Watts mode
- Auto—Auto Ranging mode

- Hz—Rep Rate Display mode
- Zero—start batch. When Statistics mode is not active, this button can also be used to zero a sensor (thermopile or optical), or restart a batch (pyroelectric).
- —Power Switch/Backlight Toggle button
- Up Arrow (▲)—field adjust or range select
- Down Arrow (▼)—field adjust or range select
- Left Arrow (◀)—field select
- Right Arrow (▶)—field select

For detailed information about each of these buttons, refer to “Section Four: Operation” (p. 4-1).

Display

The LCD display provides visual measurement information. Figure 3-2, below, shows all the possible segments that may appear on the display.

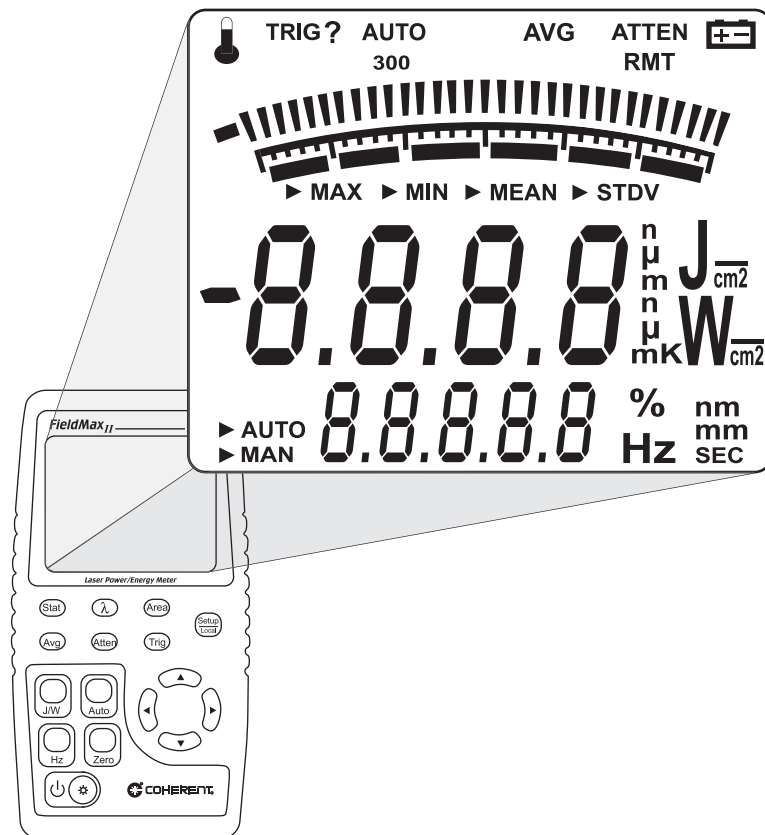

Figure 3-2. LCD Display

The type of sensor being used and the individually-selected settings determine what type of information will actually appear on the display

Information that appears on the display is divided into the groups described in the following list. Figure 3-2 (p. 3-3) shows the general location of each group).

- Annunciators: Temperature, TRIG,AUTO, Range Hint, AVG, ATTEN, RMT, and Battery
- Digital tuning feature
- Tuning meter scale
- Statistical parameters: MAX, MIN, MEAN, and STDV
- Numeric measurement value—large numeric characters
- Measurement units and engineering prefixes
- Statistical Sampling mode: AUTO and MAN
- Numeric data entry, batch count, parameter settings, and Hertz measurement values
- Data entry units, Hertz units, and current parameter units

For detailed information about these settings, refer to “Button Functions” (p. 4-11).

Right Side Panel

The right side panel contains the USB and Sensor connectors—refer to Figure 3-3.

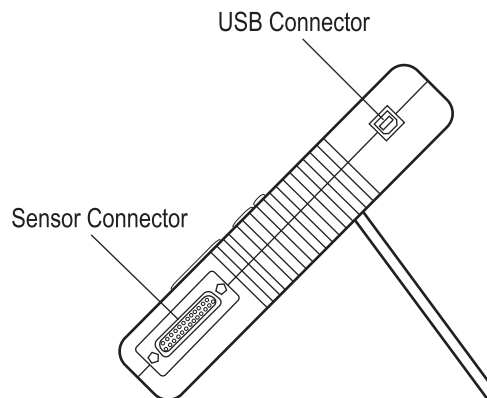

Figure 3-3. Right Side Panel

USB Connector

Attaching the cable—shipped with the meter—to this standard USB connector allows communication between FieldMaxII-TOP and a computer with a USB interface.

Sensor Connector

Use this connection to attach a DB-25 SmartProbe connector or adapter.

Left Side Panel

The left side panel contains the Analog Out and Power Jack connectors—refer to Figure 3-4.

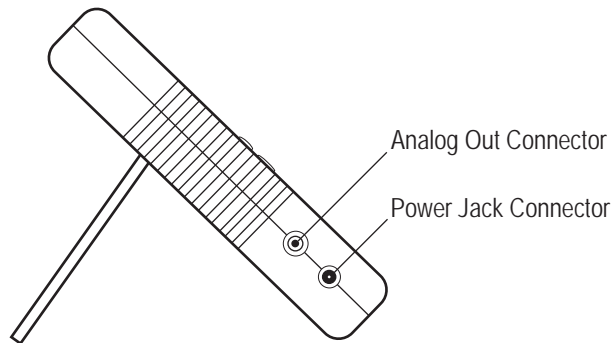

Figure 3-4. Left Side Panel

Analog Out Connector

When power is on, the Analog Out connector outputs a voltage proportional to the current laser measurement. The output voltage is zero (0) volts when the measured energy or power is zero (0) or less. The output voltage is the full-scale output voltage when the measured energy or power is full-scale or overranged. The full-scale output voltage (1V, 2V, or 5V) is selected via the host interface. Factory default full-scale output voltage is 2V.

Power Jack Connector

Connect the supplied power cord to this jack.

Battery Replacement

FieldMaxII-TOP uses a rechargeable battery pack (standard), six 1.5V alkaline batteries, or a 90-to-260 VAC, 50/60 Hz AC adapter—refer to “AC Adapter” (p. 3-6) for more information. Figure 3-5 illustrates how to replace the optional alkaline batteries.

Battery Directive

The batteries used in this product are in compliance with the EU Directive 2006/66/EC (“EU Battery Directive”).

Table 3-1. Batteries Contained in this Product

Description	Type
7.2V rechargeable battery pack	NiMH
(optional) 1.5V AA	Alkaline

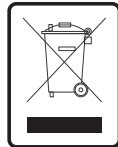

Dispose of batteries according to local regulations. Do not dispose as normal waste. Consult your local waste authorities for guidance.

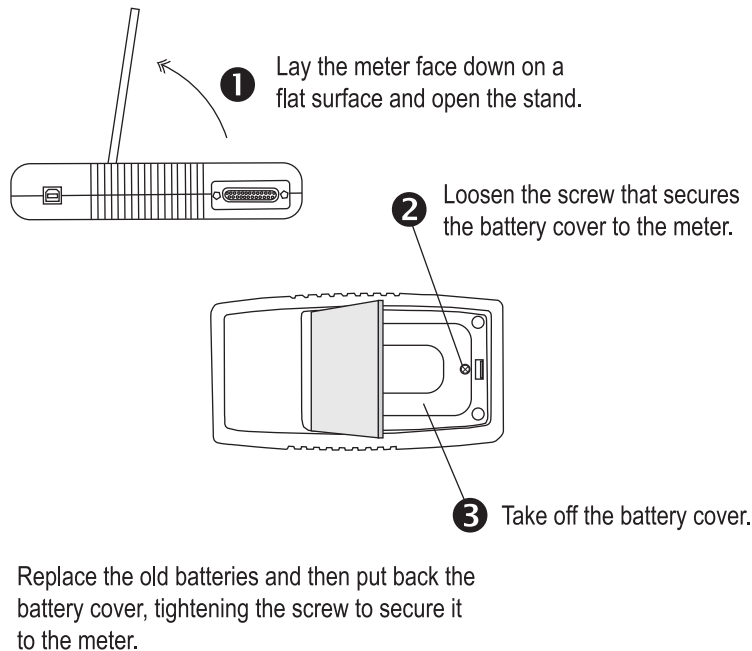

Figure 3-5. Optional Alkaline Battery Replacement

AC Adapter

Using an AC adapter prolongs battery life. FieldMaxII-TOP automatically senses when an adapter is used.

When batteries rather than an adapter, are used, the Battery annunciator flashes if the battery charge is low.

While in battery operation, if a sensor is not connected to the meter, power is automatically turned off after ten minutes.

SECTION FOUR: OPERATION

In this section:

- Tuning mode (this page)
- Annunciators (p. 4-3)
- Fault displays (p. 4-5)
- Invalid and not available data conditions (p. 4-5)
- Setup parameters (p. 4-6)
- Button functions (p. 4-11)
- Statistics mode (p. 4-12)
- Energy and power measurements (p. 4-13)
- Measurement display and range selection (p. 4-14)
- Pyroelectric-specific information (p. 4-16)
- Thermopile- and optical-specific information (p. 4-18)

Tuning Mode

This mode only works in Manual Ranging mode. For more information about ranging, refer to “Manual Ranging Mode” (p. 4-17) if you are using a pyroelectric sensor), or “Auto vs. Manual Ranging Mode” (p. 4-18) if you are using a thermopile or optical sensor).

As shown in Figure 4-1, below, tuning is visually displayed on the LCD using tuning needles and zone indicator bars.

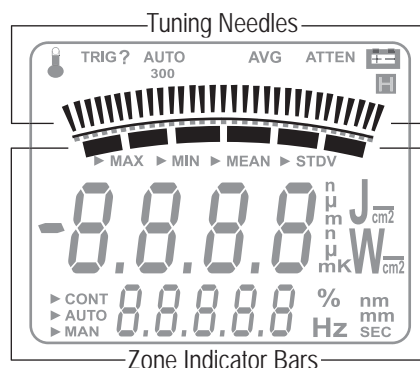

Figure 4-1. Location of Tuning Needles and Zone Indicator Bars

Tuning Needles

Tuning needles—which divide a given tuning zone into thirty “increments”—are used to peak a laser output. As the top or bottom of a zone is reached, the tuning needles automatically move to the center of the next zone (see Figure 4-2). Zone indicator bars let you know when this happens—refer to “Zone Indicator Bars,” below, for more information.

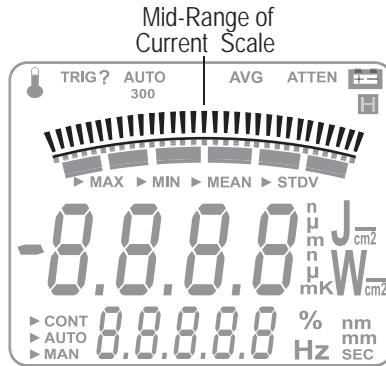

Figure 4-2. Current Scale Mid-Range

Zone Indicator Bars

Zone indicator bars are a series of six segments, as shown in Figure 4-3, below:

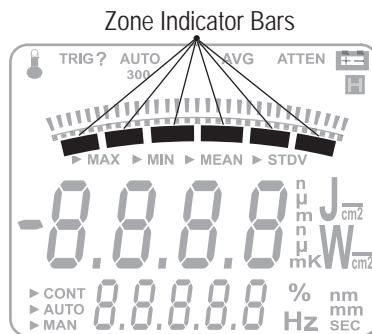

Figure 4-3. Zone Indicator Bars

These bars act as visual indicators while the tuning needles automatically move through zones, and also provide a relative indication of where the measurement falls within the active range.

Zone indicator bars always appear in pairs, with each overlapping zone representing 1/3 of full scale. Figure 4-4 shows how the five zone indicator bars correlate to full scale measurement on the tuning meter scale.

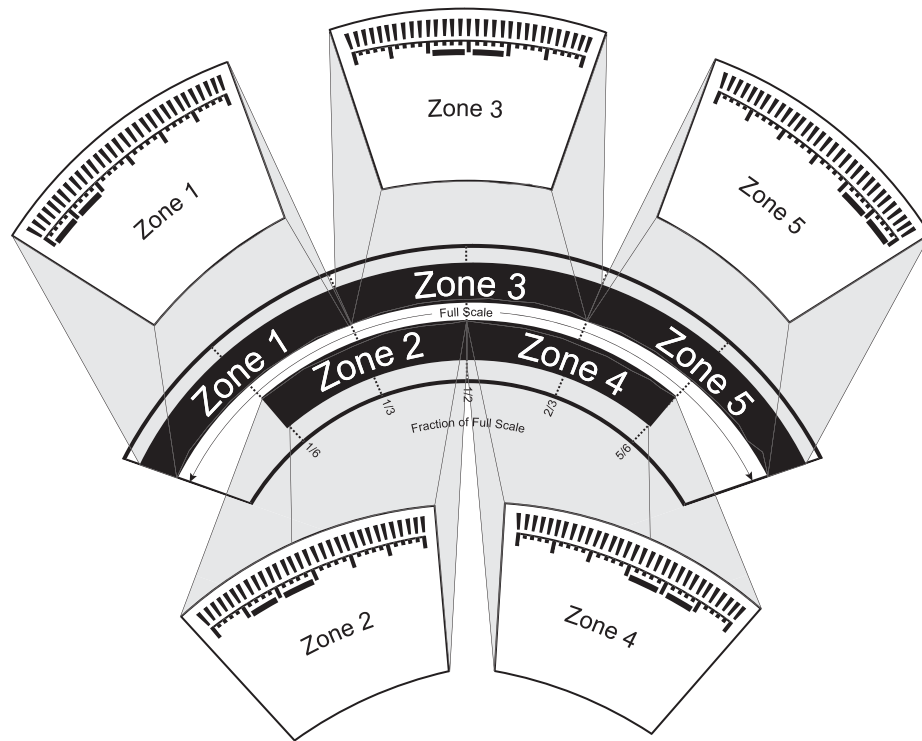

Figure 4-4. Comparison of Zone Indicator Bars to Full Scale Measurement

Figure 4-5 shows an example of how the zone indicator bars overlap on a 30-watt scale:

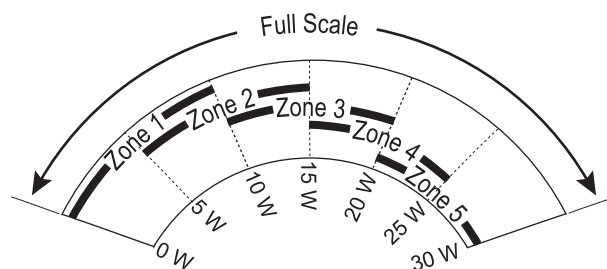

Figure 4-5. Tuning Mode Example - Full Scale

Annunciators

Annunciators refers to the icon-type symbols that appear on the LCD. Figure 3-2 (p. 3-3) shows all the annunciators on the Field-MaxII-TOP meter. The update rate for all annunciators is 3 times per second.

Temperature



(thermopile sensors only) The Temperature annunciator flashes whenever the meter detects a sensor over-temperature condition. This annunciator is not visible unless a sensor over-temperature condition exists.

TRIG

Whenever a trigger is detected, “TRIG” displays in the TRIG annunciator position. “TRIG?” displays in the absence of a trigger.

The TRIG annunciator applies under the following conditions:

- A pyroelectric sensor is attached.
- A thermopile sensor is attached and Joules mode is active.

AUTO

(thermopile and optical sensors only) The AUTO annunciator displays the state of the auto ranging of the meter. Auto Ranging is active when “AUTO” displays. If Auto Ranging is not active, or a pyroelectric sensor is attached to the meter, the AUTO annunciator is not visible.

Range Hint

The Range Hint annunciator—towards the top of the LCD, just above the tuning needles—displays “3,” “30,” or “300.” These numbers represent the full-scale range currently selected by the user. Range Hint is discussed in more detail under “Measurement Display and Range Selection” (p. 4-14).

AVG

When AVG (display smoothing) is active, display values are averaged (by samples) for pyroelectric sensors, and (by time) for thermopile and optical sensors. “AVG” displays when averaging is active. Nothing displays in this position if averaging is not active.

ATTEN

The ATTEN annunciator indicates if attenuation correction is applied to the measurement value. “ATTEN” displays whenever attenuation is active.

RMT

The RMT annunciator indicates that the FieldMaxII meter is currently in Remote Control mode. Remote Control is discussed under “Setup/Local” (p. 4-6).

Battery

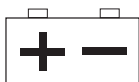

The Battery annunciator flashes whenever the batteries need to be replaced.

The Battery annunciator only appears when the meter is running on battery power, not the AC adapter.

Fault Displays

FieldMaxII-TOP is capable of detecting internal and user-induced faults. When a fault is detected, the letters “Er”, followed by a numeric fault code, appear on the display—refer to Table 4-1, below. You can dismiss a fault code by pressing any button, or by correcting the cause of the fault.

Table 4-1. Fault Codes

Error condition	Fault code
Unrecognized sensor	1
Sensor communication failure	2
Sensor error	3
Sensor error	4
Sensor/firmware version mismatch (sensor format version exceeds capability of the instrument firmware—firmware upgrade needed)	5
Sample rate fault	6
Hardware fault (detectable hardware error)	20
Bad zero ^a	40
Data overflow (result of an arithmetic operation that is greater than can be held in the allocated storage)	41
Wrong type of sensor is attached to the instrument	42

a. For more information about the bad zero fault code, refer to “Zero” (p. 4-11).

As an example, “Er 4” appears on the display if there is a sensor error. You can dismiss the fault by removing the sensor from the meter, or by pressing any button.

Attaching an unrecognized sensor to the meter creates a special fault condition. This condition is characterized by displaying a sensor fault (1 through 5).

Invalid and not Available Data Conditions

The update rate for invalid or not available data conditions is three times per second.

Invalid Data

Invalid data is obtained whenever the meter over-ranges. When invalid data is sensed, the letters “OL” (overload) appear on the display. If “OL” appears while in Auto mode, no further action needs to be taken. If “OL” appears while in Manual mode, start a new batch by pressing the Zero button. All data used to generate a batch result must be valid.

Not Available Data

Measurement data may be unavailable at certain times during meter operation. When data is not available, a series of dashes appears in the measurement area of the display. The following conditions will generate unavailable data:

- Meter is powered on and no pulse triggers are detected with a pyroelectric sensor.
- Function mode (Joules or Watts) is changed and no pulse triggers are detected with a pyroelectric sensor.
- Statistics mode is entered and batch data has not been compiled.

Setup Parameters

This section explains how to select and set user-definable parameters.

Setup/Local

The Setup/Local button serves several purposes:

1. If an edit cycle is not in progress, pressing the Setup/Local button initiates an edit cycle. If the next button pressed represents an edit parameter (STAT, WAVE, AREA, ATTEN, TRIG, or AVG button), Edit mode is entered and the parameter for the applicable button may be edited using the edit buttons. Additional presses of the Setup/Local button—without first pressing an edit parameter button—are ignored.
2. If a parameter has not been selected, pressing the Setup/Local button cancels an edit cycle.
3. If Edit mode is active and a parameter has been selected, pressing the Setup/Local button commits the adjusted edit parameter to the instrument.

4. Setup/Local is used to cancel the front panel lockout when Remote Control is active.

Remote Control is active when the instrument is connected to a host computer via a USB connection and is communicating with a host application program. While the instrument is in Remote Control mode, all front panel buttons—except Power/Backlight and Setup/Local—are disabled. Pressing the Setup/Local button while in Remote Control mode cancels Remote Control and returns the instrument to Local (all instrument functions available) mode.

The Setup/Local button is also used to edit user-defined parameters. Pressing this button initiates a parameter edit cycle.

A *parameter edit cycle* consists of:

- Pressing the Setup/Local button to begin the cycle.
- Pressing the parameter button (Stat, Wave (λ), Area, Avg, Atten, or Trig) that needs to be edited. If an edit cycle has been initiated, successive presses of the same edit parameter button will be ignored.
- Using the arrow buttons to select the appropriate field and adjust the data value.
- Pressing the Setup/Local button a second time to end the cycle and commit the new data value.

Stat

Pressing the Stat button will:

- Enter Statistics mode—if Statistics mode is not active and the button is pressed for less than two seconds.
- Exit Statistics mode.
- Enter Edit mode and select the statistics parameters to be edited (Batch Size and Restart mode) after edit cycle initiation (if Setup/Local is pressed beforehand). Batch size is 2 to 99,999 pulses (thermopile sensors in Joules mode, or pyroelectric sensors), or 1 to 99,999 seconds (thermopile sensors in Watts mode, or optical sensors).
- View the statistics parameters if the button is pressed for two seconds or more.

Wave

λ You can configure FieldMaxII-TOP to automatically account for any difference between the laser wavelength and the calibration wavelength. In the case of optical sensors, this compensation is necessary because the sensor contains calibration data from a number of different wavelengths. Thermopile and optical sensors include wavelength compensation information that is used in this mode.

After pressing Setup/Local, the Wave button is used to enter Edit mode and set the wavelength. If an edit cycle has not been initiated, pressing the Wave button will display the wavelength value. The available wavelength range is 1.00 to 99,999 nm. The actual range is sensor-dependent.

If Wavelength compensation information is not programmed into the sensor, you will not be able to change the wavelength data value.

Area

This mode allows the measurement of laser energy in terms of fluence, and laser power in terms of average power density.

Area calculation returns an *average* power density reading for both Flat and Gaussian profiles.

The parameter is entered as a diameter and assumes a circular beam or aperture. The range for Area mode is 0.01 to 999.99 mm.

Pressing the Area button will:

- Toggle the state of Area Correction mode, if the button is pressed for less than one second. Refer to “Area Correction and Zeroing” (p. 4-9) for more information about Area Correction mode.
- Enter Edit mode and select the beam diameter, if Setup/Local is pressed beforehand.
- View the beam diameter, if the button is pressed for one second or more.

Area Correction and Zeroing

(thermopile and optical sensors only)

It is important that you zero the sensor before using Area Correction, as explained in the following procedure.

1. Enter Area Correction by pressing the Area button for less than one second.
2. Set Auto Ranging by pressing the Auto button.
3. Block the sensor beam.
4. Allow the sensor to enter a steady (cool-down) state. If you are using a thermopile sensor, this steady state can be determined by watching the display numbers on the LCD. At first the numbers will decrease quickly but, as the sensor cools, the numbers decrease more slowly—the slower the decrease, the cooler the sensor, and the cooler the sensor, the more accurate the area correction reading will be. Optical sensors do not require a cool-down period.
5. Press the Zero button.

The sensor is now zeroed. For more information about zeroing, refer to “Zeroing” (p. 4-18).

Avg

Average mode enables display smoothing, which suppresses variations in the display reading that can make it difficult to read.

Display values are averaged either by time (for thermopile or optical sensors), or by pulses (for pyroelectric sensors).

You can change the size of the display smoothing window. With an attached thermopile or optical sensor, the window size is 1 to 60 seconds. Using a pyroelectric sensor, the window size is 2 to 1,000 pulses.

Averaging displays live measurements while the first batch is being acquired. Following the first batch, each reading appears on the display as an average of the batch (window) size. Example: Using a 10-second batch size, the first ten seconds are measured live. The next reading that appears on the display is an average of the measurements taken during the 1- to 10-second time frame, followed by a reading that is the average of the measurements taken during the 11- to 20-second time frame, etc.

The Avg button is used to:

- Toggle the state of Average mode (if the button is pressed for less than one second).
- Enter Edit mode and select the display smoothing window size (if Setup/Local is pressed beforehand).
- View the display smoothing window size (if the button is pressed for one second or more).

Atten

Attenuation mode allows you to get true measurements using an attenuator that has a known attenuation factor. When Attenuation Correction mode is enabled, the measured value is adjusted to indicate the measurement at the attenuator and not the sensor. The range for this mode is 0.01 to 999.99.

Here's an example of how to determine the attenuation correction factor that needs to be set in the FieldMaxII-TOP meter: If a 1 W laser beam is focused through an attenuator that has an attenuation factor of 50%, then, to get a true laser measurement value, the correction factor in the FieldMaxII-TOP instrument needs to be set to 2. In other words, since only half the power of the beam is transmitted through the attenuator, the measured result must be doubled to obtain a true laser measurement.

The Atten button is used to initiate several activities:

- Toggle the state of Attenuation Correction mode, if the button is pressed for less than one second.
- Enter Edit mode and select the attenuation factor, if Setup/Local is pressed beforehand.
- View the attenuation factor, if the button is pressed for one second or more.

Trig

After pressing the Setup/Local button, the Trig button is used to enter Edit mode and select the trigger level parameter that will be edited. If an edit cycle has not been initiated, pressing the Trig button will display the trigger level parameter. Trigger has a range of 2 to 20% of full scale. Refer to "Internal Triggering Mode" (p. 4-16) for details of the trigger function

Button Functions

J/W

The main function of this button is to toggle between Joules and Watts mode. *Only Watts mode can be active when an optical sensor is attached.*

Auto

(thermopile and optical sensors only) Pressing the Auto button instructs the FieldMaxII-TOP to select the best measurement range for the incoming signal.

Hz

(pyroelectric sensors only) Pressing the Hz button toggles the Pulse Frequency Display mode. If Hz mode is on, the pulse frequency displays in the parameter edit region of the display. If Hz mode is off, the pulse frequency does not display. If the pulse frequency is >300 Hz, the displays shows a series of three dashes, followed by the letters, "Hz."

Zero

(thermopile and optical sensors only) Pressing the Zero button causes the analog circuitry to zero its internal settings by running a zero cycle. If Auto Ranging is not active, the meter will zero the currently-selected range. If Auto Ranging is active, the meter will zero all available ranges for the attached sensor. When a zero procedure is in process, no other button events are queued or activated until the procedure ends. The zero procedure is immediately terminated if the sensor is disconnected or if an error is encountered.

Normally, the Zero button is pressed with the laser blocked from the connected sensor. If a finite power level is present at the sensor, the instrument will attempt to null it out. A *bad zero* fault code appears if a given power input is too large to null on the sensitive ranges.

If the bad zero fault code appears:

- Press any soft button to dismiss the error
- Select a new range
- Press the Zero button

The secondary function of the Zero button is to manually start a batch while in Statistics mode.

Power Switch and Backlight Toggle Button

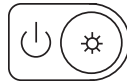

The combination Power Switch and Backlight Toggle button serves the dual purpose of turning power on/off to the meter, and toggling the backlight.

- When the meter is off, the power-on state is activated by pressing the button for one second.
- Pressing the button for one second while in the power-on state turns the meter off.
- When the meter is in the power-on state, the backlight state is toggled by pressing the button for less than one second.
- The backlight is always off when power is first applied to the meter.

Up and Down Arrows



These buttons serve a dual purpose. When Edit mode is active, the buttons are used to adjust the currently-selected edit field. When Edit mode is not active, the buttons are used to select the measurement range and automatically cancel Auto Range mode, if Auto Range mode is active.

Left and Right Arrows



This button pair has a dual purpose. When the Edit mode is active, the buttons allow you to select the edit field of the currently-selected edit parameter. When the Edit mode is not active and Statistics mode is active, the buttons are used to select the statistical parameter of interest (MAX, MIN, MEAN, or STDV). These buttons are nonfunctional when Edit mode and Statistics mode are not active.

Statistics Mode

FieldMaxII-TOP can be configured to display statistical data instead of instantaneous measurements. Statistical data for a pyroelectric sensor is generated on a pulse-by-pulse basis. Using a thermopile or optical sensor, statistical data is generated over time.

An exception to the above statement: When using a thermopile sensor with the instrument in Joules mode, energy is measured as integrated power from individual laser pulses.

Selecting Auto mode restarts the batch count used to take a reading. If the instrument is not in Auto mode, the batch count must be manually restarted by pressing the Zero button.

Pressing and holding the Stat button displays the current instrument mode: Auto or Manual.

For more information on selecting parameters while in Statistics mode, refer to “Left and Right Arrows” (p. 4-12).

Invalid Data

A statistical batch requires valid data for every data point in the batch. If a batch collection of data is in process and invalid data is measured, the batch is considered contaminated and the batch immediately ends with no batch result computed. If the Restart mode is Auto, a new batch is immediately restarted. The error that caused the contaminated batch is displayed.

Energy and Power Measurements

Energy (joules) measurements are taken using pyroelectric sensors (for pulsed laser) or thermopile sensors (for long-pulsed laser). The user interface behaves in a slightly different manner, depending on which type of sensor you are using. Energy measurements cannot be taken with an optical sensor.

When using a thermopile sensor in long pulse Joules mode, energy is measured as integrated power from individual laser pulses. For more information, refer to “Pulsed Thermopile Joules Mode” (p. 5-2).

Power (watts) measurements are taken using either pyroelectric sensors (for pulsed laser), or thermopile and optical sensors (for continuous laser).

A speedup algorithm is used while taking power measurements with a thermopile sensor. This algorithm is applied to the tuning needles to provide faster response while tuning a laser. Refer to “Tuning Mode” (p. 4-1). To improve accuracy, speedup is not applied to the numeric measurements.

As with energy measurements, there are slight variations in the user interface, depending on which type of sensor you are using.

Table 4-2, below, describes the measured information on the numeric display for various sensor types and mode settings.

Table 4-2. Numeric Display Information

Sensor Type	J Mode	W Mode
Thermopile	<ul style="list-style-type: none"> • Energy from a laser pulse by integrating power • Meter and Range Hint unavailable • Auto Range disabled 	CW and average power
	Statistics mode: MAX, MIN, MEAN	Statistics mode: MAX, MIN, MEAN
Optical	Function not available	CW power
		Statistics mode: MAX, MIN, MEAN
Pyroelectric	Energy per pulse	<ul style="list-style-type: none"> • Average power delivered by repeating pulses • Range Hint unavailable
	Statistics mode: MAX, MIN, MEAN,STDV ^a	Statistics mode: MEAN

a. In this mode, standard deviation is only available if the batch size is 200 or less.

Measurement Display and Range Selection

The display update rate for numeric measurement is three times per second.

Measurement range is selected in decade steps. Range selection—shown in Table 4-3 (p. 4-15), and Table 4-4 (p. 4-15)—is dependent on the sensor type and characteristics, as well as user-determined measurement settings.

FieldMaxII-TOP uses the “3’s” Rule—a display formatting rule in which the display value is not allowed to exceed 3, 30, or 300, depending on where the decimal point falls, with the decimal point located in a fixed position, as determined by the current range. Typically if a reading exceeds the “3’s” limit, the instrument is over-ranged or, in the case of Auto Ranging, the instrument will automatically range up.

Over-ranging refers to a meter setup condition in which the sensor output signal is greater than the maximum allowable level for the selected range. An “OL” (overload) appearing on the display signifies an over-range condition. Over-ranging generates invalid data. Table 4-3 indicates the display format for different full-scale range settings when in Joules mode.

Table 4-3. Full Scale Range Settings - Joules Mode

Full Scale Measurement	Display Format
3 nJ	X.YYY nJ
30 nJ	XX.YY nJ
300 nJ	XXX.Y nJ
3 μ J	X.YYY μ J
30 μ J	XX.YY μ J
300 μ J	XXX.Y μ J
3 mJ	X.YYY mJ
30 mJ	XX.YY mJ
300 mJ	XXX.Y mJ
3 J	X.YYY J
30 J	XX.YY J
300 J	XXX.Y J

When area correction is enabled in Joules or Watts mode, a “/cm²” will be appended to the units.

The Range Hint annunciator displays the full-scale range value with the engineering prefix and units omitted. For example, when the range is 30 J, the Range Hint annunciator displays “30.” Note that it also displays “30” when the selected range is 30 mJ, 30 μ J, or 30 nJ. For more information about the Range Hint annunciator, refer to “Range Hint” (p. 4-4).

Table 4-4 indicates the display format for different full-scale range settings when in Watts mode.

Table 4-4. Full Scale Range Settings - Watts Mode (Sheet 1 of 2)

Full Scale Measurement	Display Format
3 nW	X.YYY nW
30 nW	XX.YY nW
300 nW	XXX.Y nW
3 μ W	X.YYY μ W
30 μ W	XX.YY μ W
300 μ W	XXX.Y μ W
3 mW	X.YYY mW
30 mW	XX.YY mW
300 mW	XXX.Y mW

Table 4-4. Full Scale Range Settings - Watts Mode (Sheet 2 of 2)

Full Scale Measurement	Display Format
3 W	X.YYY W
30 W	XX.YY W
300 W	XXX.Y W
3 kW	X.YYY kW
300 kW	XX.YY kW

The Range Hint annunciator displays the full-scale range value with the engineering prefix and units omitted. For example, when the range is 30 kW, the Range Hint annunciator displays “30.” Note that it also displays “30” when the selected range is 30 W, 30 mW, 30 μ W, or 30 nW. For more information about the Range Hint annunciator, refer to “Range Hint” (p. 4-4).

Pyroelectric-Specific Information

Information in this section pertains exclusively to pyroelectric sensors. If you are using a thermopile or optical sensor, refer to “Thermopile- and Optical-Specific Information” (p. 4-18).

Internal Triggering Mode

For greatest accuracy and repeatability, FieldMaxII-TOP must trigger reliably for each laser pulse. *Internal triggering* refers to extracting an artificial trigger from the incoming signal.

To successfully extract an internally-generated trigger, set the meter range so that the incoming signal is at least 5% of the full scale. Set the trigger level at least 2% above the noise level and at least 2% below the peak height.

For example, with a peak height of 300 mJ, set the meter to a range of 3 J. A peak will occur at 10% of full scale, well above the 5% level. The trigger level should not be set higher than 8%. If the noise level is 5% of full scale (approximately 150 mJ), the trigger level should not be set lower than 7%.

In the example shown in Figure 4-6, below, the internal trigger threshold has been set to 8% (shown as a dashed line). Pulse A will definitely not generate a reliable trigger. Pulse B may generate a trigger, but not reliably. Pulses C and D will definitely generate reliable triggers.

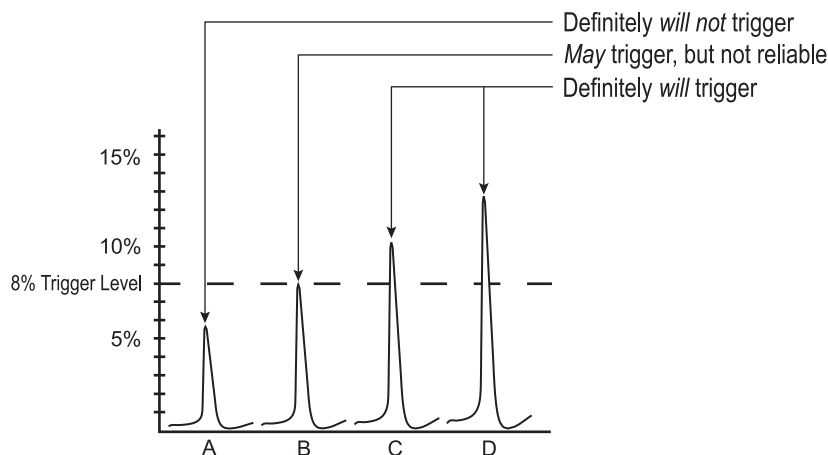

Figure 4-6. Internal Trigger Threshold

A full-scale signal on one range may not trigger on the next higher range unless the trigger level is set to less than 10%. For example, a near full-scale signal of 280 mJ on the 300 mJ range is less than 10% of full scale on the next higher range (3 J), and would therefore not trigger the reading. To obtain reliable triggering in this instance, adjust the trigger level to less than 8%.

The trigger is synchronous with the leading edge of the pulse, but the actual peak is determined algorithmically by sampling the input signal near the trigger. From the trigger point forward, the algorithm searches for peaks and from the trigger point back, it searches for a baseline.

Hz Display Mode

If desired, pulse frequencies may be displayed when a pyroelectric sensor is attached to the meter. For more information, refer to “Hz” (p. 4-11).

Manual Ranging Mode

(thermopile or optical sensors only) Manual ranging requires the user to select the range. Refer to “Up and Down Arrows” (p. 4-12) for more information about manual ranging.

Thermopile- and Optical- Specific Information

Information in this section pertains exclusively to thermopile and optical sensors. If you are using a pyroelectric sensor, refer to “Pyroelectric-Specific Information” (p. 4-16).

Auto vs. Manual Ranging Mode

Auto Ranging (Auto) enables FieldMaxII-TOP to automatically select the range (gain) when a thermopile or optical sensor is attached to the meter. While in Auto Ranging mode, the tuning needles represent a zero-to-full scale movement (as compared to Tuning mode, where the zones overlap). Refer to Figure 4-7, below.

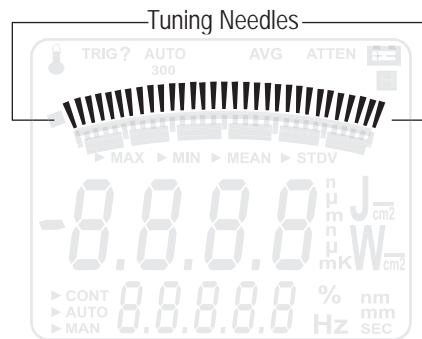

Figure 4-7. Auto Ranging

Manual ranging requires the range to be selected by the user. Refer to “Up and Down Arrows” (p. 4-12) for more information.

Zeroing

Thermopile and optical sensors require periodic zeroing. Zeroing occurs when a meter attempts to null out any signal coming from the sensor and establish a zero-power baseline. If Auto Ranging is active, the sensor is zeroed for every available range. If Auto Ranging is not active, the sensor is zeroed at the current range only. Under typical operating conditions, the zero procedure takes about one second for each range.

When starting the zeroing procedure, the large numerals on the LCD are replaced by an animated set of dashes. Unless there is an error, the normal measurement mode resumes once the zeroing procedure ends.

SECTION FIVE: SPECIAL TOPICS

In this section:

- Trigger states and the trigger annunciator (this page)
- Pulsed thermopile Joules mode (p. 5-2)
- Pyroelectric Watts mode (p. 5-2)
- Negative power display (p. 5-3)
- Digital tuning feature use in Statistics mode (p. 5-4)
- USB driver installation (p. 5-4)

Trigger States and the Trigger Annunciator

Two segments are dedicated to the indication of the trigger state of the meter. These are the TRIG and the ? segment that follows it. The trigger state is always used when a pyroelectric sensor is attached.

There are two possible trigger states when a pyroelectric sensor is attached: “triggered” and “wait for trigger.” The triggered state indicates that the meter is capturing laser pulses. The wait for trigger state indicates an absence of pulse triggers. When a pulse is captured, the trigger state becomes active and the wait for trigger state becomes inactive. If no pulses are captured within 1.67 seconds since the last pulse was captured, the wait for trigger state becomes active and the triggered state becomes inactive. The TRIG annunciator reads “TRIG” in the triggered state and “TRIG?” in the wait for trigger state.

There are two possible states when a thermopile sensor is attached and Joules mode is active: “integrating” and “wait for trigger.” The integrating state indicates that laser power is being integrated to produce a final energy measurement. The wait for trigger state indicates the meter is waiting for a power pulse to integrate. When the meter detects a power pulse trigger, the integrating state becomes active and the wait for trigger state becomes inactive. The integrating state persists until the power signal decays to the point where the tail energy can be predicted. At that point the wait for trigger state becomes active and the integrating state becomes inactive. The TRIG annunciator reads “TRIG” in the integrating state and “TRIG?” in the wait for trigger state.

Pulsed Thermopile Joules Mode

(for long-pulsed lasers only) When a thermopile sensor is attached, the meter has the capability of measuring energy from a finite duration laser pulse, or from a series of finite duration laser pulses. (Thermopile sensors are typically used to measure laser power and have an extremely slow response time relative to the pulse width of the laser used to generate the power signal.)

The power curve—refer to Figure 5-1, below—is integrated from the pulse start to infinity. The final energy value is algorithmically calculated shortly after peak power is attained.

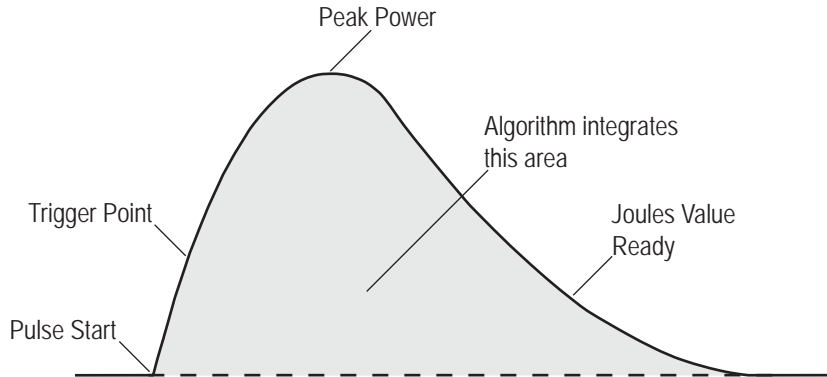

Figure 5-1. Measuring Energy - Pulsed Thermopile Joules Mode

There is no energy range in long-pulse Joules mode. The level of precision is based upon the range set in Power mode prior to entering Joules mode.

Pyroelectric Watts Mode

Using an attached pyroelectric sensor, FieldMaxII-TOP can measure power from a series of pulses. While the instrument is triggering, power measured during each display interval appears in the numeric display as watts. This is known as *burst power* (see the following paragraph). At least two pulses must be captured in one display cycle (approximately 1/3 second) to calculate power. If the instrument is not triggering, a series of dashes—indicating “no power”—appears in the numeric display.

Burst power (see Figure 5-2, below) refers to power in watts, as computed by the sum of the energy pulses received in one display cycle (approximately 1/3 second), and the sum of the time intervals between those pulses. The displayed value represents the power of a continuous stream of pulses that the burst represents.

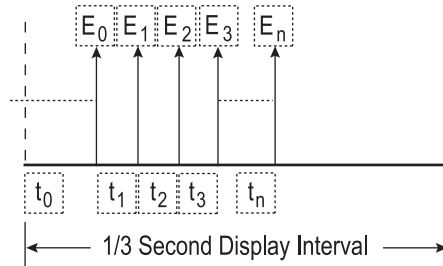

Figure 5-2. Burst Power

The first pulse is used to trigger the calculation and is discarded because its time interval, t_0 , is indeterminate.

When $n = 0$, power is zero. This situation occurs when only one pulse is received in a display period (for example, interval B in Figure 5-3, below). To offset this limitation, a laser pulse rate of at least 6 Hz is required for burst power measurements.

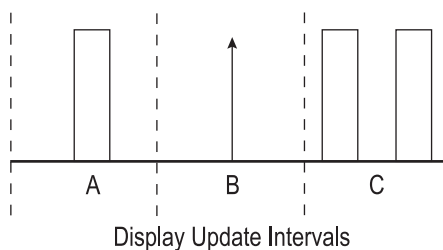

Figure 5-3. Burst Power Limitations

Another limitation occurs on multiple bursts (interval C in Figure 5-3, above). If there are two or more bursts in any display interval, the gap between bursts will appear as lower power and the display will be affected accordingly.

Negative Power Display

A negative power reading indicates the sensor needs to be zeroed. Two areas of the display are affected by a negative power reading: the digital tuning feature and the numeric measurement display.

The digital tuning feature always displays the absolute value of measured power. If the power is negative, the minus sign segment is turned on. The inertia of a mechanical meter will be mimicked for negative, as well as positive, power readings.

Digital Tuning Feature Use in Statistics Mode

The tuning needles and zone indicator bars are not present in Statistics mode.

USB Driver Installation

When first connecting the meter to a PC with the USB cable, you will be prompted through an installation process. USB drivers will be automatically installed onto your computer. Insert the CD into your CD drive when prompted.

SECTION SIX: HOST INTERFACE

Overview

The host interface is intended for use with a National Instruments LabVIEW virtual instrument (VI) that accesses an ActiveX DLL called FieldMax2Lib.dll. The DLL handles communication and data transmission between the FieldMaxII and host applications written in LabVIEW. A Getting Started introduction and LabVIEW examples are provided on the CD that ships with the meter.

SECTION SEVEN: CALIBRATION AND WARRANTY

In this section:

- Calibration (this page)
- Coherent calibration facilities and capabilities (this page)
- Limited warranty (p. 7-2)
- Extended warranty (p. 7-2)
- Warranty limitations (p. 7-3)
- Obtaining service (p. 7-3)
- Product shipping instructions (p. 7-4)

Calibration

Coherent laser power and energy meters are precision instruments, capable of delivering very accurate measurements, as well as providing many years of useful service. To maintain this high level of performance, it is important to have your measurement system serviced and recalibrated once a year.

Coherent Calibration Facilities and Capabilities

As the largest laser manufacturer in the world, Coherent has been able to build state-of-the-art calibration facilities containing the widest possible range of laser types and technologies. This enables us to perform instrument and sensor calibration under virtually any combination of wavelength, power, and operating characteristics. Sensors are calibrated against NIST-traceable working standard sensors which are, in turn, calibrated against NIST-calibrated golden standard sensors. These working and golden standards are maintained with the utmost care, recalibrated annually, and verified even more regularly. We maintain multiple NIST-calibrated standards at many laser wavelengths to support the growing calibration needs of our customers. Optical calibration is a core competency at Coherent and we strive to continually improve our methods, precision, and repeatability. Additionally, most of the calibrations are performed with highly automated systems, thus reducing the possibility of human error to nearly zero. Strict quality inspections during many stages of calibration and testing assure a precise and accurate instrument that is NIST traceable and CE marked. The benefit to our customers is that instruments calibrated by Coherent will consis-

tently perform as expected under their actual use conditions. We are a registered ISO 9001:2000 company, our products are NIST traceable, and our calibration labs are fully ANSI Z540 compliant.

In addition to the technological advantage, we also strive to deliver the best service in the industry, with a knowledgeable and responsive staff, and rapid turnaround.

Limited Warranty

Coherent, Inc. (the “Company”) warrants its laser power and energy meters and sensors products (“Products”) to the original purchaser (the “Customer”) that the product is free from defects in materials and workmanship and complies with all specifications, active at the time of purchase, for a period of twelve (12) months.

Coherent, Inc. will, at its option, repair or replace any product or component found to be defective during the warranty period. This warranty applies only to the original purchaser and is not transferable.

Extended Warranty

Coherent, Inc. (the “Company”) offers original purchasers (the “Customer”) purchasing laser power and energy meters and sensors products (“Products”) an extended twelve (12) month warranty program, which includes all parts and labor. In order to qualify for this warranty, a Customer must return the Product to the Company for recalibration and recertification. The Company will recertify the Product, provide software upgrades, and perform any needed repairs, and recalibrate the Product, for a fixed service fee (as established by the Company from time to time and in effect at the time of service). If the product cannot be recertified due to damage beyond repair, parts obsolescence, or other reasons, the Customer may be informed that an Extended Warranty program is not available for the Product.

If the Product fails and is returned to the Company within one year following the date of recalibration and recertification service, the Company will, at its option, repair or replace the Product or any component found to be defective. If the Product must be replaced and the Product is no longer available for sale, Coherent reserves the right to replace with an equivalent or better Product. This warranty applies only to the original purchaser and is not transferable.

Warranty Limitations

The foregoing warranties shall not apply, and Coherent reserves the right to refuse warranty service, should malfunction or failure result from:

- Damage caused by improper installation, handling or use.
- Laser damage (including sensor elements damaged beyond repair).
- Failure to follow recommended maintenance procedures.
- Unauthorized product modification or repair.
- Operation outside the environmental specifications of the product.

Coherent assumes no liability for Customer-supplied material returned with Products for warranty service or recalibration.

THIS WARRANTY IS EXCLUSIVE IN LIEU OF ALL OTHER WARRANTIES WHETHER WRITTEN, ORAL, OR IMPLIED. COHERENT SPECIFICALLY DISCLAIMS THE IMPLIED WARRANTIES OF MERCHANTABILITY AND FITNESS FOR A PARTICULAR PURPOSE. IN NO EVENT SHALL THE COMPANY BE LIABLE FOR ANY INDIRECT, INCIDENTAL OR CONSEQUENTIAL DAMAGES IN CONNECTION WITH ITS PRODUCTS.

Obtaining Service

In order to obtain service under this warranty, Customer must notify the Company of the defect before the expiration of the warranty period and make suitable arrangements for the performance of service. The Company shall, in its sole discretion, determine whether to perform warranty service at the Customer's facility, at the Company's facility or at an authorized repair station.

If Customer is directed by the Company to ship the product to the Company or a repair station, Customer shall package the product (to protect from damage during shipping) and ship it to the address specified by the Company, shipping prepaid. The customer shall pay the cost of shipping the Product back to the Customer in conjunction with recalibration and recertification; the Company shall pay the cost of shipping the Product back to the Customer in conjunction with product failures within the first twelve months of time of sale or during an extended twelve month warranty period.

A Returned Material Authorization number (RMA) assigned by the Company must be included on the outside of all shipping packages and containers. Items returned without an RMA number are subject to return to the sender.

Table 7-1. Coherent Service Centers

Location	Phone	Fax	E-mail
USA	1.800.343.4912	503.454.5777	info_service@coherent.com
Europe	+49-6071-968-0	+49-6071-968-499	info_service@coherent.com
International	503.454.5700	503.454.5777	info_service@coherent.com

Product Shipping Instructions

To prepare the product for shipping to Coherent:

1. Contact Coherent Customer Service for a Return Material Authorization number—refer to Table 7-1 (p. 7-4).
2. Attach a tag to the product that includes the name and address of the owner, the person to contact, the serial number, and the RMA number you received from Coherent Customer Service.
3. Wrap the product with polyethylene sheeting or equivalent material.
4. If the original packing material and carton are not available, obtain a corrugated cardboard shipping carton with inside dimensions that are at least 6 in (15 cm) taller, wider, and deeper than the product. The shipping carton must be constructed of cardboard with a minimum of 375 lb (170 kg) test strength. Cushion the instrument in the shipping carton with packing material or urethane foam on all sides between the carton and the product. Allow 3 in (7.5 cm) on all sides, top, and bottom.
5. Seal the shipping carton with shipping tape or an industrial stapler.
6. Ship the product to:

Coherent, Inc.
27650 SW 95th Ave.
Wilsonville, OR 97070
Attn: RMA # (*add the RMA number you received from
Coherent Customer Service*)

APPENDIX A: SPECIFICATIONS

Table A-1, below, lists specifications for the FieldMaxII-TOP.

Table A-1. Specifications (Sheet 1 of 2)

Parameter	Description
Electrical/Mechanical	
Analog Output	1, 2, or 5V full-scale (user-adjustable) 100 ohm source impedance
Battery Operating Time* (approx)	<i>Rechargeable</i> <i>Alkaline</i>
Thermopile	16 hr. 48 hr.
Pyroelectric	8 hr. 24 hr.
* Without a backlight	
Calibration Accuracy	± 1%
Digital Output	USB 1.1
Digital Tuning Needle	100 mS (tau) 20 Hz (update rate)
Power Requirements	<i>AC operation:</i> 90-to-260 VAC, 50/60 Hz <i>DC power input:</i> 12 VDC, 1.25A, center-positive <i>Battery operation:</i> rechargeable battery pack (standard) or six optional 1.5V AA alkaline batteries (battery specifications are listed earlier in this table under “Battery Operating Time”)
Pyroelectric Input (maximum voltage input)	18V
Internal Trigger	2 to 20% full scale (selectable)
Linearity	± 1%
Measurement Resolution	± 0.1% of full scale
Environmental	
Altitude	4,500 m (operating) < 12,000 m (storage)
Relative Humidity	< 90% (5 to 40° C) (operating) < 95% (0 to 70° C) (storage)
Temperature	5 to 40° C (operating) -20 to 70° C (storage)
Ranges	
Area Parameter (entered as a diameter)	0.01 to 999.99 mm
Attenuation (Attenuation parameter)	0.01 to 999.99

Table A-1. Specifications (Sheet 2 of 2)

Parameter	Description
Batch Size (Statistics parameter) Thermopile sensor in watts mode, or optical sensor Thermopile sensor in joules mode, or pyroelectric sensor	1 to 99,999 seconds 2 to 99,999 pulses
Measurement Range (full scale, sensor-dependent) Energy Mode Power Mode	3 nJ to 300 kJ (thermopile sensors, long pulse) 3 nJ to 300 kJ (pyroelectric sensors) 3 nW to 300 kW (thermopile sensors) 3 nW to 300 kW (optical sensors) 3 nW to 300 kW (pyroelectric sensors)
Rep Rate	± 1 Hz (accuracy) 300 Hz (maximum) 1 Hz (resolution)
Window Size (Avg parameter) Thermopile or Optical sensor Pyroelectric sensor	1 to 60 seconds 2 to 99,999 pulses
Physical Characteristics	
Dimensions (h x w x d) (approx)	8 in. (20 cm) 4 in. (10 cm) 1.5 in. (4 cm)
Display	58 x 73 mm fixed-segment LCD with backlight
Weight (approx, including batteries)	1.1 lb. (0.5 kg)
Miscellaneous	
Regulations Met	CE

INDEX

A

- AC adapter 3-6
- Annunciator display functions 4-3
- Area button function 4-8
- Area correction and zeroing 4-9
- ATTEN annunciator 4-4
- Atten button function 4-10
- AUTO annunciator 4-4
- Auto button function 4-11
- AVG annunciator 4-4
- Avg button function 4-9

B

- Bad zero 4-11
- BATTERY annunciator 4-5
- Battery replacement 3-5
- Button functions
 - Area 4-8
 - Atten 4-10
 - Auto 4-11
 - Avg 4-9
 - Hz 4-11
 - J/W 4-11
 - Left and right arrows 4-12
 - Power switch and backlight toggle button 4-12
 - Setup/Local 4-6
 - Stat 4-7
 - Trig 4-10
 - Up and down arrows 4-12
 - Wave (lambda) 4-8
 - Zero 4-11

C

- Calibration 7-1
- Coherent calibration facilities and capabilities 7-1
- Connector
 - Power jack 3-5
 - Sensor 3-5
 - USB 3-5

D

- Digital tuning feature in statistics mode 5-4
- Display functions
 - Annunciators 4-3
 - Fault displays 4-5
 - Invalid and not available data conditions 4-5
 - Measurement display and range selection 4-14

E

- Energy and power measurements 4-13

- Extended warranty 7-2

F

- Fault displays 4-5
- Front panel overview 3-2

H

- Hz
 - Button function 4-11
 - Display mode 4-17

I

- Internal triggering mode 4-16
- Invalid and not available data conditions 4-5
- Invalid data 4-13

J

- J/W button function 4-11

L

- LCD display 3-3
- Left and right arrows 4-12
- Left side panel overview 3-5
- Limited warranty 7-2

M

- Measurement display and range selection display 4-14
- Meter modes
 - Hz display 4-17
 - Internal triggering 4-16

N

- Negative power display 5-3
- Not available data 4-6

O

- Overview
 - AC adapter 3-6
 - Battery replacement 3-5
 - Front panel 3-2
 - Left side panel 3-5
 - Right side panel 3-4

P

- Power
 - Jack connector 3-5
 - Switch and backlight toggle button 4-12
- Product shipping instructions 7-4
- Pulsed thermopile Joules mode 5-2
- Pyroelectric-specific information
 - Hz display mode 4-17
 - Internal triggering mode 4-16

Q

Quick Start

- Measuring average power with a pyroelectric sensor 2-2
- Measuring energy with a pyroelectric sensor 2-4
- Measuring energy with a thermopile sensor 2-5
- Measuring power with a thermopile or optical sensor 2-3

R

- Range hint annunciator 4-4
- Right side panel overview 3-4

S

- Sensor connector 3-5
- Service 7-3
- Setup parameters
 - Area 4-8
 - Atten 4-10
 - Avg 4-9
 - Setup/Local 4-6
 - Stat 4-7
 - TRIG 4-10
 - Wave 4-8
- Setup/Local button function 4-6
- Speedup 4-13
- Stat button function 4-7
- Statistics mode 4-12
 - and digital tuning feature 5-4

- and invalid data 4-13

T

- Temperature annunciator 4-4
- TRIG annunciator 4-4
- Trig button function 4-10
- TRIG? annunciator 4-4
- Trigger states and the trigger annunciator 5-1
- Tuning
 - Mode 4-1
 - Needles 4-2

U

- Up and down arrows 4-12
- USB connector 3-5

W

- Warranty
 - Extended 7-2
 - Limitations 7-3
 - Limited 7-2
- Wave (lambda) button function 4-8

Z

- Zero
 - Bad 4-11
 - Button function 4-11
- Zone indicator bars 4-2

