

# IQTX



## COHERENT MODULATION TRANSMITTER

SPECIFICATION SHEET

## The ideal ‘golden’ optical signal source

Generating and controlling phase modulated optical signals is easy with the IQTX. The IQTX is referred to as a ‘Golden’ reference optical signal source because of its high repeatability and reliability. Its high bandwidth of 40 GHz ensures high quality optical signal generation, making it the ideal optical signal source for coherent communications applications.

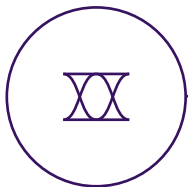

### High-quality signal generation

With bandwidth of up to 40 GHz, generate baud rates up to 80 GBaud. 40 GHz bandwidth is perfect for 600 Gbps signals based on 56 GBaud 64QAM modulation format.

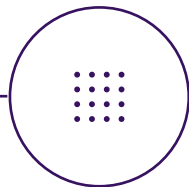

### Generate 16QAM & more

The IQTX uses high bandwidth linear RF amplifiers to enable generation of any multi-level optical modulation formats when used with RF Arbitrary Waveform Generators (AWG).

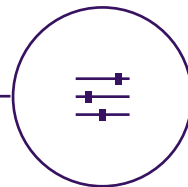

### High performance ABC

Modulation format and data independent Automatic Bias Controller tracks and compensates for any bias drifts so you can set and forget.

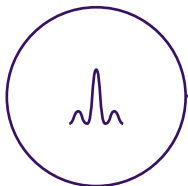

### Narrow linewidth laser

The built-in tunable laser with a narrow 100 KHz linewidth and 15 dBm of output power is an ideal laser source for coherent modulation formats. You can also use your own laser if preferred.

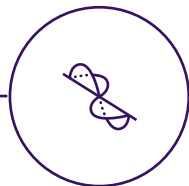

### Dual polarization emulator

Single polarization model come with an emulated dual polarization generator which optically multiplexes a time delayed copy of the single polarization signal.



### User-friendly GUI

COHESIONUI™ provides simple set up and full software control. Automatically discover compatible instruments on the Local Area Network and control the IQTX from the comfort of your own desk.

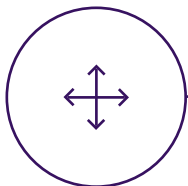

### Versatile configuration

Supports full dual polarization, emulated dual polarization or single polarization

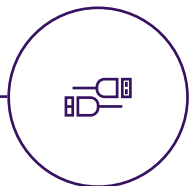

### USB & Ethernet operation

Connect with USB and/or Ethernet for simple setup and operation.

## FEATURES

- Choose from 11 GHz, 20 GHz, 23 GHz or 40 GHz of bandwidth
- Pattern independent Automatic Bias Control
- High repeatability and reliability of optimized optical signals
- Inbuilt narrow linewidth tunable laser
- Perfect for M-QAM, M-PSK and custom modulation formats
- Intuitive and user-friendly GUI
- Complete remote control capability
- Capable of supporting Baud rates beyond 64 GBaud

## PATTERN-INDEPENDENT AUTOMATIC BIAS CONTROLLER

The built-in Automatic Bias Control (ABC) makes it easy for engineers to quickly generate optimized signals. The ABC's high stability ensures that bias points are maintained at the desired location and allows engineers to work with Arbitrary modulation formats including M-QAM, M-PSK, etc.

Our dedicated software for ABC offers complete remote operation capability allowing the user to control the setup. These features make the Quantifi Photonics' IQTX a superb plug-and-play R&D optical signal generator.

## EXAMPLE APPLICATIONS

Optical communication R&D engineers need to be able to quickly and cost-effectively generate high-bandwidth optical signals such as 56 GBaud DP-QPSK to support development in fields such as:

- Coherent receiver design verification and testing
- 400G, 600G coherent system development using multi-leveled modulation formats such as 16QAM and 64QAM
- Stable and repeatable DP-QPSK or DP-16QAM signal generation for ICR Testing
- Cost effective DWDM channel loading by modulating multiple carriers



## 56 GBaud 64 QAM

Generated using 92 GSa/s AWG and 40 GHz Dual Polarization IQTX. 6.2% EVM.

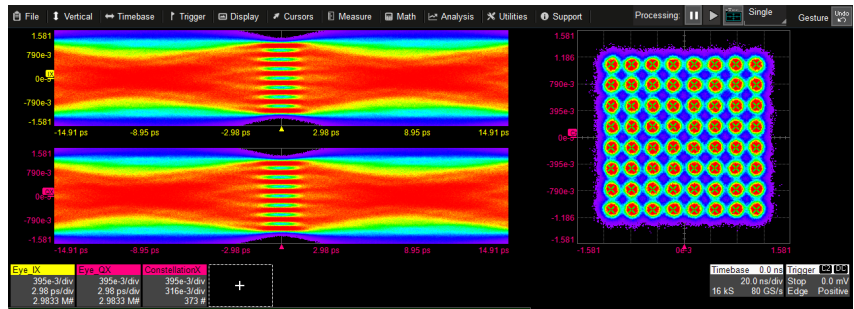

## 56 GBaud 16 QAM

Generated using a 3-bit PowerDAC and 40 GHz Dual Polarization IQTX. 9.5% EVM.

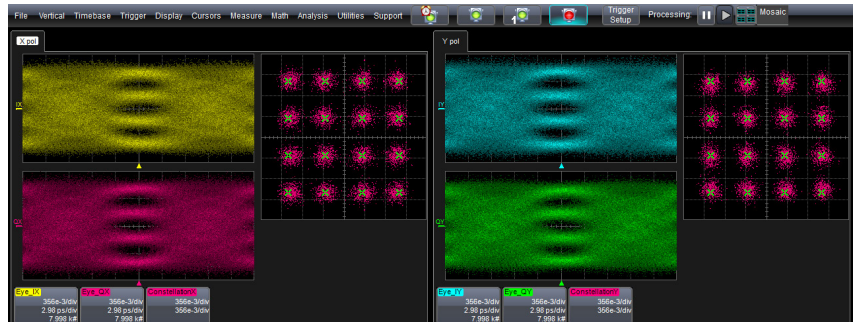

## 32 GBaud 16QAM

Generated using a 65 GSa/s AWG and 26 GHz Single Polarization IQTX with Dual Polarization Emulator. 6.7% EVM.

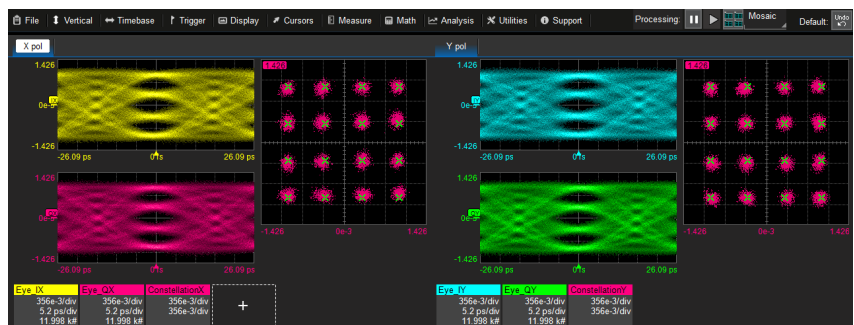

## 32 GBaud QPSK

32 GBaud QPSK generated using a 65 GSa/s AWG and 26 GHz Single Polarization IQTX with Dual Polarization Emulator. 6.8% EVM

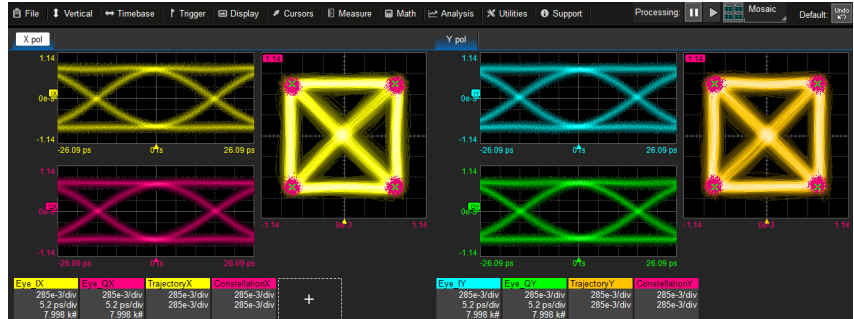

## 21 GBaud DP-8 QAM

High quality DP-8 QAM signal at 21 GBaud. EVM ~ 6.53%

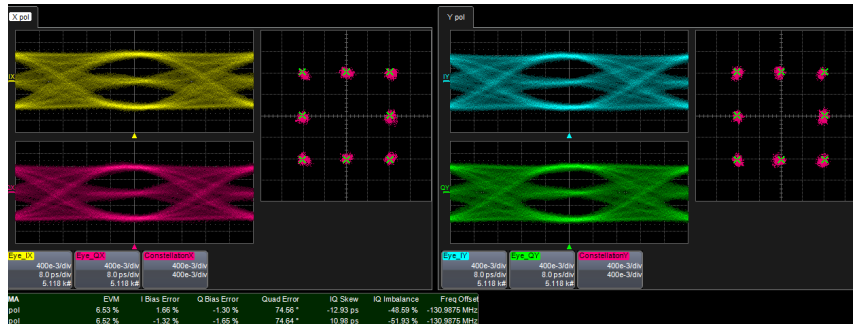

## 21 GBaud BPSK

High quality BPSK signal at 21 GBaud. EVM ~ 7.31%

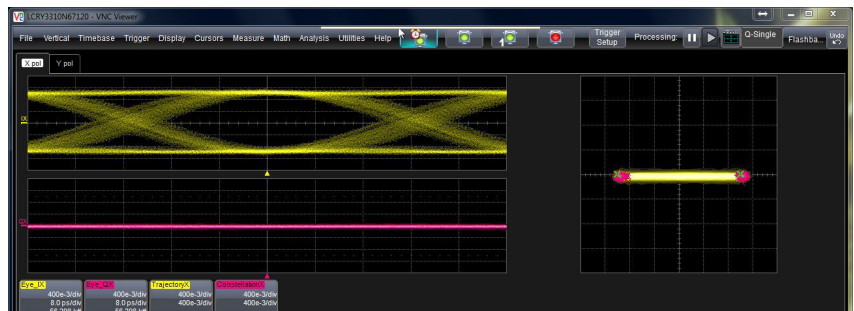

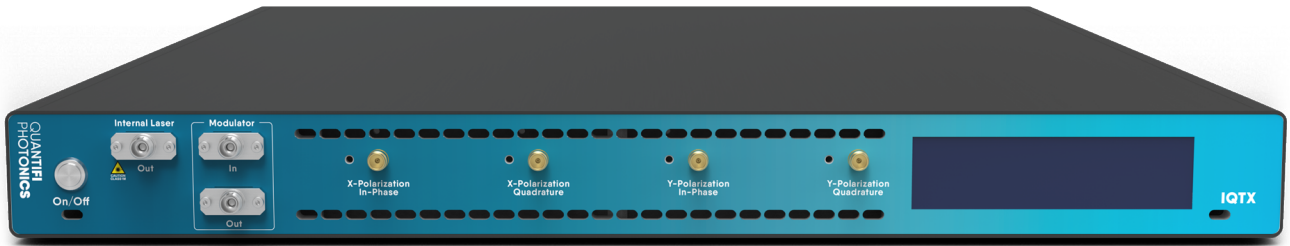

IQTX-1203

### Instrument dimensions

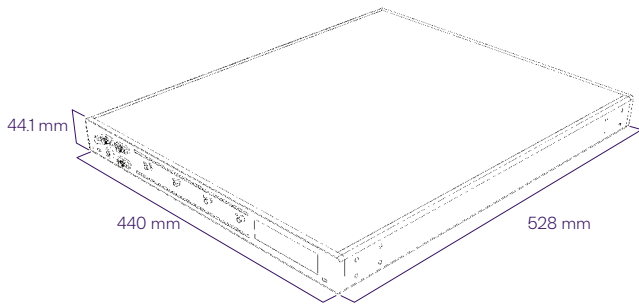

### Rear panel connections

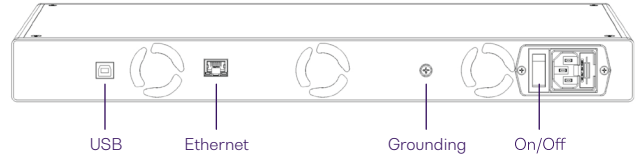

# Intuitive user interface for more flexibility in modulator bias control

IQSignal-Manager is the dedicated bias control software to adjust individual bias settings or select automatic optimization, which lets you quickly and effortlessly generate optimized QPSK or QAM signals.

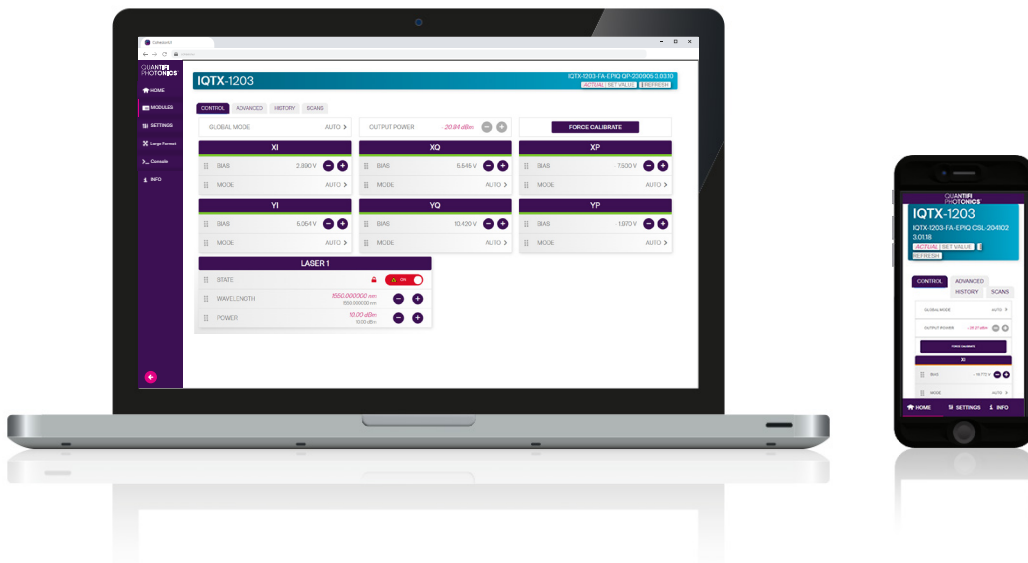
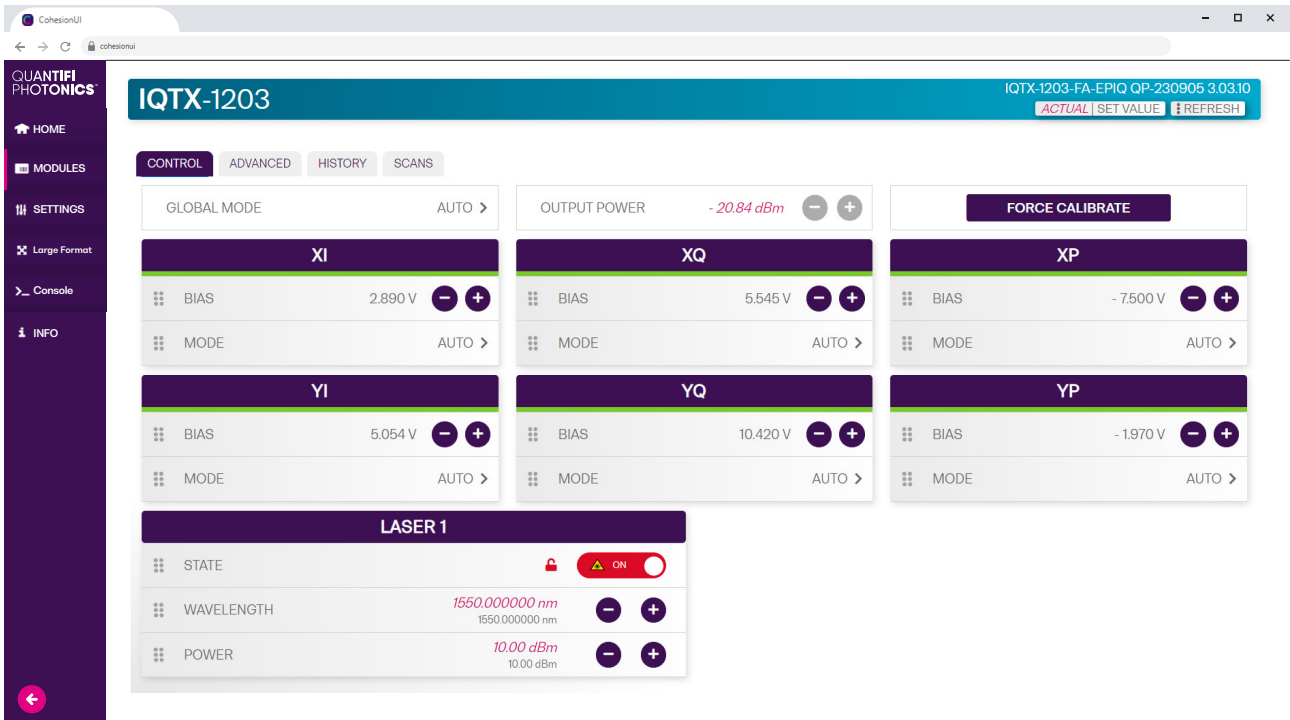

## Single polarization with dual polarization emulator

The single polarization IQTX is a cost-effective solution - generating emulated dual-polarization phase modulated signals with just two RF input channels.

The emulated dual-polarization IQTX can generate dual-polarization phase modulated signals by optically polarization multiplexing a delayed copy of the single-polarization modulated signal. The two RF inputs can be driven by differential outputs of a single channel data source.

So with the emulated dual-polarization generator you can create DP-QPSK signals using two differential outputs of a single channel PPG - significantly reducing costs in applications which do not require independent data.

## Standard features

- 20 GHz or 11 GHz of system bandwidth
- Emulated dual-polarization generator
- High bandwidth of up to 20 GHz (typical)
- 2 x high speed RF signal inputs
- Automatic Bias Control via the dedicated software controller
- Built-in C-band narrow linewidth tunable laser
- High bandwidth linear RF amplifiers

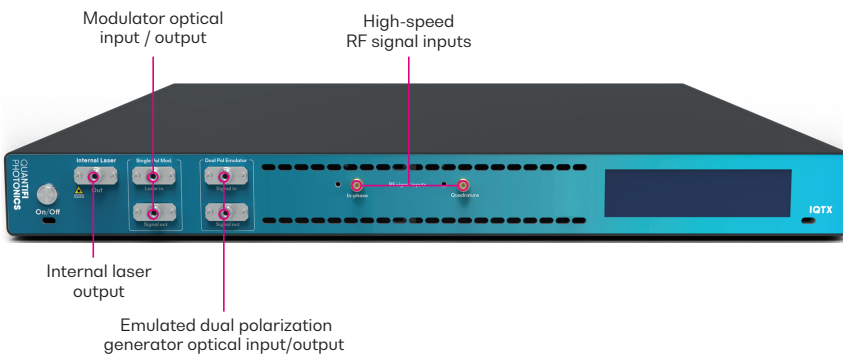

## 1100 Series Schematic Diagram

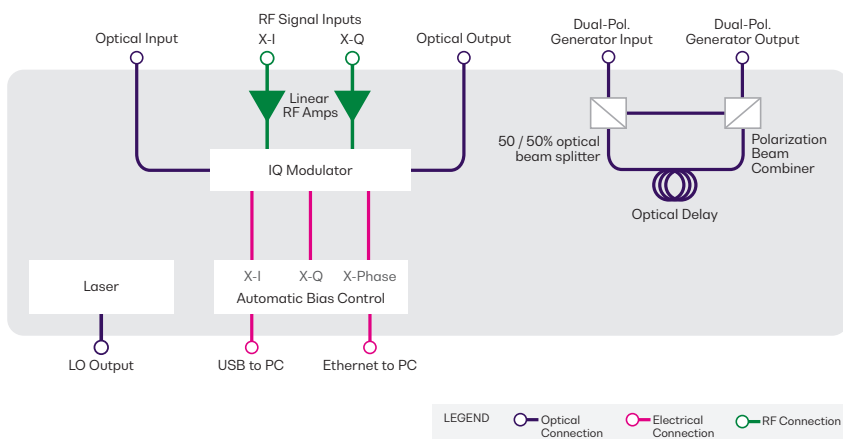



## Full Dual Polarization

The dual-polarization IQTX is a leader in its class; providing more capability, more flexibility and greater ease of use.

For applications requiring loading and transmission of true data, the dual-polarization IQTX provides capability to transmit independent data on all four tributary RF channels. The full dual-polarization IQTX is compatible with any 4 channel PPG or AWG; and a wide range of options are available to optimize your investment.

## Standard Features

- 40 GHz, 23 GHz or 11 GHz of system bandwidth
- 4 x high speed RF signal inputs
- Automatic Bias Control via the dedicated software controller
- Built-in C-band narrow linewidth tunable laser
- Automatic software modulator bias control
- High bandwidth linear RF amplifiers

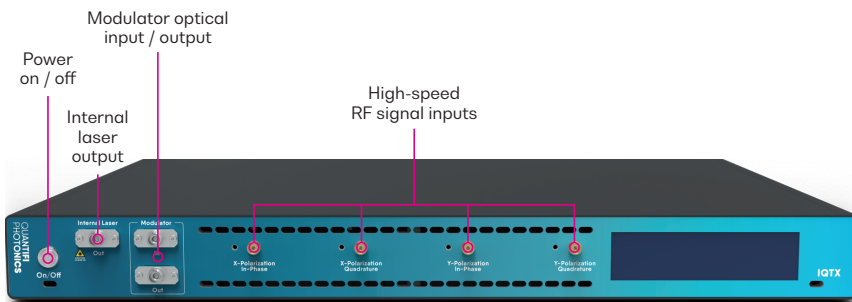

## 1200 Series Schematic Diagram

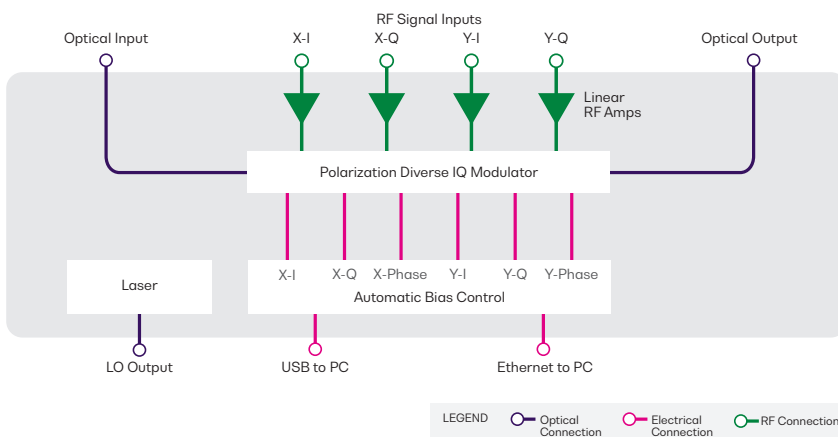

## IQTX TECHNICAL SPECIFICATIONS

General Specifications	IQTX
PC interface	USB 2.0, Ethernet
Operating system requirements	Windows 7, 8 or 10 (32 or 64 bit)
Dimensions (H x W x D)	44.1 x 440 x 528 mm   1.7 x 17.3 x 20.8 inches
Weight	~7.8 kg   17.2 lbs
Operating temperature range	5 °C to 40 °C   41 °F to 104 °F
Storage temperature range	-40 °C to 70 °C   -40 °F to 158 °F

## IQTX 1100 Series - Emulated dual polarization

Modular specifications	1101	1102
Modulator type	Single-polarization LiNbO <sub>3</sub> IQ Modulator	Single-polarization LiNbO <sub>3</sub> IQ Modulator
Wavelength range	1528 to 1612 nm	1528 to 1612 nm
Insertion loss <sup>5</sup>	< 8.0 dB	< 8.0 dB
DC extinction ratio	> 20 dB	> 20 dB
Maximum optical input power	13 dBm	13 dBm
Input optical connector type	PM FC/PC, PM FC/APC	PM FC/PC, PM FC/APC
Output optical connector type	PM FC/PC, PM FC/APC	PM FC/PC, PM FC/APC
RF bandwidth	11 GHz (Typical)	20 GHz (Typical)
Low frequency cutoff	< 100 kHz	< 40 kHz
Number of RF inputs	2	2
RF connector type RF	2.92 mm female	2.92 mm female
RF V <sub>pi</sub> @1GHz	200 mV (Typical)	200 mV (Typical)
Maximum RF input voltage	800 mV	500 mV

Dual polarization emulator	1101	1102
Insertion loss	< 2 dB	< 2 dB

ABC Specifications	1101	1102
Supported modulation formats	Any coherent modulation format	Any coherent modulation format
Bias control options	Automatic and manual control for individual biases	Automatic and manual control for individual biases
Maximum bias voltage range	28 V	28 V
Number of bias control channels	6	6
Startup time until settled	< 3 minutes (< 1 minute Typical)	< 3 minutes (< 1 minute Typical)
Quadrature error	Averaged mean < ± 0.3°, Standard deviation > 24 hours: < 2°	Averaged mean < ± 0.3°, Standard deviation > 24 hours: < 2°
ABC impact on EVM	< 1%	< 1%

## IQTX TECHNICAL SPECIFICATIONS

Laser Specifications	1101	1102
Tunable laser type	Thermally tuned External Cavity Diode Laser (ECDL)	Thermally tuned External Cavity Diode Laser (ECDL)
Tunable frequency range	1530 to 1565 nm	1530 to 1565 nm
Frequency tuning resolution (wavelength) <sup>2</sup>	1 MHz (~0.01 pm)	1 MHz (~0.01 pm)
Tuning time	< 25 s	< 25 s
Maximum output power	+ 15 dBm	+ 13 dBm
Optical power uncertainty after calibration <sup>2</sup>	± 0.4 dB	± 0.4 dB
Power stability over 24 hours	± 0.03 dB (Typical)	± 0.03 dB (Typical)
Power flatness over entire wavelength range	± 0.25 dB	± 0.25 dB
Output power tuning resolution	0.01 dB	0.01 dB
Power monitoring	Built-in	Built-in
Polarization extinction ratio at the PM fiber output	> 20 dB	> 20 dB
Relative intensity noise RIN (for 13 dBm)	-145 dB/Hz (10 MHz - 40 GHz)	-145 dB/Hz (10 MHz - 40 GHz)
Linewidth (FWHM), instantaneous <sup>4</sup>	< 100 kHz (25 kHz Typical)	< 100 kHz (25 kHz Typical)
Side-mode suppression ratio	40 dB (55 dB Typical)	40 dB (55 dB Typical)
Relative frequency accuracy <sup>4</sup>	± 1.5 GHz	± 1.5 GHz
Absolute frequency accuracy <sup>4</sup>	± 2.5 GHz	± 2.5 GHz
Frequency stability (wavelength) over 24 hours <sup>3</sup>	± 0.3 GHz (± 3 pm)	± 0.3 GHz (± 3 pm)

## IQTX 1200 Series - Full dual polarization

Modulator Specifications	1201	1202	1203
Modulator type	LiNbO <sub>3</sub> IQ Modulator	LiNbO <sub>3</sub> IQ Modulator	LiNbO <sub>3</sub> IQ Modulator
Wavelength range	1528 to 1612 nm	1528 to 1612 nm	1528 to 1612 nm
Insertion loss <sup>5</sup>	< 10 dB	< 10 dB	< 10 dB
DC extinction ratio	> 20 dB	> 20 dB	> 20 dB
Maximum optical input power	+ 18 dBm	+ 18 dBm	+ 16 dBm
Input optical connector type	PM FC/PC, PM FC/APC	PM FC/PC, PM FC/APC	PM FC/PC, PM FC/APC
Output optical connector type	PM FC/PC, PM FC/APC	PM FC/PC, PM FC/APC	SMF FC/PC, SMF FC/APC
RF bandwidth	11 GHz (Typical)	23 GHz (Typical)	40 GHz (Typical)
Low frequency cutoff	< 100 kHz	< 40 kHz	< 60 kHz
Number of RF inputs	4	4	4
RF connector type RF	2.92 mm female	2.92 mm female	1.85 mm female
RF V <sub>pi</sub> @1GHz	200 mV (Typical)	200 mV (Typical)	200 mV (Typical)
Maximum RF input voltage	800 mV	500 mV	500 mV

## IQTX TECHNICAL SPECIFICATIONS

ABC Specifications	1201	1202	1203
Supported modulation formats	Any coherent modulation format	Any coherent modulation format	Any coherent modulation format
Bias control options	Automatic and manual control for individual biases	Automatic and manual control for individual biases	Automatic and manual control for individual biases
Maximum bias voltage range	28 V	28 V	28 V
Number of bias control channels	6	6	6
Startup time until settled	< 3 minutes (< 1 minute Typical)	< 3 minutes (< 1 minute Typical)	< 3 minutes (< 1 minute Typical)
Quadrature error	Averaged mean: < $\pm 0.3^\circ$ , Standard deviation: > 24 hours: < $2^\circ$	Averaged mean: < $\pm 0.3^\circ$ , Standard deviation: > 24 hours: < $2^\circ$	Averaged mean: < $\pm 0.3^\circ$ , Standard deviation: > 24 hours: < $2^\circ$
ABC impact on EVM	< 1%	< 1%	< 1%

Laser Specifications	1201	1202	1203
Tunable laser type	Thermally tuned External Cavity Diode Laser (ECDL)	Thermally tuned External Cavity Diode Laser (ECDL)	Thermally tuned External Cavity Diode Laser (ECDL)
Tunable frequency range	1530 to 1565 nm	1530 to 1565 nm	1530 to 1565 nm
Frequency tuning resolution (wavelength) <sup>2</sup>	1 MHz (~0.01 pm)	1 MHz (~0.01 pm)	1 MHz (~0.01 pm)
Tuning time	< 25 s	< 25 s	< 25 s
Maximum output power	+ 15 dBm	+ 15 dBm	+ 15 dBm
Optical power uncertainty after calibration <sup>2</sup>	$\pm 0.4$ dB	$\pm 0.4$ dB	$\pm 0.4$ dB
Power stability over 24 hours	$\pm 0.03$ dB (Typical)	$\pm 0.03$ dB (Typical)	$\pm 0.03$ dB (Typical)
Power flatness over entire wavelength range	$\pm 0.25$ dB	$\pm 0.25$ dB	$\pm 0.25$ dB
Output power tuning resolution	0.01 dB	0.01 dB	0.01 dB
Power monitoring	Built-in	Built-in	Built-in
Polarization extinction ratio at the PM fiber output	> 20 dB	> 20 dB	> 20 dB
Relative intensity noise RIN (for 13 dBm)	-145 dB/Hz (10 MHz - 40 GHz)	-145 dB/Hz (10 MHz - 40 GHz)	-145 dB/Hz (10 MHz - 40 GHz)
Linewidth (FWHM), instantaneous <sup>3</sup>	< 100 kHz (25 kHz Typical)	< 100 kHz (25 kHz Typical)	< 100 kHz (25 kHz Typical)
Side-mode suppression ratio	40 dB (55 dB Typical)	40 dB (55 dB Typical)	40 dB (55 dB Typical)
Relative frequency accuracy <sup>4</sup>	$\pm 1.5$ GHz	$\pm 1.5$ GHz	$\pm 1.5$ GHz
Absolute frequency accuracy <sup>4</sup>	$\pm 2.5$ GHz	$\pm 2.5$ GHz	$\pm 2.5$ GHz
Frequency stability (wavelength) over 24 hours <sup>4</sup>	$\pm 0.3$ GHz ( $\pm 3$ pm)	$\pm 0.3$ GHz ( $\pm 3$ pm)	$\pm 0.3$ GHz ( $\pm 3$ pm)

### Notes

1. Specifications are valid at 23 °C  $\pm$  3 °C.
2. At maximum output power.
3. The laser uses a small FM dithering as part of its wavelength locking mechanism. The instantaneous linewidth is measured in 1 ms (integration time).
4. Varies slightly according to wavelength.
5. At maximum transmission bias setting.

## ORDERING INFORMATION

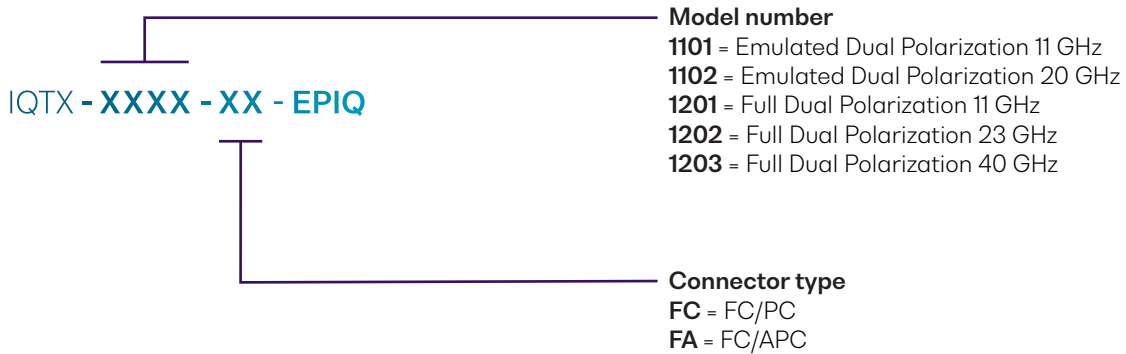

## ACCESSORIES

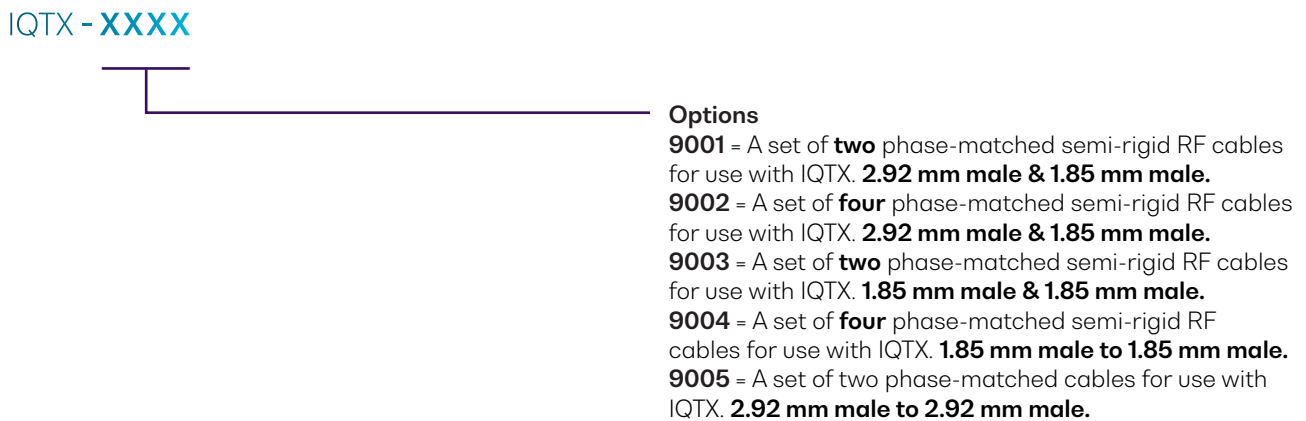

## WARRANTY INFORMATION

This product comes with a standard 1 year warranty.

## EXTENDED WARRANTIES AND CALIBRATION PLANS

With an **extended warranty and calibration plan** you'll spend more time focused on your priorities and less time worrying about maintenance.

Your choice: add a **3 or 5 year extended warranty** when you buy.



### Guarantee performance

Ensure your equipment is operating at the best it can be for reliable and accurate results.

### Lower cost of ownership

Lock in savings and maximise your testing budget with a lower base cost of ownership.

### Peace of mind

Spend less time worrying about maintenance and more on generating results.

## CALIBRATION PLANS FOR ADDITIONAL DISCOUNTS

Order a **calibration plan** when purchasing your Quantifi Photonics instruments and get additional discounts.

### 10% Discount

On calibrations ordered at the time of purchase.

### 25% Discount

Add on an extended warranty and receive a 25% discount on calibrations.

Over time and with regular use, all optical parts and connectors require re-calibration and maintenance to guarantee accurate and reliable performance. We recommend Quantifi Photonics optical instruments are re-calibrated every 12 months. With an instrument calibration performed by Quantifi Photonics technicians you receive:

- Comprehensive calibration to factory specifications
- End-to-end inspection to ensure all instrument functions are working and connectors are clean
- Firmware, software and documentation updates
- Certificate of calibration which includes detailed test results

## How to do I secure my extended warranty or calibration plan?

Contact your Quantifi Photonics sales representative or email [sales@quantifiphotonics.com](mailto:sales@quantifiphotonics.com)

Extended warranties and calibration plans must be ordered at the time of purchase and are available only for Quantifi Photonics' products. The 25% calibration discount only applies to calibrations while the product is covered by the extended warranty period.

Our portfolio of optical & electro-optical test modules is rapidly expanding to meet a wide range of customer requirements and applications.

**Tunable Laser Sources**

Versatile telecom laser sources with full tunability across C or L bands. Narrow 100 kHz linewidth, up to 16.5 dBm of power, optional whisper mode to disable frequency dither.



**Fixed Wavelength Laser Sources**

Highly customizable laser platform. Select required wavelength, power and fiber type for a customized solution.



**Swept, Tunable Continuous Wave Laser**

Swept, tunable continuous wave (CW) laser source with 0.01 dB power stability and 400 nm/s high-speed scan rate for R&D and production testing.



**Superluminescent Diode Broadband Light Source**

Super-luminescent LED light source with high output power, large bandwidth and low spectral ripple and various wavelengths.



**Optical-to-Electrical Converter**

High bandwidth, broadband O-to-E converter. Available in a range of configurations; choose from 1 or 2 channels, AC or DC coupling and various conversion gain and operating wavelength ranges.



**Variable Optical Attenuator (VOA)**

Fast attenuation speed with low insertion loss and built-in power monitoring. Operates in fixed attenuation or constant output power modes. Models support SMF, MMF and PMF connector types.



**Polarization Controller & Scrambler**

High-speed automated polarization control with broad wavelength coverage from 1260nm to 1650nm, low insertion loss and back reflection. Full remote control via intuitive GUI, LabVIEW or SCPI.



**Optical Power Meters**

Fast terminating or inline monitoring of optical signal power from -60 to +10 dBm across 750 - 1700 nm wavelengths. Model with logarithmic analog output for applications such as silicon photonics fiber alignment.



**Bit Error Rate Tester (BERT)**

4 or 8-channel Pulse Pattern Generator and Error Detector at rates up to 29 Gbps for the design, characterization and production of optical transceivers and opto-electrical components.



**Optical Spectrum Analyzer (OSA)**

Cost-effective, spectral measurement in a compact module with built-in analysis for: SMSR, OSNR & spectral width. Targeted wavelengths for specific applications in O band, C band & L band.



**Passive Component Integration**

Integrate passive optical components of your choice such as WDM couplers, splitters, band-pass filters, PM beamsplitters and circulators. Models support SMF, MMF and PMF.



**Passive Component Storage**

Protect and store your own passive fiber optic components such as splitters, connector adaptor patchcords, WDM couplers, and isolators in one handy module.



**Photonic Doppler Velocimeter (PDV)**

Purpose-built module for Photonic Doppler Velocimetry (PDV). A circulator, two VOAs and a passive coupler all built into one compact module.



**Optical Switch**

Proven reliability and fast switching time. Wide variety of switch configurations: 1x4, 1x16, 16x16 and more. Models support SMF, MMF and PMF.



PXI - MODULAR SYSTEM

MATRIQ - COMPACT BENCHTOP

See our website for more details  
[quantifotonics.com/products](http://quantifotonics.com/products)

# Test. Measure. Solve.<sup>TM</sup>

Quantifi Photonics is transforming the world of photonics test and measurement. Our portfolio of optical and electrical test instruments is rapidly expanding to meet the needs of engineers and scientists around the globe. From enabling ground-breaking experiments to driving highly efficient production testing, you'll find us working with customers to solve complex problems with experience and innovation.

**To find out more, get in touch with us today.**

<b>General Enquiries</b>	<a href="mailto:sales@quantifiphotonics.com">sales@quantifiphotonics.com</a>
<b>Technical Support</b>	<a href="mailto:support@quantifiphotonics.com">support@quantifiphotonics.com</a>
<b>Phone - NZ</b>	+64 9 478 4849
<b>Phone - USA</b>	+1-800-803-8872

[quantifiphotonics.com](https://www.quantifiphotonics.com)

**QUANTIFI  
PHOTONICS®**