

# CENTURION+

Compact pulsed diode-pumped Nd:YAG laser



## MAIN FEATURES

- Full energy output from very first shot
- Electronics embedded
- Optional variable attenuator inside housing
- Harmonic generators (532 nm, 355 nm, 266 nm) integrated internally
- 1.57  $\mu\text{m}$  eye-safe operation available
- Very homogenous near field intensity distribution
- Excellent energy stability at all wavelengths
- Low vibration fans
- Fiber coupling available at 1064 nm and 532 nm

## MAIN APPLICATIONS

- FPD REPAIR
- SEMICONDUCTOR PROCESS
- LiDAR
- LIBS
- OPO AND Ti:SA PUMPING

## Typical beam profiles

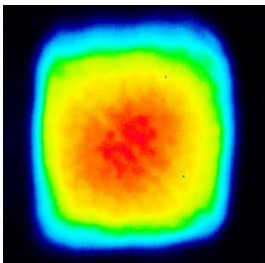

Near field 50 mJ @ 1064 nm,  
100 Hz

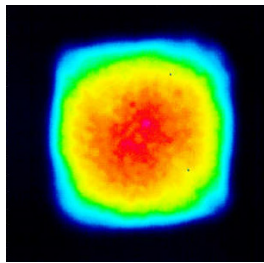

Near field 25 mJ @ 532 nm,  
100 Hz

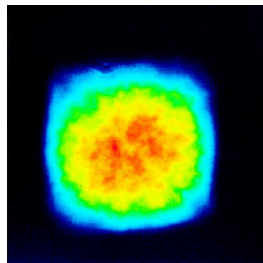

Near field 8 mJ @ 355 nm,  
100 Hz

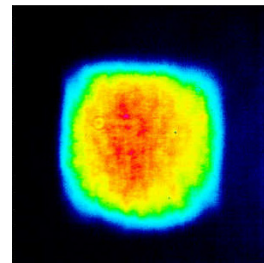

Near field 2.5 mJ @ 266 nm,  
100 Hz

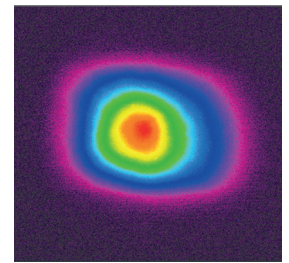

Near field 10 mJ @ 1570 nm,  
100 Hz

1.1/22-REV E - Lumibird reserves the right to modify the specifications without prior notice.

[www.quantel-laser.com](http://www.quantel-laser.com)

Many options and configurations are available. Please contact Lumibird to find the best match for your needs and compatibility between options.



Lumibird has locations across the globe that are available to provide support for any product, service or inquiry. Visit [www.lumibird.com](http://www.lumibird.com) to connect with any of our global sites.



# CENTURION+

Compact pulsed diode-pumped Nd:YAG laser



## SPECIFICATIONS

CENTURION+				
Repetition rate (Hz)	1-100			
Energy per pulse (mJ)	Main wavelength		Residuals	
			532 nm	1064 nm
	1064 nm	50	-	-
	532 nm	25	-	15
	355 nm	8	6	20
Pulse duration (ns) <sup>(1)</sup>	266 nm	2.5	12	12
	1570 nm	10	-	-
	1064 nm	< 14		
	532 nm	< 13		
Beam diameter (mm) <sup>(2)</sup>	355 nm	< 12		
	266 nm	< 12		
	1570 nm	< 8		
	1064 nm	3.5 ± 0.5		
	532 nm	3.2 ± 0.5		
Beam divergence (mrad) <sup>(3)</sup>	355 nm	3.0 ± 0.5		
	266 nm	3.0 ± 0.5		
	1570 nm	3.0 ± 0.5		
	1064 nm	< 9		
	532 nm	< 8		
Polarization <sup>(4)</sup>	355 nm	< 7		
	266 nm	< 6		
	1570 nm	< 6		
	All wavelengths	Vertical		
Polarization extinction ratio	1064 nm	150 : 1		

- (1) Measured at FWHM with fast photodiode and 1 GHz scope
- (2) D4σ at output window
- (3) D4σ, full angle
- (4) Polarization is given for final wavelength

Pulse to pulse energy stability (%) <sup>(1)</sup>	1064 nm	≤ 2 (0.5)
	532 nm	≤ 2.5 (1)
	355 nm	≤ 4.5 (1.5)
	266 nm	≤ 4.5 (1.5)
	1570 nm	≤ 5 (1.5)
First shot energy stability (%) <sup>(2)</sup>	1064 nm	≤ 2 (0.5)
	532 nm	≤ 2.5 (1)
	355 nm	≤ 3.5 (1.2)
	266 nm	≤ 3.5 (1.2)
	1570 nm	≤ 2 (1)
Energy drift (%) <sup>(3)</sup>	1064 nm	≤ 5
Pointing stability (μrad) <sup>(4)</sup>	1064 nm	≤ 100
Linewidth (cm <sup>-1</sup> )	1064 nm	≤ 1

- (1) Peak-to-peak (RMS), measured on 6000 shots from turn-on at 100 Hz
- (2) Peak-to-peak (RMS), measured on 5 sets of 20 consecutive shots from turn-on at 1 Hz
- (3) Measured over 5 minutes
- (4) Measured at 1064 nm on the first 1000 consecutive shots at 100 Hz

## OTHER INFORMATION

Power requirements	Laser head	48 ± 10 % VDC, 5 A
	Optional control box	100-240 VAC, 50/60Hz, 250 VA
Cooling	Air cooled	
Operating temperature	15 °C to 35 °C	
Storage temperature	5 °C to 60 °C	
Laser head sealing	IP 51 sealed	
Vibration and shock	Complies with MIL-STD-810	
Diode warranty	1 billion shots	

## Laser head & electronics

## OPTIONS

### Wavelength separation module

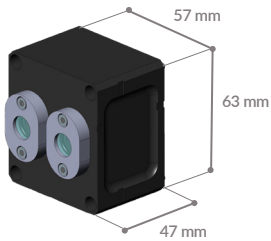

### 4 colours

Wavelength (nm)	266	355	532	1064
Energy per pulse (mJ)	2	2.2	12	12

### Remote box



### Fiber optic launch adaptor

Dimensions for 1064 nm version

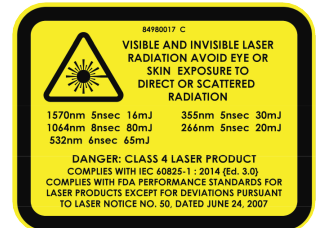
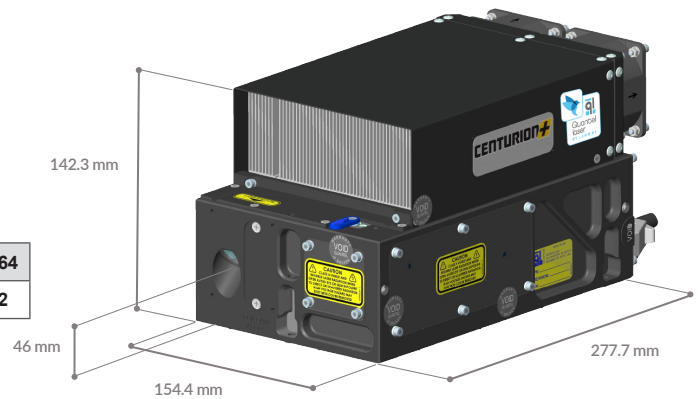
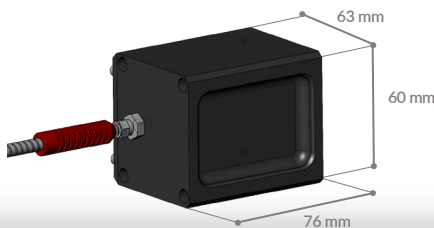

[www.quantel-laser.com](http://www.quantel-laser.com)

Many options and configurations are available. Please contact Lumibird to find the best match for your needs and compatibility between options.



Lumibird has locations across the globe that are available to provide support for any product, service or inquiry. Visit [www.lumibird.com](http://www.lumibird.com) to connect with any of our global sites.

