

Applications

- Absorption / transmission / reflection measurement systems.
- Operable as an excitation light source in fluorescence measurement systems
- Eye protection products measurement system
- PEC photochemistry measurement systems
- Solar cell quantum efficiency measurement systems

Features

- Monochromatic light from 300 nm up to 1800 nm
- Collimated, condensed, or coupled output light options. Light can be coupled to any optical system (including fibers and fiber bundles)
- Adjustable optical resolution from 20 nm down to 0.2 nm
- Flexibility of optional features: full automation, various sources and monochromators and more.
- Computer-controlled.



TUNABLE LIGHT SOURCES

Tunable Light Sources

OVERVIEW

Sciencetech offers a series of computer-controlled adjustable sources of monochromatic light, our Tunable Light Source (TLS) line. Each TLS system is pre-aligned at the Sciencetech test lab and packaged with the system's test data and detailed manual. Sciencetech's tunable light sources are motorized instruments controlled by Sciencetech's Windows based software. LabView drivers, ActiveX and DotNet modules are also available making the TLS a flexible system for integration with your experiment or instrument.

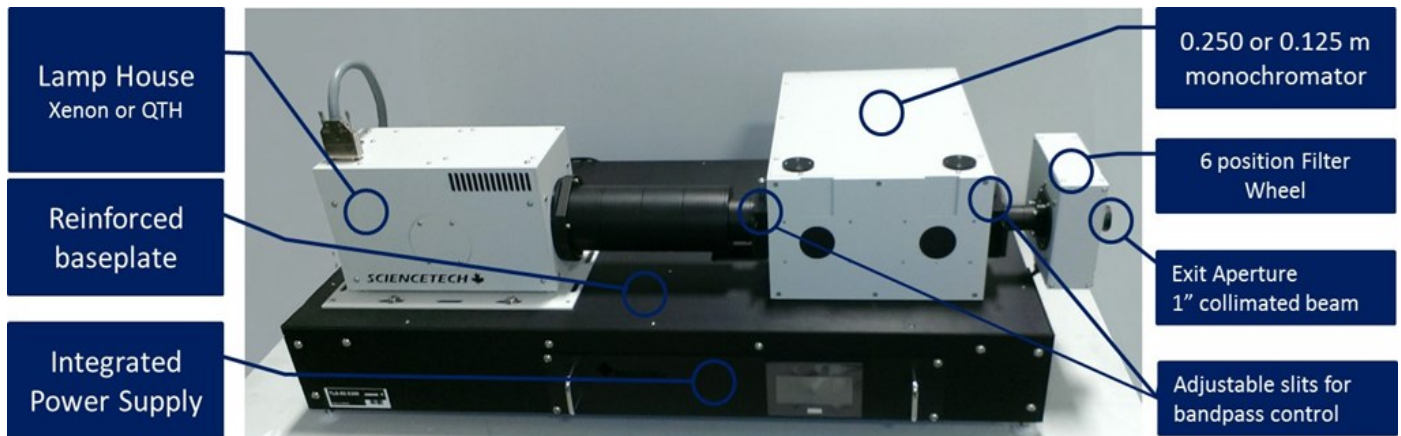

Standard Features

Each base model comes with standard features:

- Sciencetech Light Source Xe or QTH
- 1" collimated light output
- Sciencetech Monochromator, three grating turret with two gratings
- Adjustable slits for optical bandpass control
- Motorized filter wheel with 4 long pass filters installed.
- Adjustable computer controlled power supply (Xenon lamps only).
- SciSpec software for controlling the monochromator and filter wheel.
- Reinforced optical base plate.

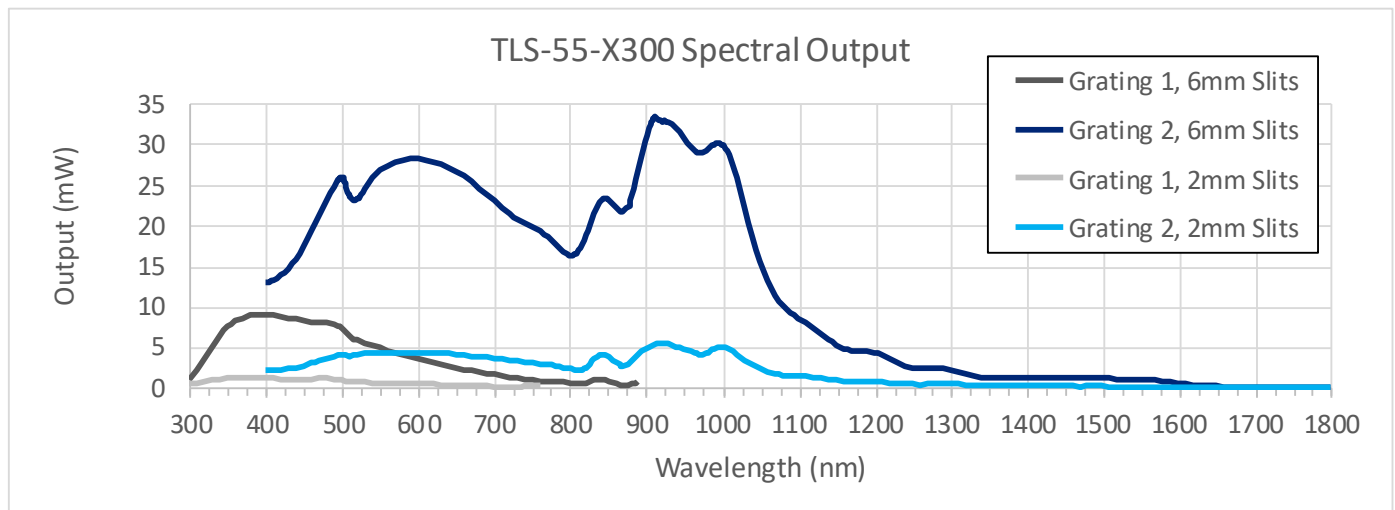

Typical output power of the TLS-X55-300 (Xe lamp 300 W) with various gratings and slits

Tunable Light Sources

SPECIFICATIONS

Sciencetech's software, Sci-Spec, controls all components of the system. In the standard configuration, it controls the power supply of the light source, shutter, filter wheel, and monochromator. As an option, the user can add computer control on the input and output slits, and/or control of the iris. In the standard configuration, the output beam can be collimated or focused. Coupling with different devices is available as an option, such as coupling with a sample chamber, fiber, or fiber bundle.

Customized Solutions

Sciencetech TLS systems are built with modular components making them flexible and adaptable well beyond the standard models offered.

All components of the system, including the light source and monochromator can be customized. Available options include:

- Xe, Xe-Hg and Hg lamps from 75W-1.6 kW
- QTH lamps 50 W-500 W
- Dual deuterium/QTH source
- Mid-IR sources up to 1700 Kelvin
- Available spectral range 180 nm – 10 um (Light source, optics and grating dependent)
- Double subtractive and double additive monochromators
- Monochromators up to 1 meter focal length
- Motorized or manual iris
- Optical light feedback for additional source stabilization (only available with Xe and Xe-Hg lamps)
- Detectors and data acquisition systems can be provided as add-ons
- Can be coupled with Integrating Spheres, samples chambers and other opto-mechanical components upon request

MODELS	TLS-72-X300	TLS-72-Q250	TLS-55-X300	TLS-55-Q250
Lamp Type	Xe 300 W	QTH 250 W	Xe 300 W	QTH 250 W
Monochromator Type	9072S (1/8 meter)		9055 (1/4 meter)	
Functional Spectral range	300-1800 nm			
Optical resolution	0.5 nm @ 300-700 nm		0.2 nm @ 300-700 nm	
	0.7 nm @ 700-1800 nm		0.4 nm @ 700-1800 nm	
Filter wheel with filter set	Computer-controlled 6-position filter wheel			
Shutter	Optional computer-controlled shutter and exposure control			
Beam output	1" diameter collimated			
Wavelength Repeatability	0.1 nm		0.03 nm	
Wavelength Accuracy	0.2 nm			
Intensity Control	Source intensity adjustable. Optional manual iris			
Gratings	2 plane ruled gratings 30x30 mm		2 plane ruled gratings 50x50 mm	
	1200 gr/mm@300nm 600 gr/mm@1000nm		1200 gr/mm@300nm 600 gr/mm@1000nm	
Bandpass	Two manual bilaterally-adjustable slits with vertical curtain attenuators			
Optical Height	216 mm (adjustable +/- 5 mm)			
Power supply	Touchscreen, Constant Current	Manual, Constant Current	Touchscreen, Constant Current	Manual, Constant Current
Software	Sci-Spec (Labview examples, DotNet, Active X also available)			
Computer Interface	USB—monochromator and filter wheel , RS232 Power Supply (xenon lamp only)			
CE Certification	IEC 61010-1:2010 Safety Requirements for electrical equipment for measurement, control and laboratory use—Part 1			
	IEC 61326-1:2012 Electrical equipment for measurement, control and laboratory use—EMC requirements—Part 1			

Tunable Light Sources

OPTIONAL UPGRADES

Various output accessories can be fitted to the monochromator input/output to customize the system for different applications either as a stand-alone unit or to be used in conjunction with other optical devices and systems. Browse the below options to see if any other upgrades and accessories might be required for your application.

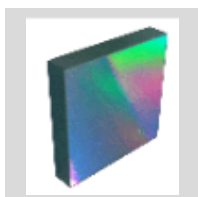

Gratings

Choose the most suitable gratings to be used with your TLS to optimize light output according to your wavelengths of interest.

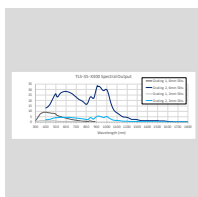

TLS CAL Package

(810-0010)

This service provides light output characterization and optical power emission from 200-1800nm. Also assesses Beam divergence and light source stability.



Motorized Slit(s)

(120-9053)

The SS-80 is a motorized adjustable slit for the input or output port of a Sciencetech monochromator.(FS-02-N) Light Intensity Stabilizer



Fiber optic light cables

Various fiber optic cables and light guides can be coupled to input or output slits of the tunable light source.

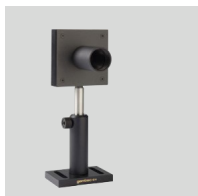

Detectors (Single or multi channel)

Allows the measurement of light at output slits of the system.

Tunable Light Sources

OPTIONAL UPGRADES

Various output accessories can be fitted to the monochromator input/output to customize the system for different applications either as a stand-alone unit or to be used in conjunction with other optical devices and systems. Browse the below options to see if any other upgrades and accessories might be required for your application.

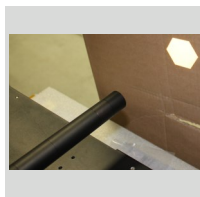

Homogenizing light pipe

Homogenizing light pipes can be coupled to the output slit of the TLS to provide a highly spatially uniform light output on the target.



Integrating Spheres

Integrating spheres can be coupled to output slits of the TLS.



Dual input/output slit upgrades

Allow the use of second input/output ports with the use of switching mirrors. Only applicable for TLSs with 9055 monochromators.



Beam splitter

Beam splitters can be installed to split the input or output beams to direct to various detectors and other optomechanical instruments.



Light Intensity Stabilizer

The FS-02-N is an upgrade for the touchscreen power supply and the associated lamp house.

Tunable Light Sources

DIMENSION

Dimensions are in [mm].

9055 Monochromator-Type:

The dimensions of the Sciencetech Tunable Light Sources are different for different models, but the 9055 monochromator based model has the following dimensions in millimeters.

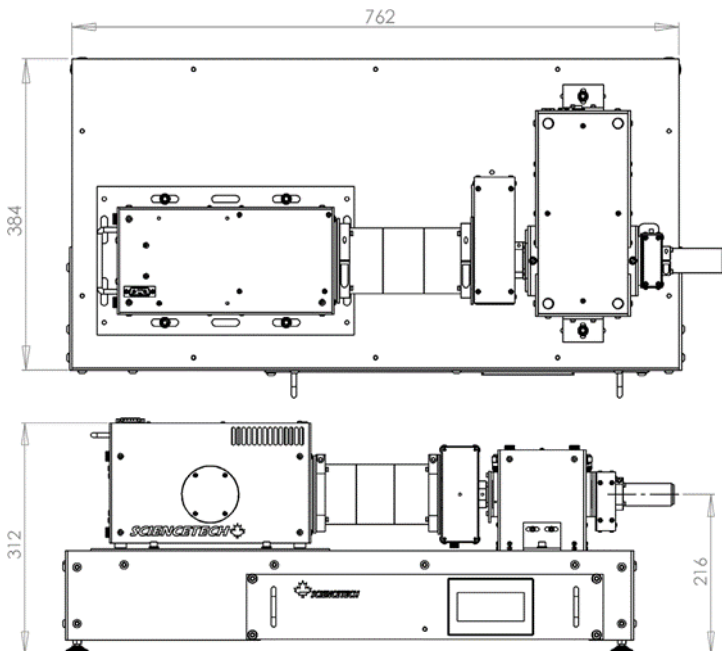
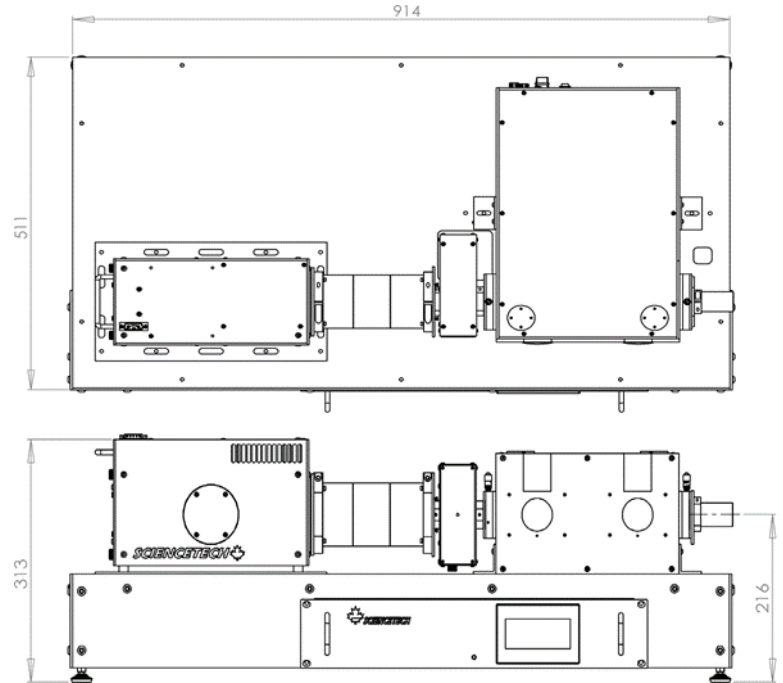

9072 Monochromator-Based:

Left: The dimensions of the Sciencetech Tunable Light Sources are different for different models, but the 9072 monochromator based model has the following dimensions in millimeters.

For TLS-55-X300-SS dimensions please contact a Sciencetech Application Scientist.