



LCC7201 Birefringence Imaging System

User Guide



















Table of Contents

Chapter 1	Warning Symbol Definitions.....	1
Chapter 2	Safety.....	2
Chapter 3	Description.....	3
3.1.	<i>Introduction</i>	3
3.2.	<i>Parts List – Accessories</i>	3
Chapter 4	Setup	5
4.1.	<i>Unpacking</i>	5
4.2.	<i>Identification and Function of System Components</i>	5
	Optical Components	6
	Imaging Mode Selector Knob	6
	Sample Holder	6
	Sample Stage	7
	Focus Adjustment Ring	7
4.3.	<i>System Information and Connections</i>	7
4.4.	<i>System Installation</i>	9
Chapter 5	System Operation.....	10
5.1.	<i>Starting the System</i>	10
5.2.	<i>Software GUI</i>	11
	5.2.1. Main Menu	11
	5.2.2. Image Preview Window	12
	5.2.3. Preview Setting	12
	5.2.4. Status Bar	14
	5.2.5. Measurement Control	14
	5.2.6. Measurement Data Views	16
Chapter 6	Maintenance.....	21
6.1.	<i>Basic Care</i>	21
6.2.	<i>Service</i>	22
Chapter 7	Specifications	23
7.1.	<i>Mechanical Drawings</i>	24
Chapter 8	Trouble Shooting.....	26
Chapter 9	CE/FCC Certification	27
Chapter 10	Regulatory.....	29
Chapter 11	Thorlabs Worldwide Contacts	30

Chapter 1 Warning Symbol Definitions

Below is a list of warning symbols you may encounter in this manual or on your device.

Symbol	Description
	Direct Current
	Alternating Current
	Both Direct and Alternating Current
	Earth Ground Terminal
	Protective Conductor Terminal
	Frame or Chassis Terminal
	Equipotentiality
	On (Supply)
	Off (Supply)
	In Position of a Bi-Stable Push Control
	Out Position of a Bi-Stable Push Control
	Caution: Risk of Electric Shock
	Caution: Hot Surface
	Caution: Risk of Danger
	Warning: Laser Radiation
	Caution: Spinning Blades May Cause Harm

Chapter 2 Safety



CAUTION



Except for the main fuse, which is accessible from the outside of the housing, LCC7201 has no user-serviceable parts. Service should only be performed by trained service personnel.



SHOCK WARNING



High voltage inside. To avoid electrical shock, before powering up, make sure that the ground pin of the power cord is correctly connected to the ground connector in the power socket. Improper grounding can cause electric shock resulting in severe injury or even death. Do not operate without the cover installed.



WARNING



This unit must not be operated in explosive environments.



WARNING



Transportation and delivery may cause the LCC7201 to be warm or cool upon receipt. Please wait for the whole device to reach room temperature before attempting to operate.



WARNING



Do not operate in wet/damp conditions. Do not obstruct the air ventilation slots in the housing!

Chapter 3 Description

3.1. Introduction

This User Manual is written for the users of the Thorlabs LCC7201 Birefringence Imaging System. To ensure correct usage, read this manual carefully before operating your LCC7201.

3.2. Parts List – Accessories

The Birefringence Imaging System is carefully packed in a Pelican 1690 case. The complete system consists of an LCC7201 main unit and the following standard accessories:

- Bundled Laptop
- Laptop Power Adapter
- Main Unit Power Adaptor
- USB Drive with Software and Manual
- LAN Cable
- USB Cable
- Birefringent NBS 1963A Resolution Target, R2L2S1B
- LAN Card (for use with Desktop PC)
- Sample Holders for $\varnothing 0.5"$, $\varnothing 1"$ and $2" \times 2"$ Optics



Figure 1 Bundled Laptop



Figure 2 Laptop Power Adaptor



Figure 3 Main Power Adaptor



Figure 4 USB Drive with Software



Figure 5 LAN Cable



Figure 6 USB Cable



Figure 7 Birefringent NBS 1963A Resolution Target, R2L2S1B



Figure 8 LAN Card (for use with Desktop PC)

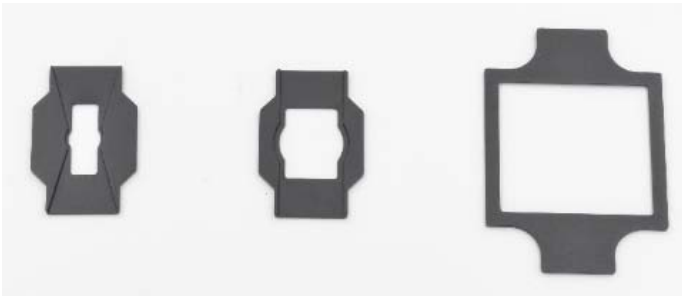

Figure 9 Sample Holders for $\varnothing 0.5''$, $\varnothing 1''$ and $2'' \times 2''$ Optics

Chapter 4 Setup

4.1. Unpacking

Open the Pelican case and check that all accessories are packed in the case according to the included packing list. To transfer the LCC7201 main unit to the table where it will be operated, it is recommended to lift the unit out of the pelican case with one hand holding the top and another hand holding the handle at the bottom, and then hold the unit upright and place it on your lab table or the ground. While transferring the unit from one place to another, please keep it upright and always hold both handles with the front side (with LCC7201 engraving) tipped towards the user. Lifting with other parts of the device is not recommended and may cause damage to the main unit and/or human injury.

After unpacking, store the packing cartons and the Pelican case. If the Birefringence Imaging System needs to be serviced or returned, it must be transported within the Pelican case.

4.2. Identification and Function of System Components



Figure 10 LCC7201 Main Unit

Optical Components

Standard systems use an integrated 633 nm LED as the light source. If a light source with a custom wavelength was selected, then it will be integrated instead.

All the optical components within the LCC7201 are designed and tuned for 633 nm, or the custom wavelength specified at the time of purchase. The configuration and positions are carefully aligned in the factory. There are no user serviceable components within the device.

A scientific grade camera is used to image the sample. The camera chip has 2048 x 2048 pixels. The imaging system provides a close-to-unity magnification where the camera sensor captures a $\varnothing 20$ mm field of view. Therefore the spatial resolution of the system is about 9.7 micron.

Imaging Mode Selector Knob

This knob is used to toggle the imaging mode during operation. It can be set in two positions:

Imaging Mode	Knob Position	Application
Measurement Mode	Pushed In	Measurement of Birefringent Sample
Preview Mode	Pulled Out	Imaging without Birefringent Dependency

The selector knob needs to be pushed in all the way, and remain in the pushed-in position, when carrying out a measurement with the software.

Sample Holder

The **MLS203P2** sample holder provides manual adjustment of sample viewing in the x-direction, and supports samples of different dimensions. In particular, three sample holder adaptors are bundled with the LCC7201, designed for $\varnothing 0.5$ ", $\varnothing 1$ " and 2" x 2" optics. An example showing a $\varnothing 1$ " optic mounted in the insert is shown below:



Figure 11 $\varnothing 1$ " Optics Insertion Example

Other customized sample holder adaptors are available. Please contact Thorlabs tech support.

Sample Stage

The pre-installed MLS203P2 can be replaced with Thorlabs' High-Speed Motorized XY Scanning Stage **MLS203-1** to scan larger samples. To replace the MLS203P2 with the MLS203-1, a 4 mm hex key or ball driver is needed to remove the M5 x 10 mm socket cap screws.

Focus Adjustment Ring

Adjusts the system focus for imaging different samples.

Focus Lock

Locks the user defined focus.

Status Bar

Indicates system status with different colors and status.

Status	Color	Bar Display
Power On	Blue	Scan Sequence
Initialization	Pink	Progress Bar
Warm Up	Pink	Full
Ready	Blue	Full
Measurement	Pink/Blue	Progress Bar
Error	Red	Full

Dust Cover

Prior to shipping, an **SM1CP2** dust cover is installed at the optical aperture of the top component. The cover should be used during transportation and when the unit is idle.

Lifting Handle

Two handles, placed on both left and right sides of the unit, are designed to allow the device to be lifted. To save space, the handles may be removed with a 3/16" ball driver or hex key while the device is stationary. However, they must be re-installed and used during transportation of the device.

4.3. System Information and Connections

The system information including serial number and manufactured data is found on the rear side of the device.

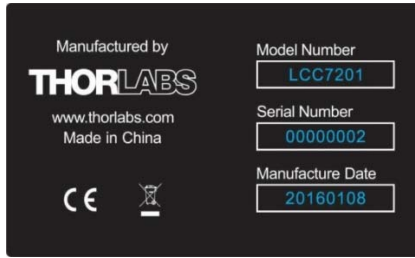

Figure 12 Information plate of LCC7201

All of the system connections are located at the bottom of the rear side. See figure below:



Figure 13 Rear of the LCC7201 Mainframe

Connections from left to right:

- Service Button (for Technical Support only)
- Power Adaptor Connector
- USB 2.0 Type B Connector to PC
- GigE RJ45 Connector to PC

The power switch of the system is located on the main unit power adaptor, shown below:



Figure 14 Main Power Adaptor for LCC7201 (Power Switch Included)

4.4. System Installation

To install the system before the operating the unit with the software, the following steps are needed:

- Connect the USB cable between the main unit and laptop.
- Connect the LAN Cable between the main unit and laptop.
- Connect the Power Adapter to the main unit.
- Connect the Power cord to the power adapter and connect the other end to a wall plug.
- Remove the dust cover from the device head.

Chapter 5 System Operation

5.1. Starting the System



SHOCK WARNING



High voltage inside. To avoid electrical shock, before powering up, make sure that the ground pin of the power cord is correctly connected to the ground connector in the power socket. Improper grounding can cause electric shock resulting in severe injury or even death. Do not operate without the cover installed.



WARNING



This unit must not be operated in explosive environments.



WARNING



Transportation and delivery may cause the LCC7201 to be warm or cool upon receipt. Please wait for the whole device to reach room temperature before attempting to operate.



WARNING



Do not operate in wet/damp conditions. Do not obstruct the air ventilation slots in the housing!

For proper initialization of the system, the following steps are needed:

- 1) Start the device by switching the power switch to the “I” position. Verify that the status bar is switched on. Wait 90 seconds while system initializes.
- 2) After powering on, the power bar turns purple and the system performs a warm up procedure which may take about 30 minutes. After that, the status bar turns blue, indicating that the system is ready.
- 3) Start the Thorlabs LCC7201 software and wait for the recognition of the hardware. It may take several seconds before the software is ready to connect.

5.2. Software GUI

The LCC7201 Software GUI is divided into 6 functional areas:

- Main Menu
- Preview Setting
- Image Preview Window
- Measurement Control
- View Tabs
- Status Bar

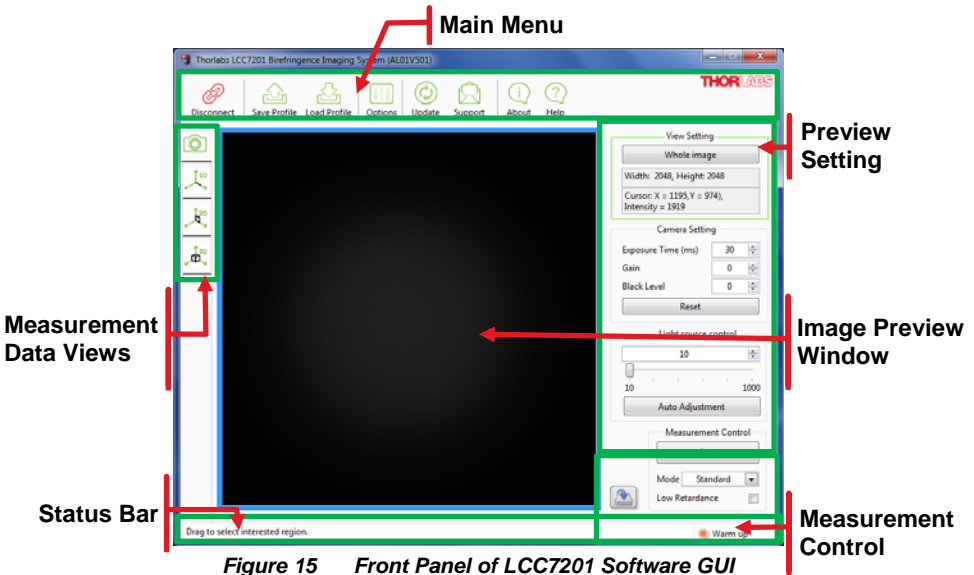

Figure 15 Front Panel of LCC7201 Software GUI

5.2.1. Main Menu

All the user operations can be done with items in the main menu area.

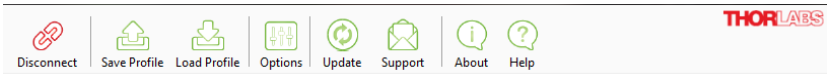

Figure 16 Main Menu Area of LCC7201 GUI

Connect/Disconnect

Enable or disable the connection between the LCC7201 and the PC. When the hardware is recognized, the connect button will be enabled for connection. If the connection button is grayed out, check that the power supply is turned on and the USB and LAN cables are both properly connected to the computer. Otherwise, please check for solutions in Chapter 8.

Save Profile

Save the user defined settings in XML format.

Load Profile

Load the user defined settings in XML format.

Options

The camera settings and other values can be set in the options tab.

Update

Update the LCC7201 software to the most up-to-date version, if available.

Support

For technical support, it launches Microsoft Outlook (if installed) and address to techsupport@thorlabs.com directly.

About

Displays the detailed information about the LCC7201 software. Please have these details available when contacting the Thorlabs Technical Support.

Help

Opens the LCC7201 software help documentation.

Thorlabs Logo

Open the Thorlabs home page by clicking the logo.

5.2.2. Image Preview Window

The image preview window is the main window for the camera image preview. By default, the system provides a clear field of view of $\varnothing 20\text{mm}$.

5.2.3. Preview Setting

The preview setting contains the view setting, camera parameter setting and light source current adjustment.

View Setting

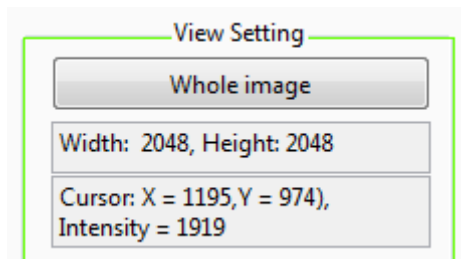

Figure 17 Preview Setting Area of LCC7201 GUI

Display the camera preview with Width and Height, Cursor Position and Intensity, and Binning mode.

The Region of Interest (ROI) can be selected by dragging a rectangular region in the image preview window. With ROI selected, the camera reads out only the ROI area and it can increase frame rate. In turn it can increase the measurement speed.

The Whole Image (Full Frame) button resets the Region of Interest to the entire camera sensor area.

Camera Setting

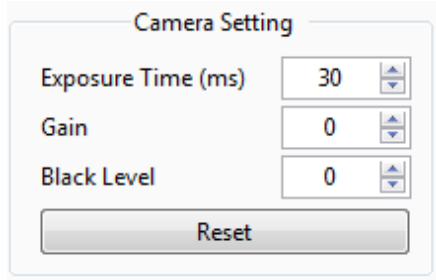

Figure 18 Camera Dynamic Setting Area of LCC7201 GUI

The camera settings provide access to camera controls including the exposure time, gain and black level.

Exposure Time

Set the exposure time for all frames to be acquired. The unit here is milliseconds.

Gain

The relative gain applied to the analog signal from the image sensor. The unit here is 0.036 dB per step.

Black Level

The average image signal from the camera in the absence of light. Increments of 0.25 ADU (Analog to Digital Unit) are used.

Reset

Reset the camera parameters to default.

Light Source Control

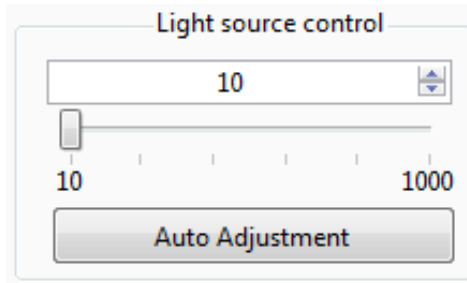

Figure 19 Light Source Control Area of LCC7201 GUI

Sets the current supplied to the LED to a value between the minimum and maximum .

The Auto Adjustment button automatically adjusts the LED brightness to provide to the most suitable intensity level. This level depends on the current sample under test, so place the sample in the sample stage and orient into the desired position before using Auto Adjustment.

Over-exposure detection is integrated in the software – the status will be shown in the status bar when the preview image is over-exposed. If this occurs, reduce the LED current, or use Auto Adjustment, before starting a measurement.

5.2.4. Status Bar

The status bar displays information about the system status including:

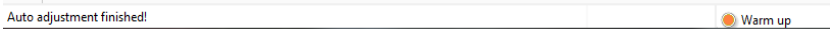

Figure 20 Status Bar of LCC7201 GUI

- Image Preview Information
- Measurement Information
- System Temperature Information
- Light Source Over Exposure Detection Status

5.2.5. Measurement Control

The LCC7201 contains two measurement modes with different measurement ranges.

Standard Mode

Higher measurement rate with a lower signal-to-noise ratio.

Low Noise Mode

Lower measurement rate with a higher signal-to-noise ratio.

The measurement rate depends on the camera exposure time. An exposure time of 30 ms is set as the default, which allows a measurement to be finished within 15 seconds in standard mode and 3 minutes in low noise mode.

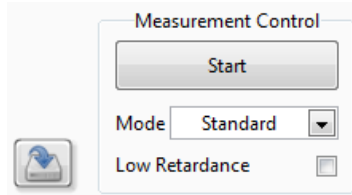

Figure 21 Measurement Control Area of LCC7201 GUI

Standard Retardance Range

The Standard Retardance provides a measurement accuracy of $< \pm 10$ nm for retardance and $< \pm 3^\circ$ for azimuths over the entire measurement range.

Low Retardance Range

The Low Retardance Range will improve the measurement accuracy of retardance to $< \pm 1$ nm in the retardance measurement range from 0 to 100 nm, as well as the measurement accuracy of azimuths to $< \pm 1^\circ$ over the entire azimuth measurement range.

A background needs to be collected before starting the measurement in Low Retardance Range.

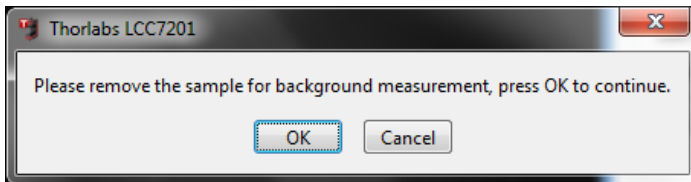

Figure 22 Background Collection Guide Window

Follow the instructions until the background collection is finished.

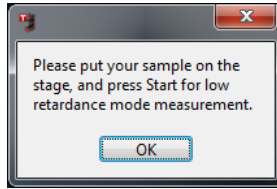



Figure 23 Background Collection Status Indication

The background must be re-collected if the camera and LED settings have been revised.

The screenshot button  saves the preview image file in PNG format.

5.2.6. Measurement Data Views

The three tabs below the Image Preview tab in the LCC7201 software provide three different views for the measurement results.

1D View

Displays the measurement results in 1D view. The 1D tab consists of two parts:

- Data in XY Graph
- Row/Column Data Selection

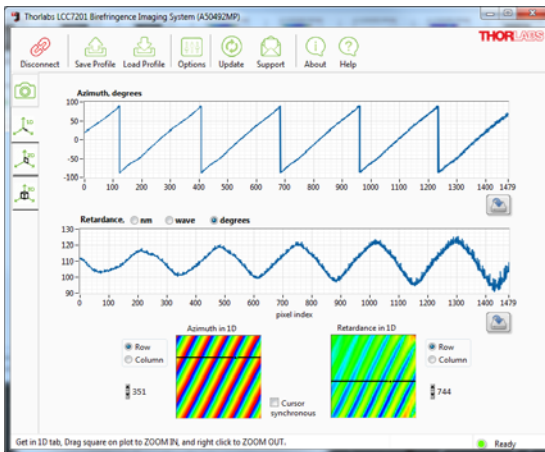

Figure 24 1D Data View of Measured Sample, Thorlabs DPP25-A

Row/Column Selection

Two intensity graphs will show the measured azimuth and retardance. The row or column of interest can be selected by dragging the row/column bar in the intensity graph. The selected data will be shown in the XY Graphs above the intensity graphs.

Select the row/column bar in the selection box:

Row
 Column

The cursor synchronous Cursor synchronous offers a synchronous move for the row/column bar in both two intensity graphs.

Data in XY Graph

The XY graphs show the selected row/column data of measured azimuth and retardance. Both the XY graphs can be zoomed in by mouse dragging. Right click on the graphs to return to the full measurement range.

The minimum and maximum values of X or Y axis can be user defined.

Click the button  to save the data in comma separated value (CSV) format.

2D View

2D view tab contains four sections:

- Measurement Data Display
- Display Mode Selection
- Data Unit and Data Analysis
- Save Data and Image

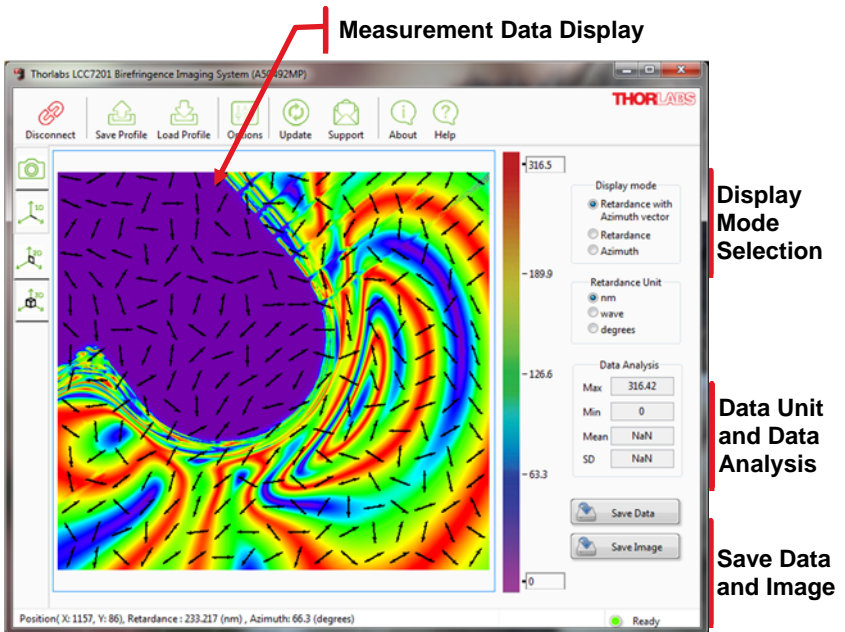

Figure 25 2D View Tab with Four Sections

Measurement Data Display

The measurement data is shown with an intensity graph. The color bar indicates the data range. The maximum and minimum values of the color bar are user defineable.

The display mode is selectable in the “Display Mode Selection” area.

Display Mode Selection

Displays the measurement results in 2D view with three display modes.

Retardance with Azimuth Vector

The intensity graph shows the measured sample’s retardance and the vector graph with arrows indicating the sample’s fast axis orientation (azimuth). See Figure 25.

Retardance Mode

The intensity graph shows only the measured sample’s retardance.

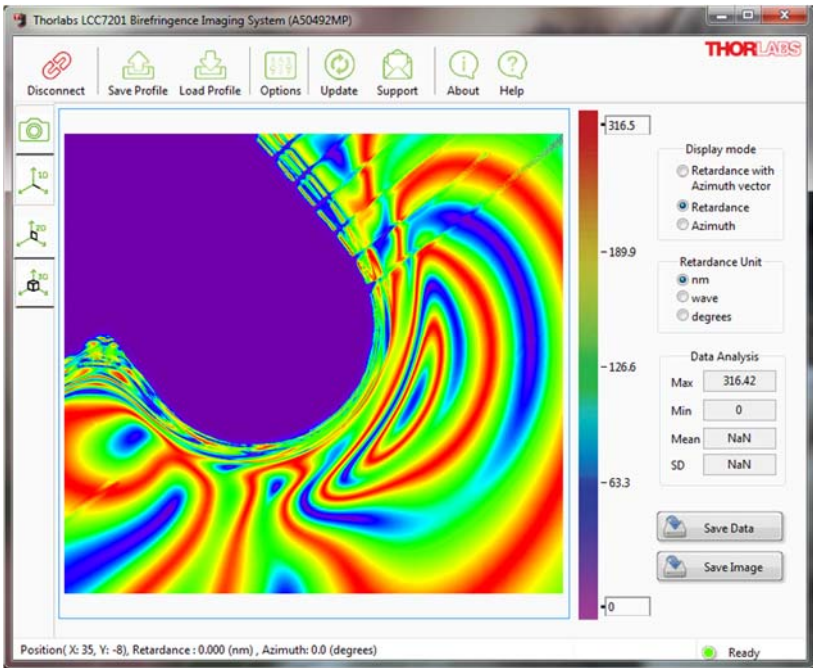

Figure 26 2D Data Display Mode of Retardance

Azimuth Mode

The intensity graph shows only the measured sample's azimuth with values indicated by the color bar.

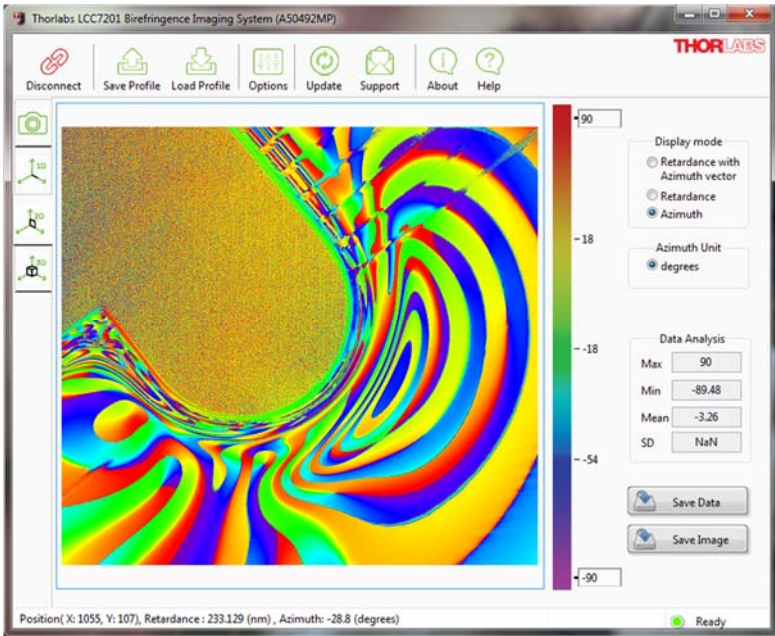

Figure 27 Data Display Mode of Azimuth

Data Unit and Data Analysis

Units of nm, waves, and degrees are selectable regarding the measured retardance. A simple data analysis section shows the maximum, minimum, mean and SD (standard deviation) values, which are based on the selected display mode.

Save Data and Image

Save the data into CSV or binary (BIN) file format, or save the image of "Measurement Data Display" area into PNG file format.

3D View

Displays the measured sample retardance or azimuth in a 3D graph with selectable data unit. The 3D graph can be dragged with the mouse for different viewing orientations.

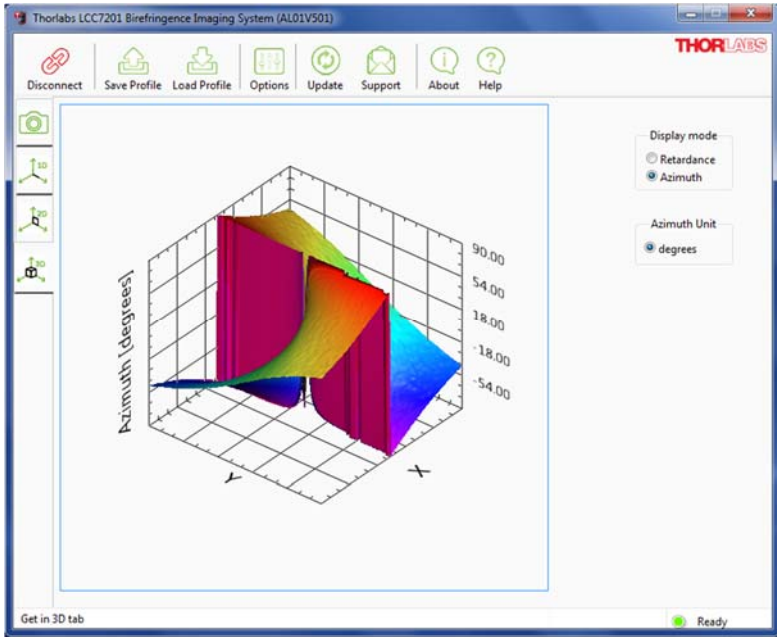

Figure 28 3D Data Display of a Sample, Item # WPV10-532

Chapter 6 Maintenance

6.1. Basic Care

Handle the complete system with care during the transportation and unpacking. Banging or dropping the system can damage the unit or lower the system performance. If the system is mishandled during the shipment, the optical components inside may become misaligned, which would lead to an accuracy decrease of the measurement performance. If this occurs, the complete system will need to be sent back for realignment and recalibration. Please contact Thorlabs technical support for more information.

- Do not store or operate in a damp, closed environment.
- Do not store or operate on surfaces that are susceptible to vibrations.
- Do not expose to direct sunlight.
- Do not use the solvents on or near the equipment.
- Mobile telephones, cellular phones or other radio transmitters should not be used with a range of 3 m of this unit since the electromagnetic field intensity may exceed the maximum allowable disturbance values, according to EN50082-1.
- Keep away from dust, dirt, and air-borne pollutants (including cigarette smoke). The system is not designed for outdoor use. Protect the equipment from rain, snow, and humidity.
- Do not expose to mechanical and thermal extremes. Protect the equipment from rapid variations in temperature.
- Handle all connectors with care. Do not use unnecessary force, as this may damage the connectors.
- Handle the mainframe with care. Mishandling may cause the body injury.
- Clean the protective window by using a soft, lint free cloth. Use of isopropyl alcohol is permitted; however, do not immerse in any liquid or solvent.
- Clean any accessible optical surfaces with an appropriate optics grade tissue or cloth.

6.2. Service



CAUTION



Except for the main fuse, which is accessible from the outside of the housing, LCC7201 has no user-serviceable parts. Service should only be performed by trained service personnel.

Only trained and approved Thorlabs' personnel should service the system. Please contact Thorlabs' Technical Support at techsupport@thorlabs.com and a member of our team will be happy to assist you.

Chapter 7 Specifications

Item #	LCC7201	
Light Source Wavelength	633 nm	
Measurement Range	Retardance	Standard Retardance Range: 0 to 316 nm Low Retardance Range: 0 to 100 nm
	Azimuth	$\pm 90^\circ$
Measurement Accuracy	Retardance	Standard Retardance Range: $< \pm 10$ nm Low Retardance Range: $< \pm 1$ nm
	Azimuth	Standard Retardance Range: $< \pm 3^\circ$ Low Retardance Range: $< \pm 1^\circ$
Measurement Rate	<15 sec (Based on Default Camera Settings)	
Field of View	$\varnothing 20$ mm	
Spatial Resolution	9.77 μ m	
Interface	USB 2.0 & GigE	
Imager Resolution	2048 x 2048 Pixels	
Sample Roughness	Optical Grade	
Dimensions	500.0 mm (D) x 360.0 mm (W) x 672.0 mm (H)	
Weight	26 kg (57.3 lbs)	
Operating Temperature	0 to 40 °C	
Storage Temperature	-15 to 65 °C	
Accessory	Laptop PC, Sample Holders, Resolution Target R2L2S1B	

7.1. Mechanical Drawings

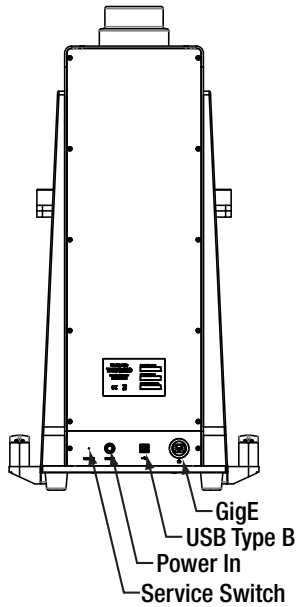
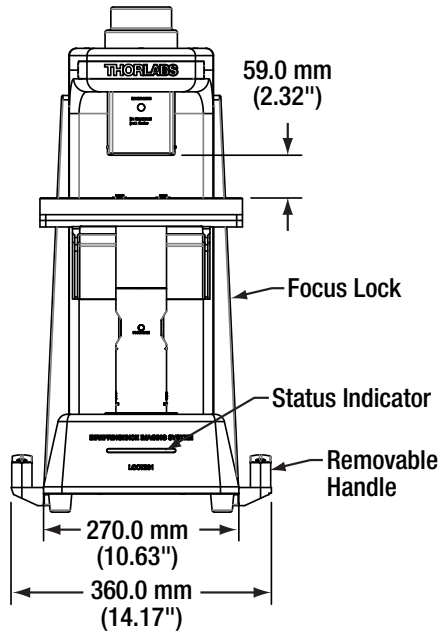

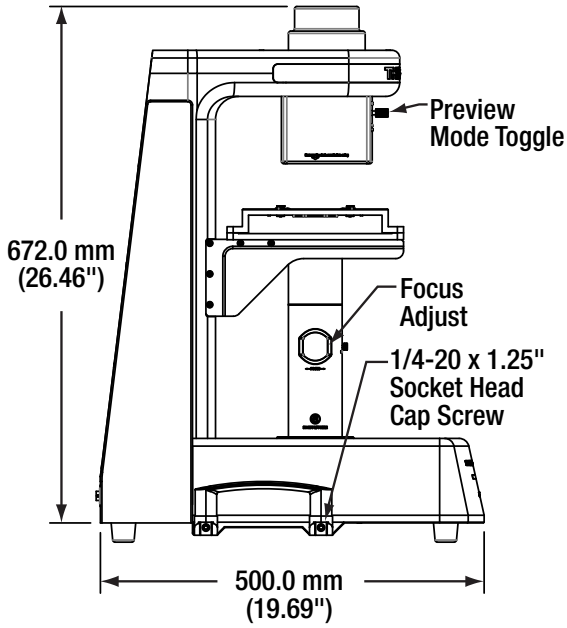

Chapter 8 Trouble Shooting

Symptom	Possible Cause	Solution
System does not Start	No power is supplied to the device	Connect the power supply
	Power switch is off	Switch on the power
	Power cord is broken	Change power cord
GUI does not Start	No USB cable is connected to the device	Connect the USB cable
	No LAN cable is connected to the device	Connect the LAN cable
	USB cable is broken	Change USB cable
	Network cable is broken	Change LAN cable
System does not Perform Measurement	Software halted	Restart PC
	Poor connection of USB cable	Check USB connection
	Poor connection of LAN cable	Check LAN cable connection
No Image	Light source is blocked	Remove dust cover
	Light source intensity is too low	Adjust LED current or camera settings

If problem cannot be identified, contact Thorlabs Technical Support.

Chapter 9 CE/FCC Certification

In accordance with European Council Directive 2014/30/EU, this product has been assessed against and found compliant with the following Applicable Standards:

EN 55011:2009/A1:2010(Class A)	EN 61326-1:2013
EN 61326-2-1:2013	EN 61326-2-2:2013
EN 61000-3-2:2014	EN 61000-4-2:2009
EN 61000-3-3:2013	EN 61000-4-3:2006+A1:2008+A2:2010
EN 61000-4-4:2012	
EN 61000-4-5:2014	
EN 61000-4-6:2014	
EN 61000-4-8:2010	
EN 61000-4-11:2004	

This device complies with Part 15 of the FCC Rules. Operation is subject to the following two conditions:

- (1) This device may not cause harmful interference, and
- (2) This device must accept any interference received, including interference that may cause undesired operation.