



BC141, BC142, BC142-5 & BC142-6 DC Control

Any trademarks used in this manual are the property of their respective owners.

Table of Contents

Chapter 1

Introduction

Introduction	1-1
Safety Notice	1-1
Receiving	1-2

Chapter 2

Installation

Mounting Instructions	2-1
Electrical Connections	2-1
AC Line Fusing	2-1
AC Line Connection	2-2
Ground Connection	2-2
Permanent Magnet (PM) Motor Connection	2-3
Motor Field Connection (Shunt Wound Motors Only)	2-3
Full Voltage Field	2-3
Plug-In Horsepower Resistor® & Armature Fuse Kit*	2-3
Armature Fuse*	2-3
Remote Main Speed Potentiometer Connection	2-4
Voltage Following Connection	2-4
Enable Circuit Connection	2-5
Inhibit Circuit Connection	2-6
DC Tachometer Connection	2-6
Armature Switching and Dynamic Braking	2-8
Startup & Adjustments	2-8
Trimpot Adjustments	2-9
Operation	2-11
Troubleshooting	2-11
Optional Accessories	2-12

Chapter 1

Introduction

Introduction

Thank you for purchasing the BC141, BC142, BC142-5 or BC142-6 full-wave variable speed DC motor control. The control, with Surface Mount (SMT) construction, offers the user the ultimate in reliability and performance at an affordable price. The controls contain a unique patented super-fast Direct-Fed™ current limit circuit that protects the SCR power bridge against direct shorts¹. The reliability of the control is further enhanced with the use of high-surge, 25 Amp SCRs, and AC line and armature fusing^{2,3}. The control is designed with exclusive Plug-In Horsepower Resistor®³, which eliminates the need for recalibrating IR Comp and Current Limit when the control is used on various horsepower motors. In addition, the rating of the control can be extended to 1.5 HP for controls with 90 Volt DC output and 3 HP for controls with 180 Volt DC output, by the use of an Auxiliary Heat Sink⁴. Catalog Nos. BC142, BC142-5 and BC142-6 also allow operation of 90 Volt DC motors when used on 208/230 Volt AC line input⁵.

The versatility of the control is confirmed by its extensive list of standard features, such as: selectable armature or tach feedback and adjustment trim pots for minimum speed, maximum speed, current limit, IR compensation, and linear acceleration and deceleration. The control includes Auto-Inhibit®, which eliminates surging during rapid AC line switching; pulse transformer triggering, which provides cogless operation at low speed; and superior noise rejection circuitry, which eliminates false starts and blown SCRs. Enable (normally closed) and Inhibit (normally open) functions provide electronic switching of control output.

The output voltage of the control is a linear function of the Main Speed Potentiometer setting. In addition, the control can be used in a voltage following mode by supplying an isolated analog input signal to Terminals P2 (+) and P1 (-). The control is compact in size (only 4.30 X 3.64 X 1.25) and easily replaces all competitive speed controls. The control is supplied with a factory installed 25 Amp AC line fuse, a 5 kΩ Main Speed Potentiometer and QD terminals. All models are UL Listed (USA and Canada) and CE Approved.

SAFETY NOTICE

A Warning statement indicates a potentially hazardous situation which, if not avoided, could result in injury or death.

A Caution statement indicates a potentially hazardous situation which, if not avoided, could result in damage to property.

A Note indicates additional information that is not critical to the installation or operation.

WARNING: This equipment may contain voltages as high as 1000 volts! Electrical shock can cause serious or fatal injury. Only qualified personnel should attempt the start-up procedure or troubleshoot this equipment.

WARNING: Be sure the system is properly grounded before applying power. Do not apply AC power before you ensure that all grounding instructions have been followed. Electrical shock can cause serious or fatal injury.

WARNING: Electrical shock can cause serious or fatal injury. Be sure that all power is disconnected and there is no voltage present from this equipment or equipment to which it is or will be connected. Electrical shock can cause serious or fatal injury. Only qualified personnel should attempt the installation and start-up procedures.

WARNING: Electrical shock can cause serious or fatal injury. Verify there is no voltage phase-to-phase or phase-to-neutral at the motor leads before connecting motor to this control. Motor may have high voltage present even when disconnected from this control.

WARNING: Do not use motor overload relays with an automatic reset feature. These are dangerous since the process may injure someone if a sudden or unexpected automatic restart occurs. If manual reset relays are not available, disable the automatic restart feature using external control wiring.

WARNING: This unit has an automatic restart feature that will start the motor whenever input power is applied and a RUN (FWD or REV) command is issued. If an automatic restart of the motor could cause injury to personnel, the automatic restart feature should be disabled.

WARNING: Using a jumper to eliminate the start/stop function will cause the motor to run at the Main Speed Potentiometer setting when the AC line is applied.

SAFETY NOTICE Continued

- WARNING:** If possible, do not adjust trim pots with the main power applied. Electrical shock can cause serious or fatal injury. If adjustments are made with the main power applied, an insulated adjustment tool must be used to prevent shock hazard and safety glasses must be worn.
- WARNING:** Do not use this drive in an explosive environment. An explosion can cause serious or fatal injury. This drive is not explosion proof.
- WARNING:** When the Enable jumper is installed, the drive and motor will start and run when AC power is applied, when power is restored after a momentary power loss, or after an overload or TCL fault is reset. The user must ensure that automatic start up of the driven equipment will not cause injury to operating personnel or damage to the driven equipment. The user is responsible for providing suitable audible or visual alarms or other devices to indicate that the drive may start at any moment. Failure to observe this warning could result in severe bodily injury or loss of life.
- WARNING:** Do not use start/stop, inhibit or enable functions as a safety disconnect. Use only an AC line disconnect for that purpose. Failure to observe this warning could result in severe bodily injury or loss of life.
- Caution:** Disconnect motor leads (A1 and A2) from control before you perform a Dielectric Withstand test on the motor. Failure to disconnect motor from the control will result in extensive damage to the control. The control is tested at the factory for high voltage / leakage resistance as part of Underwriter Laboratory requirements.
- Caution:** Do not connect AC power to the Motor terminals A1 and A2. Connecting AC power to these terminals may damage the control.
- Caution:** Baldor recommends not to use Grounded Leg Delta transformer power leads that may create ground loops. Instead, we recommend using a four wire Wye.
- Caution:** Suitable for use on a circuit capable of delivering not more than 5,000 RMS symmetrical short circuit amperes listed here at rated voltage.
- Caution:** Adjusting the current limit above 150% of the motor nameplate rating can cause overheating and demagnetization of the PM motor.
- Caution:** Do not leave the motor in a locked rotor condition for more than a few seconds since motor damage may occur.
- Caution:** Shunt wound motors may be damaged if field windings remain energized for an extended period of time without armature rotation.

Receiving

Each control is thoroughly tested at the factory and carefully packaged for shipment. When you receive your control, there are several things you should do immediately.

1. Observe the condition of the shipping container and report any damage immediately to the commercial carrier that delivered your control.
2. Verify that the part number you received is the same as the part number listed on your purchase order.
3. Do not unpack until ready for use.

Table 1-1 Electrical Ratings

Catalog Number	AC Line VAC (±15%, 50/60Hz)	Motor VDC	Rating without Auxiliary Heat Sink			Rating with Auxiliary Heat Sink			Field VDC (1.13 Amps Max)
			Max AC Line Current Amps	Max DC Load Current Amps	Max Power HP (kW)	Max AC Line Current Amps	Max DC Load Current Amps	Max Power HP (kW)	
BC141	115	0-90	12	8	.75 (.6)	24	16	1.5 (1.1)	50, 100
BC142	230	0-180	12	8	1.5 (1.1)	24	16	3 (2.3)	100, 200
		0-90*	12	8	.75 (.6)	24	16	1.5 (1.1)	100
BC142-5	115	0-90	9	6	.75 (.6)	18	12	1.5 (1.1)	50, 100
		0-180	9	6	1.5 (1.1)	18	12	3 (2.3)	100, 200
		0-90*	9	6	.75 (.6)	18	12	1.5 (1.1)	100
BC142-6	115	0-90	12	8	.75 (.6)	24	16	1.5 (1.1)	50, 100
		0-180	12	8	1.5 (1.1)	24	16	3 (2.3)	100, 200
		0-90*	12	8	.75 (.6)	24	16	1.5 (1.1)	100

Table 1-2 General Performance Specifications

Description	Specification	Factory Setting
Speed Range (Ratio)	50:1	—
Armature Feedback Load Regulation (0 - Full Load, 50:1 Speed Range) (% Base Speed)	1	—
Tachometer Feedback Load Regulation (0 - Full Load, 50:1 Speed Range) (% Set Speed)	1	—
Line Voltage Regulation (at Full Load, ± 10% Line Variation) (% Speed)	0.5	—
Control Linearity (% Speed vs. Dial Rotation)	2	—
Acceleration (ACCEL) Trimpot Range (Seconds)	0.2 – 10	2
Deceleration (DECEL) Trimpot Range (Seconds)	0.2 – 10	2
Maximum Speed (MAX) Trimpot Range (% Base Speed)	50 – 110	100
Minimum Speed (MIN) Trimpot Range (% Base Speed)	0 – 30	0
Current Limit (CL) Trimpot Range (% Full Load)	0 – 200	150
IR Compensation (IR) Trimpot Range (at Specified Full Load @ 90, 180 Volts DC Output) (Volts DC)	0 – 24, 48	3, 6
Maximum Operating Ambient Temperature at Full Load - °C / °F	40 / 104	—

WARNING: Do not use this drive in an explosive environment. An explosion can cause serious or fatal injury. This drive is not explosion proof.

MOUNTING INSTRUCTIONS

It is recommended that the control be mounted on a flat surface with adequate ventilation. Leave enough room to allow for AC line, motor connection, and other wiring that is required. Care should be taken to avoid extreme hazardous locations where physical damage can occur. When mounting the control in an enclosure, the enclosure should be large enough to allow for proper heat dissipation so that the ambient temperature does not exceed 40°C (104°F). If the optional Auxiliary Heat Sink is used, mount the control in such a manner that there is unrestricted air flow through the heat sink cooling fins. See Figure 2-1.

Figure 2-1 Mechanical Specifications (Inches/mm)

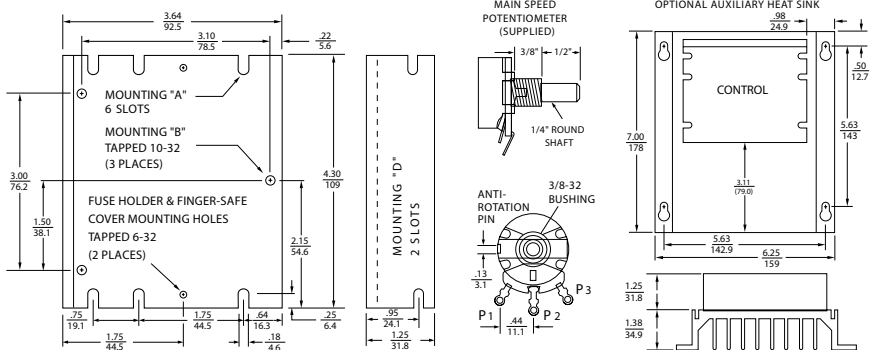

Electrical Connections

Important Application Note: To avoid erratic operation, do not bundle the AC line and motor wires with signal or control wiring. Also, do not bundle motor wires from multiple controls in the same conduit. Use shielded cables on all signal wiring over 12 (30 cm). The shield should be earth grounded on the control side only. Wire the control in accordance with the National Electrical Code requirements and other local codes that may apply.

Table 2-2 Minimum Supply Wire Size Requirements

Max Motor Current (ADC)	90 - 130 VDC Motors (Max HP)	180 Volt DC Motors (Max HP)	Min Wire Size (Cu)			
			Maximum 50 Ft.		Maximum 100 Ft.	
			AWG	mm ²	AWG	mm ²
6	0.5	1	16	1.3	14	2.1
12	1	2	14	2.1	12*	3.3*
16	1.5	3	12*	3.3*	12*	3.3*

AC Line Fusing

A 25 Amp AC line fuse is factory installed in the AC line fuse holder. It is recommended that a 12 Amp AC line fuse be installed for motors rated 7.5 Amps DC or less. Fuses should be normal blow ceramic 3AG, MDA, or equivalent. For USA 230 Volt AC lines, separate branch circuit protection for each line must be used. The optional Barrier Terminal Board (Catalog No. BC147) contains prewired AC line and armature fuse holders.

The AC Line Fuse protects the control against catastrophic failure. If the AC Line Fuse blows, the control is miswired, the motor is shorted or grounded, or the control is defective.
 Fuse holders and fuses not supplied with BC142-5.

Note: Fuse each AC line conductor that is not at ground potential.

Figure 2-2 Control Layout & General Connection Diagram (Catalog No. BC142-6 Shown)

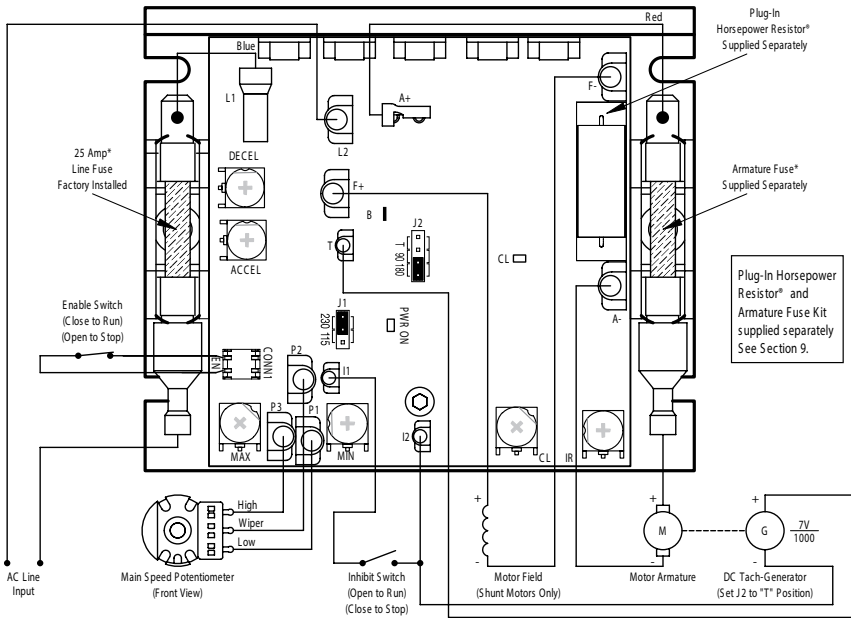

* Fuse holders and fuses not supplied with BC142-5.

AC Line Connection

WARNING: Electrical shock can cause serious or fatal injury. Be sure that all power is disconnected and there is no voltage present from this equipment or equipment to which it is or will be connected. Electrical shock can cause serious or fatal injury. Only qualified personnel should attempt the installation and start-up procedures.

The control can be turned “on” and “off” using the AC line disconnect. Auto-Inhibit® circuitry automatically resets critical components each time the AC line is interrupted. This, along with Acceleration Start and CL, provides a smooth start each time the AC line is applied.

Connect the AC line to Terminals L1 (Line Fuse)* and L2, Figure 2-2. For 115VAC connect neutral to L2.

Catalog No. BC141 operates on 115 Volt AC line input only.

Catalog No. BC142 operates on 208/230 Volt AC line input only.

Catalog BC142-5 and BC142-6 operates on 115 Volt AC line input when Jumper J1 is set to the 115 position and operates on 208/230 Volt AC line input when Jumper J1 is set to the 230 position (factory setting).

* Fuse holders and fuses not supplied with BC142-5.

Note: When using a step-down transformer (460 Volts AC to 230 Volts AC), be sure the output current rating of the transformer is at least 3 times the current rating of the motor. Do not switch the primary side of the transformer to disconnect power or catastrophic failure can result. Always disconnect the control from the secondary side of the transformer.

Ground Connection

Connect the ground wire (earth) to the control chassis.

Permanent Magnet (PM) Motor Connection

Connect the motor armature positive lead (+) to Terminal A+ (Armature Fuse*) and the negative lead (-) to Terminal A-. On Catalog Nos. BC142, BC142-5 and BC142-6, be sure Jumper J2 is set to the corresponding motor voltage. Be sure the correct Plug-In Horsepower Resistor® is installed.

* Fuse holders and fuses not supplied with BC142-5.

Motor Field Connection (Shunt Wound Motors Only) see Figure 2-2

CAUTION! Do not connect motor armature leads to Terminals F+ and F-. Do not use Terminals F+ and F- for any purpose other than to power the field of a shunt wound motor. Shunt wound motors may be damaged if the field remains energized without armature rotation for an extended period of time.

Full Voltage Field

Connect the field positive (+) lead to Terminal F+ and the negative lead (-) to Terminal F-.

Half Voltage Field

For 50 Volt DC with 100 Volt rated armature, use Terminal L1 and F+.

Table 2-3 Field Connection (Shunt Wound Motors Only)

Catalog No.	Input Voltage (VAC)	Armature Voltage (VDC)	Field Voltage (VDC)	Terminal Connections
BC141	115	0 -90	100	F+, F-
			50	F+, L1
BC142	208 / 230	0 -180	200	F+, F-
		0 -90*	100	F+, L1
BC142-5	115	0 -90	100	F+, F-
			50	F+, L1
			200	F+, F-
BC142-6	208 / 230	0 -90*	100	F+, L1

*Step-down operation.

PLUG-IN HORSEPOWER RESISTOR® & ARMATURE FUSE KIT*

The Plug-In Horsepower Resistor® and Armature Fuse are supplied as a prepackaged kit. Choose the appropriate Plug-In Horsepower Resistor® and Armature Fuse based on motor horsepower and voltage, see Table 2-4.

The Plug-In Horsepower Resistor® (supplied separately) must be installed to match the control to the motor horsepower and voltage.

Install the Plug-In Horsepower Resistor® see Figure 2-2.

Notes:

1. The Plug-In Horsepower Resistor® is used to calibrate the IR Compensation and Current Limit based on motor horsepower and voltage. The Plug-In Horsepower Resistor® eliminates the need to recalibrate IR Compensation and Current Limit in most applications.
2. Be sure the Plug-In Horsepower Resistor® is inserted completely into the mating sockets.

8.2 Armature Fuse*

It is recommended that an Armature Fuse (supplied separately) be installed in the armature fuse holder. Select the correct fuse. Fuses should be normal blow ceramic 3AG, MDA, or equivalent. The optional Barrier Terminal Board (Catalog No. BC147) contains prewired AC line and armature fuse holders. The Armature Fuse provides overload protection for the motor and control.

The Armature Fuse rating can be calculated by multiplying maximum DC Motor Current X 1.7.

* Fuse holders and fuses not supplied with BC142-5.

Table 2-4 Plug-In Horsepower Resistor® & Armature Fuse Kit Selection

90 -130 VDC Motors (HP)	180 VDC Motors (HP)	Approximate Motor Current (ADC)	Plug-In HP Resistor and Armature Fuse Kit Cat. No.	Plug-In HP Resistor Value (Ω)	Armature Fuse Rating (Amps)
1/100	1/50	0.2	BR1000	1	0.5
1/50	1/25	0.3	BR0510	0.51	0.5
1/30	1/15	0.33	BR0350	0.35	0.5
1/20	1/10	0.5	BR0250	0.25	0.75
1/15	1/8	0.8	BR0251	0.25	1
1/12	1/6	0.85	BR0180	0.18	1.25
1/8	1/4	1.3	BR0100	0.1	2
1/6	1/3	2	BR0101	0.1	2.5
1/4	1/2	2.5	BR0050	0.05	4
1/3	3/4	3.3	BR0035	0.035	5
1/2	1	5	BR0025	0.025	8
3/4	1-1/2	7.5	BR0015	0.015	12
1*	2*	10	BR0010	0.01	15
1-1/2*	3*	15	BR0006	0.006	25

* Indicates an Auxiliary Heat Sink (Catalog No. BC143, or equivalent) must be used.

Remote Main Speed Potentiometer Connection

The control is supplied with a Main Speed Potentiometer to control motor speed. Connect the low side of the potentiometer to Terminal P1. Connect the wiper of the potentiometer to Terminal P2. Connect the high side of the potentiometer to Terminal P3.

Figure 2-3 Remote Main Speed Potentiometer Connection

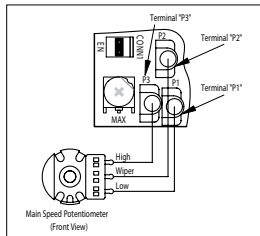

Voltage Following Connection

An isolated 0 - 9 Volt DC analog signal input can be used to control motor speed in lieu of the Main Speed Potentiometer. The control output voltage will linearly follow the analog signal input. The signal input must be isolated from the AC line. Connect the signal input positive lead (+) to Terminal P2 and the negative lead (-) to Terminal P1. The source impedance of the signal input should be 10 kΩ or less. The MAX Trimpot is not operational in voltage following mode. Set the MIN Trimpot, on the control, to zero output (full counterclockwise rotation) and use auxiliary trimpots, if necessary, to scale and/or limit the input voltage.

Figure 2-4 Voltage Following Connection

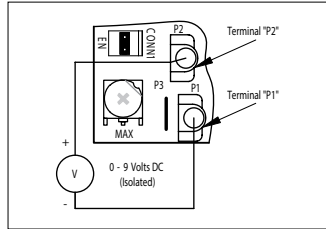

Notes:

1. If an isolated signal input is not available, or if using a 4 - 20 mA DC signal input, install the optional plug-on Catalog No. BC152 Signal Isolator. This will also allow direct connections to process controllers and microprocessors.
2. If multiple follower motors are to be controlled from a single leader motor or a single Main Speed Potentiometer, install the optional Catalog No. BC145 Signal Isolator.
3. Terminal F- may be used in lieu of Terminal P1.

Enable Circuit Connection

Opening the Enable Circuit will not stop the drive if the Min Trimpot and/or the Main Input Speed Signal is not at Zero Setting.

The Enable Circuit is never to be used as a Safety Disconnect since it is not fail-safe.

The control can be started and stopped with an Enable Circuit (close to run), as follows.

Enable Switch or Contact Wired to the Enable Connector

Using the wired mating connector that is supplied with the control, connect the switch or contact to the Enable connector (CONN1). When the switch or contact is closed, the motor will accelerate to the Main Speed Potentiometer setting. When the switch or contact is opened, the motor will decelerate to Stop. An open collector (PNP) can be used in lieu of a switch or contact.

Figure 2-5 Enable Switch Or Contact Wired To The Enable Connector

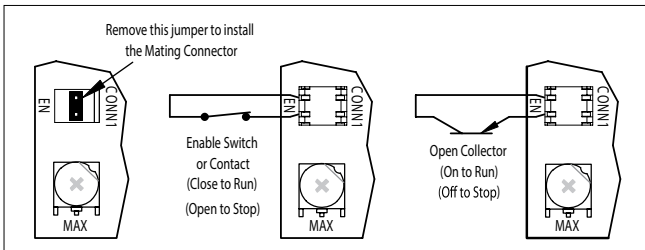

Notes:

1. To use the Enable Circuit, remove the jumper that is factory installed on CONN1.
2. The deceleration time can only be made longer than the normal coasting time of the load.

Enable Switch or Contact Wired to the Main Speed Potentiometer

Connect the switch or contact in series with the Main Speed Potentiometer high side and Terminal P3 on the control. Be sure the jumper is installed on the Enable Connector (CONN1). When the switch or contact is closed, the motor will accelerate to the Main Speed Potentiometer setting. When the switch or contact is opened, the motor will decelerate to the MIN Trimpot setting (factory set to 0 Volts DC). If the MIN Trimpot is set to other than 0 Volts DC, the motor will run at the MIN speed setting when the switch or contact is opened. An open collector (PNP) can be connected in lieu of a switch or contact.

Notes:

1. The deceleration time can only be made longer than the normal coasting time of the load.
2. If the BC152, Signal Isolator option board is installed onto the BC141, or BC142 control, the ENABLE circuit will not function as described. If an ENABLE feature is required for the application, connect a N.O. (normally open), contact or switch between the speed adjust potentiometer wiper lead, or voltage following input signal, and the SIG terminal of TB1. When the contact or switch is closed, the motor will accelerate to set speed. When the contact or switch is opened, the motor will decelerate to zero speed at a rate set with the DECEL trimpot.

Figure 2-6 Enable Switch Or Contact Wired To The Main Speed Potentiometer

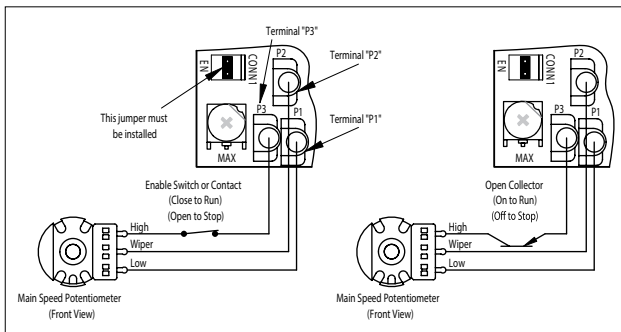

Inhibit Circuit Connection

The control can be stopped and started with an Inhibit Circuit (close to stop). Wire the switch or contact to Terminals I1 and I2. When the switch or contact is closed, the motor will coast to stop. When the switch or contact is opened, the motor will accelerate to the Main Speed Potentiometer setting. An open collector (NPN) can be connected in lieu of a switch or contact.

The Inhibit Circuit is never to be used as a Safety Disconnect since it is not fail-safe.

Figure 2-7 Inhibit Switch Or Contact Wired To The Inhibit Terminals

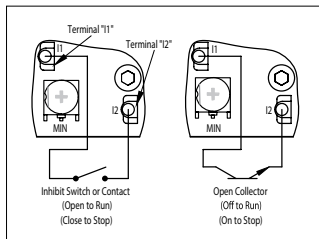

DC Tachometer Connection

A DC tachometer can be used for load regulation of 1% of the set speed.

Jumper J2 must be set to the T position for tachometer operation.

Notes

1. The tachometer input circuit is designed for a 7 Volt or 50 Volt per 1000 RPM DC tachometer used with an 1800 RPM motor.
2. Initially set the IR Comp Trimpot fully counterclockwise. Once the tachometer is connected, the IR Comp Trimpot may be increased for additional speed stabilization.

Seven (7) Volt per 1000 RPM Tachometer

Connect the tachometer positive lead (+) to Terminal T and the negative lead (-) to Terminal I2.

Figure 2-8 DC Tachometer Connection (7 Volts Per 1000 RPM)

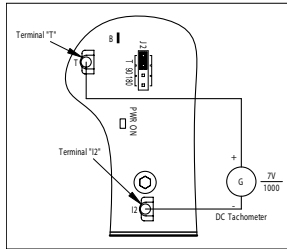

Fifty (50) Volt per 1000 RPM Tachometer

Connect the tachometer positive lead (+) to Terminal B and the negative lead (-) to Terminal I2.

Figure 2-9 DC Tachometer Connection (50 Volts Per 1000 RPM)

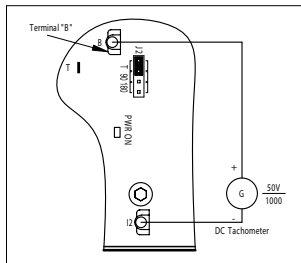

Other Tachometer Voltages

The tachometer input circuit is designed for a 7 Volt or 50 Volt per 1000 RPM DC tachometer used with an 1800 RPM motor. For a tachometer other than 7 Volts or 50 Volts per 1000 RPM, or for a motor other than 1800 RPM, an external 1/2 Watt resistor (RT) must be installed. Install RT in series with the tachometer.

Connect one end of RT to Terminal T, connect the other end of RT to the tachometer positive lead (+), and connect the negative lead (-) of the tachometer to Terminal I2.

The value of RT Ω can be calculated using the following formula: $RT = (1.3 \times VT \times S) - 16000 \Omega$

VT is the tachometer voltage (in Volts per 1000 RPM) and S is the base speed of the motor (in RPM).

Example: If a 20 Volt per 1000 RPM tachometer is to be used with a 3600 RPM motor:

$$RT = (1.3 \times 20 \times 3600) - 16000 = 77600 \Omega$$

Choose the closest 1/2 Watt resistor value, which is 75000 Ω (75 k Ω).

Figure 2-10 Other DC Tachometer Connection

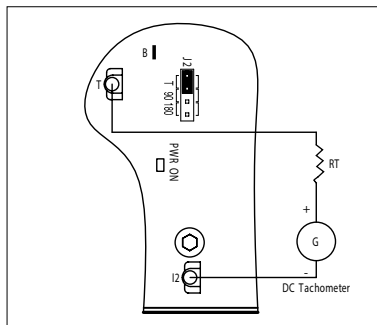

Armature Switching and Dynamic Braking

If the armature is to be disconnected and reconnected with the AC power applied, connect a relay (or contactor) and a brake resistor (RB) in the armature circuit. The Inhibit Circuit must be simultaneously activated when braking. Wire a double pole double throw (DPDT) mechanically ganged switch to the Inhibit Terminals and the relay (or contactor) coil.

When the switch is in the “Brake” position, the relay is deenergized and allows the motor voltage, through N.C. contact, to be dissipated through RB and dynamically brake the motor. Simultaneously, the inhibit is activated and the control output is electronically “extinguished”, which eliminates arcing.

Figure 2-11 Typical Dynamic Braking Circuit Connection

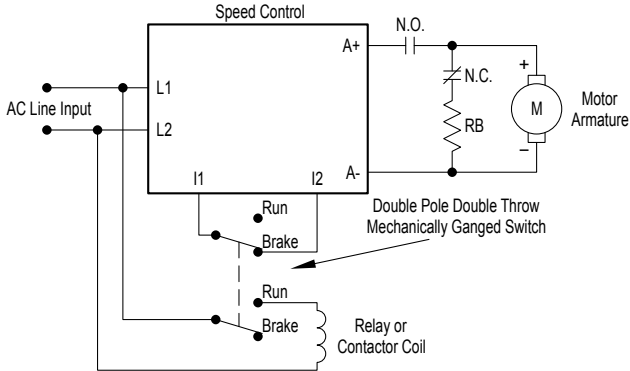

When the switch is in the “Run” position, the N.C. contact opens, the N.O. contact closes, the Inhibit is deactivated, and the motor begins to accelerate (according to the setting of the ACCEL Trimpot) to the Main Speed Potentiometer setting.

Startup & Adjustments

The control has selectable jumpers which must be set before it can be used.

J1, AC Line Input Voltage Selection (Catalog No. BC142-5 and BC142-6 only)

Jumper J1 is factory set to the 230 position for 208/230 Volt AC line input. For 115 Volt AC line input, set Jumper J1 to the 115 position, Figure 2-2.

Note: When Jumper J1 is set to the 115 position, Jumper J2 must be set to the 90 position (or the T position if using a tachometer).

J2, Motor Voltage and DC Tachometer Selection

Jumper J2 is factory set to the “90” position on Catalog No. BC141, for 90 Volt DC motors, and set to the “180” position, on Catalog Nos. BC142, BC142-5 and BC142-6, for 180 Volt DC motors. To set Catalog No. BC142, BC142-5 and BC142-6 for step-down operation (208/230 Volts AC line input and 90 Volt DC output), set Jumper J2 to the “90” position). To set the control for tachometer connection, set Jumper J2 to the “T” position (all models). See Figure 2-11.

Notes:

1. Catalog No. BC141, the “180” position is not available on Jumper J2.
2. Catalog No. BC142-5 and BC142-6, do not set the output voltage to 180 Volts DC when the AC line input is set to 115 Volts.

Figure 2-11 Motor Voltage & DC Tachometer Selection (Jumper J2)

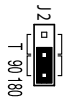
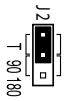
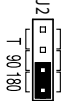
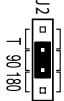
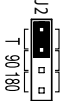
Catalog NoBC141		Catalog Nos. BC142, BC142-5 and BC142-6		
J2 Set for 90 Volt Motor (Factory Setting)	J2 Set for Tachometer	J2 Set for 180 Volt Motor (Factory Setting)	J2 Set for 90 Volt Motor (Step-Down)	J2 Set for Tachometer
				

Before power is applied,

1. Verify the Line voltage is correct for your control and is correctly connected.
2. Verify the Voltage Select Switch is correctly set.
3. Verify the correct line and armature fuses are installed and connected.
4. Verify the correct Plug-In Horsepower Resistor® is installed.
5. Verify the speed adjust potentiometer is set fully counterclockwise.
6. Verify the Forward-Brake-Reverse switch is correctly set (if installed).
7. Apply AC power.
8. Observe the Power ON LED indicator is illuminated. If not on, refer to troubleshooting.
9. Verify correct direction of motor rotation.
Start the control. The motor shaft should begin to rotate as the potentiometer knob is turned clockwise, or the analog speed reference signal is increased.
Verify the motor shaft is rotating in the desired 'forward' direction.
If the direction of rotation is incorrect, stop the control and disconnect AC power.
Switch the motor lead connections at the A+ and A- terminals.
If a tachometer is connected, the leads may also need to be switched for correct signal polarity.
If the CL LED is on, refer to troubleshooting.

WARNING: If possible, do not adjust trim pots with the main power applied. Electrical shock can cause serious or fatal injury. If adjustments are made with the main power applied, an insulated adjustment tool must be used to prevent shock hazard and safety glasses must be worn.

TRIMPOT ADJUSTMENTS

The control contains trimpots which have been factory set for most applications. Some applications may require readjustment of the trimpots in order to tailor the control for a specific requirement.

Acceleration Trimpot (ACCEL)

The ACCEL Trimpot is provided to allow for a smooth start over an adjustable time period each time the AC power is applied or the Main Speed Potentiometer is adjusted to a higher speed. The ACCEL Trimpot has been factory set to 2 seconds, which is the amount of time it will take for the motor to accelerate from zero speed to full speed. To increase the acceleration time, rotate the ACCEL Trimpot clockwise. To decrease the acceleration time, rotate the ACCEL Trimpot counterclockwise.

Deceleration Trimpot (DECEL)

The DECEL Trimpot controls the amount of ramp-down time when the Main Speed Potentiometer is adjusted to a lower speed. The DECEL Trimpot has been factory set to 2 seconds, which is the amount of time it will take for the motor to decelerate from full speed to zero speed. To increase the deceleration time, rotate the DECEL Trimpot clockwise. To decrease the deceleration time, rotate the DECEL Trimpot counterclockwise.

Note: The deceleration time cannot be less than the natural coast time of the motor and actual load.

Minimum Speed Trimpot (MIN)

The MIN Trimpot sets the minimum speed of the motor when the Main Speed Potentiometer is set fully counterclockwise. The MIN Trimpot is factory set to 0 % of base motor speed. To increase the minimum speed, rotate the MIN Trimpot clockwise. To decrease the minimum speed, rotate the MIN Trimpot counterclockwise.

Note: Readjusting the MIN Trimpot will affect the maximum speed setting. Therefore, it is necessary to readjust the MAX Trimpot if readjusting the MIN Trimpot. It may be necessary to repeat these adjustments until both the minimum and maximum speeds are set to the desired levels.

Maximum Speed Trimpot (MAX)

The MAX Trimpot sets the maximum speed of the motor when the Main Speed Potentiometer is set fully clockwise. The MAX Trimpot is factory set to 100 % of base motor speed. To increase the maximum speed, rotate the MAX Trimpot clockwise. To decrease the maximum speed, rotate the MAX Trimpot counterclockwise.

Do not set the maximum speed above the rated motor RPM since unstable motor operation may occur.

Current Limit Trimpot (CL)

The CL Trimpot sets the current limit (overload), which limits the maximum current (torque) to the motor. The CL also limits the AC line inrush current to a safe level during startup. The CL Trimpot is factory set to 1.5 times the full load rating of the motor. To increase the current limit, rotate the CL Trimpot clockwise. To decrease the current limit, rotate the CL Trimpot counterclockwise. Some applications require a lower torque limiting value so as not to damage the process material or the drive train.

Note: The correct value Plug-In Horsepower Resistor® must be installed for the CL to operate properly. Calibration of the CL Trimpot is normally not required when the proper Plug-In Horsepower Resistor® is installed.

Caution: Adjusting the CL above 150% of motor rating can cause overheating and demagnetization of some PM motors. Consult motor manufacturer.

To Recalibrate the CL Trimpot:

1. Disconnect the AC power and wire a DC ammeter in series with either motor armature lead.

Note: If only an AC ammeter is available, wire it in series with either AC line input lead.

2. Set the Main Speed Potentiometer to approximately 30 - 50 % clockwise position.
3. Set the CL Trimpot fully counterclockwise.
4. Load the motor shaft in accordance with application requirements.
5. Apply power and the CL LED will illuminate red. Rotate the CL Trimpot clockwise until the desired current reading is observed on the ammeter. Factory Current Limit setting is 1.5 times the full load rating of the motor (with a DC ammeter wired in series with the motor armature). If using an AC ammeter wired in the AC line input, the factory Current Limit setting will read 0.75 times the full load rating of the motor.

Note: On cyclical loads, it may be normal for the CL LED to momentarily flash.

IR Compensation Trimpot (IR)

The IR Trimpot sets the amount of compensating voltage required to keep the motor speed constant under changing loads. If the load does not vary substantially, the IR Trimpot may be set to a minimum level (approximately 1/4 of full clockwise rotation). The IR Trimpot is factory set to provide 3 Volts of compensation for controls with 90 Volt DC output and 6 Volts of compensation for controls with 180 VDC output. To increase the amount of compensating voltage, rotate the IR Trimpot clockwise. To decrease the amount of compensating voltage, rotate the IR Trimpot counterclockwise.

Notes:

1. The correct value Plug-In Horsepower Resistor® must be installed for the IR Compensation to operate properly. Calibration of the IR Trimpot is normally not required when the proper Plug-In Horsepower Resistor® is installed.
2. Excessive IR Compensation will cause the motor to become unstable, which causes cogging.
3. For tachometer feedback applications, set the IR Trimpot fully counterclockwise.

To Recalibrate the IR Trimpot:

1. Set the IR Trimpot to approximately 25% rotation.
2. Run the motor unloaded at approximately 1/3 speed and record the RPMs.

3. Run the motor with the maximum load and adjust the IR Trimpot so that the motor speed under load equals the unloaded speed recorded in step 2.
4. Remove the load and recheck the RPMs.
5. If the unloaded RPM has changed, repeat steps 2 - 4 for more exact regulation. The control is now compensated to provide minimal speed change due to changing loads.

Operation

Set the AC Line Switch to the ON position. Observe that the Pilot Light illuminates. Gradually increase the Main Speed Potentiometer. The motor should smoothly come up to the desired speed and remain stable.

Troubleshooting

The control has LEDs to display the control's operational status.

Power On (PWR ON) LED and Pilot Light

When the AC power is applied to the control and the On/Off AC Line Switch is set ON, the PWR ON LED, on the PC board, will illuminate green and the Pilot Light, on the front cover, will illuminate orange.

Current Limit (CL) LED

The CL LED will illuminate red when the motor is overloaded, indicating that the current limit set point has been reached (set by the CL Trimpot).

Table 2-4 provides information on symptoms, possible causes, and the suggested corrective action for controls without optional forward-brake-reverse switch installed.

Table 2-4 Troubleshooting Guide (without Optional Forward-Brake-Reverse Switch)

Symptom	Possible Cause	Suggested Corrective Action
Motor is not running and Pilot Light not illuminated.	On/Off AC Line Switch in Off Position.	Set On/Off Switch to On Position.
	Blown Line fuse.	Replace Line Fuse.
	Defective On/Off AC Line Switch,	Replace On/Off AC Line Switch.
Motor does not run and Pilot Light is illuminated.	Main Speed Potentiometer set fully counterclockwise.	Rotate Main Speed potentiometer clockwise.
	Defective motor.	Check for defective motor, worn brushes, etc. Replace motor, if necessary.
	Plug-In Horsepower Resistor® not installed.	Install the correct Plug-In Horsepower Resistor®.
	Blown Armature Fuse.	Replace Armature Fuse.
	CL Trimpot set fully counterclockwise.	Set CL Trimpot
Motor hums, runs at very low speed, or slows down substantially when loaded.	Low AC line input voltage.	Check AC line input voltage.
Motor continues to run with Main Speed Potentiometer set fully counterclockwise.	MIN speed trimpot set higher than 0% of base speed.	Readjust the MIN Trimpot.
	IR Comp trimpot set too high.	Readjust the IR Trimpot.
Motor runs in wrong direction.	Motor armature leads are reversed.	Reconnect motor armature leads.

Table 2-4 Troubleshooting Guide (without Optional Forward-Brake-Reverse Switch)

Symptom	Possible Cause	Suggested Corrective Action
Motor will not run in Forward or Reverse direction.	Faulty wiring or loose connections to the reversing switch.	Check and correct connections.
	Forward-Brake-Reverse Switch is defective.	Replace Forward-Brake-Reverse Switch assembly.
No braking action in brake mode.	Faulty connections or loose connections.	Check and correct connections.
	Defective Brake Resistor.	Replace Forward-Brake-Reverse Switch assembly.
Erratic motor performance.	Overload condition.	Remove overload.
	Incorrect Plug-In Horsepower Resistor®.	Install the correct Plug-In Horsepower Resistor®.
	CL and/or IR Trimpots may be set incorrectly.	Readjust the CL and/or IR Trimpots
	Defective speed control module.	Replace speed control.
	Voltage Select Switch set to wrong position.	Recheck line voltage and the correct setting of the Voltage Select Switch.
	Defective motor, worn brushes, etc.	Repair or replace motor.

Optional Accessories

1. Auxiliary Heat Sink (Catalog No. BC143) - Doubles the horsepower rating of the control.
2. Barrier Terminal Board (Catalog No. BC147) - Converts the quick-connect terminals of the control to a barrier terminal block. Contains PC board mounted line and armature fuse holders (fuses supplied separately). Plugs onto the quick-connect terminals of the control.
3. Signal Isolator (Catalog No. BC152) - Provides isolation between non-isolated signal sources and the control. Plugs onto the quick-connect terminals of the control. May also use BC145 Signal Isolator, separately mounted.
4. Dial Plate and Knob Kit (Catalog No. BC149) - Provides indication of the Main Speed Potentiometer position (0 - 100 %).
5. DIN Rail Mounting Kit (Catalog No. BC218)
6. RFI Filter (Catalog No. BC24-LF) - Provides RFI and EMI suppression. Rated 24 Amps at 230 Volts AC, 50/60 Hz. Complies with CE Directive 89/336/EEC (EN55022 and/or EN55011) relating to the EMC Class A Industrial Standard. Remote mountable.